

**Growth of the native pine (*Pinus sylvestris*) at its altitudinal limit in Scotland.**

by

**Jennifer Claire James**

A thesis submitted in fulfilment of the requirements for the degree of Doctor of Philosophy to the University of Edinburgh.

1992



## DECLARATION

This thesis has been composed by myself and it has not been submitted in any previous application for a degree. The work reported within was carried out by myself unless otherwise stated.

## **DEDICATION**

In memory of my mother

## ACKNOWLEDGEMENTS

Firstly, I wish to express my gratitude to Dr. John Grace for his patient supervision throughout my study and for all his help during the preparation of this thesis. I would also like to thank Dr. Douglas Malcolm for reading through and discussing some of the chapters with me.

Secondly, I would like to thank Mr. Andy Gray for carrying out the nutritional analysis described in chapter 4, Mr. Dave Haswell for developing the electron micrographs, Mr. Alec Harrower for technical support and Mr. Bob Astles for keeping my plants watered in the greenhouses.

I would also like to thank Dr. Steve Hoad for all his time and helpfulness around the laboratory and in the field. I am very grateful to all my post-graduate friends who provided invaluable help with fieldwork at a difficult site and especially to Dr. Tarja Lehto and Mr. Ben Werkman.

Finally I would like to thank my father for all his financial support and, together with my sister Susan, for looking after the horses while I was in Edinburgh.

## ABSTRACT

The aim of the study was to investigate factors influencing survival and growth of *Pinus sylvestris* L. at a natural tree-line.

Five experimental stations were set up along an altitudinal transect from 290 m to 675 m at Creag Fhiaclach in the Cairngorm Mountains, Scotland. Three further stations were established in the University grounds at Edinburgh, two of which were inside greenhouses. Thus, a climatological gradient was obtained. Eight 2 year-old *Pinus sylvestris* of Scottish provenance were potted into peat/sand compost and placed at each of the eight stations and measurements of height extension, needle length and fascicle numbers were made during 1989 and 1990. Similar measurements were also made on five native trees at each station along the transect. Air and meristem temperatures were measured and monthly means calculated for all stations.

Mean monthly air and meristem temperatures decreased with increasing altitude. Growth of *P. sylvestris* was found to vary with altitude and can be accounted for at least in part by temperature variation. Height extension, fascicle numbers, percentage needle survival and needle length decreased with increasing altitude, mean height extension and mean number of fascicles being positively correlated with mean meristem temperatures of the previous (May to June) growth season.

Cuticles of needles from all trees measured along the transect were isolated by acid digestion (5% chromic acid) and no significant difference was found in cuticular weight per surface area between altitudes. Results are discussed in relation to the hypothesis of Tranquillini (1979) on the causal relationships leading to winter desiccation of shoots at alpine tree-lines. The hypothesis is considered inappropriate to Scots pine in Scotland.

Needle water potential varied with altitude only in the potted trees related to their age and susceptibility to fluctuating conditions. Needle nutrient concentrations varied significantly with time, needle age and altitude, being higher in valley trees than above the tree-line. Low values were thought to be related to poor nutrient availability, restricted root growth and the effects of low temperatures.

Photosynthetic rates of native *P. sylvestris* were higher in valley trees than in those above the tree-line early in the season due to a developmental lag caused by temperature. By September, rates were higher above the tree-line and plants showed an adaptation of increased quantum efficiency. Percentage needle loss over winter was similar between valley and above tree-line populations, possibly through the effect of frost acting at the lower station.

The relevance of the present study is discussed in relation to other tree-lines and to future predictions of tree growth with respect to climatic warming. Suggestions for further work are proposed.

## CONTENTS

<b>Chapter 1 : Introduction and aims of the study</b>	<b>1</b>
(i) Background	1
(ii) Aims of the study	2
(iii) The native pine in Scotland	6
Scots pine ( <i>Pinus sylvestris</i> L.)	6
(iv) Literature review	10
Tree limits and their fluctuations	10
Causes of tree-lines	12
(v) Physiology of trees at the tree-line	13
Carbon balance	14
Cuticular maturation	16
Winter desiccation	17
(vi) Site description	
Location and characteristics	18
Previous studies	20
(vii) Outline of thesis	24
<b>Chapter 2 : Growth along an altitudinal gradient and its relationship with temperature</b>	<b>27</b>
(i) Introduction	27
(ii) Materials and methods	29
(iii) Results	34
Temperature data	34
Height growth	44
Number of fascicles	46
Needle lengths	48
Rates of growth	50
Maximum growth rates and temperature	53
Relationships with temperature	57
Needle survival	65
Accumulated growth and temperature sum	67
(iv) Discussion	73
Height extension	73
Fascicle numbers	77
Needle length	78
Needle survival	81
General discussion	81

(v)	Conclusions	85
<b>Chapter 3 : Cuticular development of <i>P. sylvestris</i> along an altitudinal transect</b>		<b>86</b>
(i)	Introduction	86
(ii)	Materials and methods	89
(iii)	Results	92
	Needle weight per surface area	92
	Cuticle weight per surface area	92
(iv)	Discussion	103
	Needle weights	103
	Cuticle weights	103
(v)	Conclusions	110
<b>Chapter 4 : Water and nutrients.</b>		<b>111</b>
(i)	Introduction	111
(ii)	Materials and methods	113
(iii)	Results	103
	Needle water potential	116
	Needle nutrient concentrations	120
(iv)	Discussion	137
	Water potential	137
	Nutrient concentrations	140
	General discussion	144
(v)	Conclusions	148
<b>Chapter 5 : Seasonal photosynthesis of current and one year old shoots of native <i>P. sylvestris</i> trees during 1990.</b>		<b>149</b>
(i)	Introduction	149
(ii)	Materials and methods	150
	Photosynthetic rates	150
	Needle survival	159
(iii)	Results	160
	Photosynthetic rates	160
	Needle survival	178

(iv)	Discussion	179
	The seasonal pattern	179
	Interrelationships of needle age classes	181
	Needle survival	184
	Altitudinal effects	185
	Further work	187
(v)	Conclusions	188
 <b>Chapter 6 : General discussion</b>		<b>189</b>
(i)	Altitude and climate	189
(ii)	The altitudinal transect as an 'open-air laboratory'	194
(iii)	Temperature and growth	195
(iv)	The importance of nutrition	197
(v)	Winter desiccation at Creag Fhiaclach	198
(vi)	Some general considerations	198
	Adaptation to the tree-line environment	198
(vii)	Relevance of the study	200
(viii)	Predictions for the future	202
(ix)	Suggestions for further work	206
 <b>References</b>		<b>208</b>
 <b>Appendix I</b> Forestry Commission compost		<b>225</b>
<b>Appendix II</b> Fortran program "DEGREE"		<b>225</b>
<b>Appendix III</b> Composition of leaf cutin acids of <i>P. sylvestris</i>		<b>226</b>
<b>Appendix IV</b> European Pine Model foliar nutrient concentrations		<b>227</b>
<b>Appendix V</b> Worked example of combined curve analysis of variance		<b>229</b>

## CHAPTER 1 : INTRODUCTION AND AIMS OF THE STUDY

### (i) Background

Climatic change is likely to cause major shifts in boundaries between biomes. Rates of warming have been predicted through the use of global circulation models to explore the influence of an increase in atmospheric CO<sub>2</sub> (Pastor and Post, 1988). Some models predict an increase in temperature as rapid as 0.3 °C per decade with simultaneous changes in atmospheric CO<sub>2</sub> concentration and soil moisture through fluctuations in precipitation (Melillo *et al.*, 1990). Impacts of these changes on trees may involve various parts of the life cycle from fertilisation to germination and vegetative growth. Forest response to climate change will partly depend on changes in growth-limiting factors such as water and nutrient availability (Pastor and Post, 1988). Many of the adaptations in respiration, photosynthesis and reproduction found in northern and arctic plants which increase their efficiency at low temperatures may place such species at a disadvantage in warmer climates (Crawford, 1982). Displacement of some species from their present range to higher latitudes or altitudes is probable, resulting in implications for conservation and land use management. Decisions may include whether to allow species to migrate at their own rates within any one area or to impose management plans which may restrict this in some way in an attempt to conserve species already present. In some alpine regions the altitudinal limit of tree growth may be encouraged to extend upwards as trees provide shelter and can act as snow "catchment" areas or as "breaks" and may help to reduce the possibility or impact of avalanches. Rates of change of temperature have been predicted to be more rapid with increasing distance from the equator. In Norway predictions of a temperature increase by the year 2030 of 2 °C and 3 to 4 °C for the summer and winter months respectively, have been made (Grammeltvedt, 1990). Effects of this are thought likely to include a retreat of Norway spruce north-eastwards in northern and Central Europe as slow migration and limited possibilities for genetic adaptation could cause such coniferous trees to decline. Frost-sensitive beech and oak, however, could benefit from these changes and possibly expand to the north and east (Dahl, 1990).

Past vegetational response to change can aid predictions of future responses. Profound vegetational shifts have occurred in the past (Hustich, 1947; Kullman, 1980; Huntley, 1990) although they have been more gradual than those predicted for the future. Variation between regions in post-glacial climate changes suggest decreasing summer temperatures in northern Europe but increasing ones in the Mediterranean region (Huntley, 1990). Forests are likely to undergo large changes, and hardwood forests may be expected to move northwards to areas presently occupied by boreal forest (Gates, 1990). However, since it is doubtful whether species' migration rates will be able to meet the rate of climate shift northwards, any apparent advantages linked to the potential geographical extension of a species' range in one direction should be balanced against losses from the opposite direction and the possible extinction of the species.

In Scotland many vegetational boundaries are artificial, chiefly as a result of a history of forest clearance and the widespread practice of muirburn and grazing and, more recently, large-scale planting of conifers. An important example of a natural tree-line is at Creag Fhiaclach in the western Cairngorm Mountains where the native pine grows at its altitudinal limit. Past fluctuations in the tree limit at this site have been determined from work involving radiocarbon-dating techniques used to age the remains of trees which once grew here (Pears, 1968). Future climatic changes are likely to influence tree-lines in particular as it is within ecotones such as these that trees are already surviving at the edge of their natural range and therefore are likely to be more susceptible than those closer to the centre where a wider margin for adaptation exists.

## **(ii) Aims of the study**

A recent report prepared for the Forest Research Co-ordination Committee suggests the need for basic research into the impact of climate on trees:

"From the evidence presented to us it is clear that there is inadequate understanding of some of the basic physiological processes that govern tree response to existing climates. In particular there is lack of knowledge on the effect of climatic

variables on the annual growth cycle of forest trees, their reproductive behaviour and the partitioning of assimilated carbon" (Anon., 1991).

There are two ways to obtain information of this kind. The first is to conduct controlled environment studies in chambers (growth rooms, open top chambers), and the second is to utilise the natural variation. In the current work, emphasis was placed on the latter. Creag Fhiaclach was chosen as an ideal study site in which to investigate some aspects of the growth of Scots pine and from this to suggest likely effects of climatic warming on future trends. Temperature was selected as the main focus for attention, as the altitudinal gradient provided a range of temperatures onto which an experimental design could be superimposed. Although some increase in temperature may be beneficial to growth the actual increase in future decades may exceed this and be detrimental, possibly resulting in dieback. The effect of a temperature increase on populations adapted to cooler conditions can disrupt their life cycles and phenology (Cannell *et al.*, 1989); for example, the essential winter chilling requirements may not be met and plants may be unable to survive periods of relatively high temperatures and any associated drought.

The main questions posed in the present work were;

### **1. How much does temperature vary with altitude?**

Lapse rates quoted for hills and mountains around the world are often in the region of 5 to 7 °C km<sup>-1</sup> although higher rates have been observed in the Cairngorms in Scotland (Grace, 1977). Variations in these rates may occur and can usually be associated with changes in slope, aspect or topography together with vegetation cover and other shelter. In the present work measurements of air temperature 1 m above the ground were made at five stations along an altitudinal transect. These were compared with values from nearby weather stations (Aviemore and Cairngorm Chairlift). It has been shown by others that plants of low stature experience tissue temperatures above those of the surrounding air (Körner and Cochrane, 1983; Wilson *et al.*, 1987) and therefore air temperatures may not give an accurate idea of the microenvironment of plants at different sites.

Measurements of meristem temperatures were also made to investigate any such differences.

## **2. To what extent is growth determined by temperature?**

Growth measurements under natural conditions provide information on the plant response to its own environment and may therefore enable predictions to be made about the extent of growth expected in comparable regions. Young (2 year-old) *P. sylvestris* trees were placed in pots along an altitudinal transect in the western Cairngorms and their growth was measured at monthly intervals over two years. Similar measurements were made on naturally-occurring *P. sylvestris* at the same stations as a comparison and for information on the natural populations. Measurements of height extension, fascicle number and subsequent survival and needle length were made on all trees.

## **3. Do plants vary in their ecophysiology between altitudes?**

As climatic factors change with increasing altitude, eg. temperature and length of growing season decreases, atmospheric humidity and rainfall increases, plant microhabitats also vary. Timing of budbreak, period of maximum growth and needle extension and rate of photosynthesis may differ between elevations. Adaptations to individual microenvironments may be shown in the physiology of the plants growing there. For example, for seedlings of rowan (*Sorbus aucuparia*) from Scotland the mean relative growth rate has been shown to increase with increasing altitude (Barclay and Crawford, 1984), which may be an adaptation to complete growth within a comparatively short time period. A similar conclusion of adaptation to an unfavourable environment was reached concerning *Pinus montana* seedlings when respiration was found to be higher on a north- than a south-facing slope (Häsler, 1982). To investigate some aspects of the ecophysiology of trees in relation to altitudinal variables measurement of several aspects of growth and development on groups of these trees were planned including growth and photosynthesis. The water potential and nutrient content of needles from both potted and native trees were determined at regular intervals throughout one growing season. It was postulated that some insight into the effects of edaphic variation could be incorporated into the study in this way as soils are frequently

more shallow at higher altitudes or on hilltops and contain less nutrients than those below. Measurements of photosynthetic rates of current and one year-old pine shoots were planned on two populations of native trees, making a comparison between a valley population and one just above the tree-line to determine any altitudinal effects. The extent of cuticular development and its relation to winter desiccation is considered by many authors to be very important in alpine conditions. Cuticular weight per surface area was therefore determined for the potted trees at regular intervals throughout one growing season to investigate the effect of altitude on cuticular development.

#### **4. What are the likely causes of the current position of the tree-line?**

Having proposed to collect data on the variables mentioned, it was considered that some suggestions might emerge as to the reasons for the current position of the tree-line at this site. Variation between plants growing at different altitudes might show correlations to climatic data which, in turn, may be directly influencing any physiological patterns observed. Seed viability has been found to decrease with increasing altitude of the seed source for *Sorbus aucuparia* in Scotland (Barclay and Crawford, 1984). Since altitude influences both seed size and viability, possibly as a result of decreasing length of the growing season with elevation, the position of some tree-lines could be determined, at least in part, by lack of regeneration above a certain level.

Alternative hypotheses for the position of tree-lines include direct and indirect effects of climate and soil which prevent trees from becoming established or surviving beyond the upper extent of the tall forest. (These will be discussed in more detail later). In managed areas, grazing, burning and planting are additional factors which may be significant.

#### **5. What predictions can be made about the impact of climatic change?**

Predictions concerning the future of Scots pine following climatic change may be possible to some extent using results obtained in this study. Environmental lapse rates in conjunction with altitudinal adaptations could be used to estimate increases

or decreases in aspects of growth under given temperature changes. For example, if needle length was known to be primarily correlated with air temperatures, some values of needle length could be predicted for a given range of air temperatures and an estimation of increase could be made in relation to predicted temperature changes. However, it should be remembered that the value of any such predictions made from the data obtained in the present work may be limited to Britain, this mountain range (the Cairngorms), or even to this site alone.

### (iii) The native pine in Scotland

#### *Scots pine (Pinus sylvestris L.)*

Pines (*Pinus*) are the largest and most widespread genus of conifer, with more than one hundred species in all the temperate and subtropical areas of the northern hemisphere (Mitchell and Wilkinson, 1982). They are native to Europe, Asia, North America, Central America, North Africa and to the respective proximate islands (Dallimore and Jackson, 1966). Pines differ from other conifers in that their leaves are borne in bundles of two, three or five; the majority of northern species being two-needled.

Scots pine (*Pinus sylvestris*) is a two-needled pine and is the only species which is indigenous to Britain. It has a wide natural distribution range from north-west Spain (7 °W) to East Siberia (138 °E) and from south-east Spain (37 °N) to northern Norway (70 ° 29 ' N). A map of the natural distribution in Europe and Asia can be found in Steven and Carlisle (1959). Figure 1.1 shows the natural distribution of *P. sylvestris* in Western Europe. Within its range *P. sylvestris* tolerates a variety of climatic conditions and withstands mean temperatures from -27 °C in the north in winter to summer temperatures of between 22 and 26 °C in south-east Spain. It is a tree of marginal regions and grows well on poor, acid soils which can provide it with a competitive advantage over other species. Seedlings are shade-intolerant and open stands are formed, commonly with a well established understory of *Calluna/Vaccinium* communities.

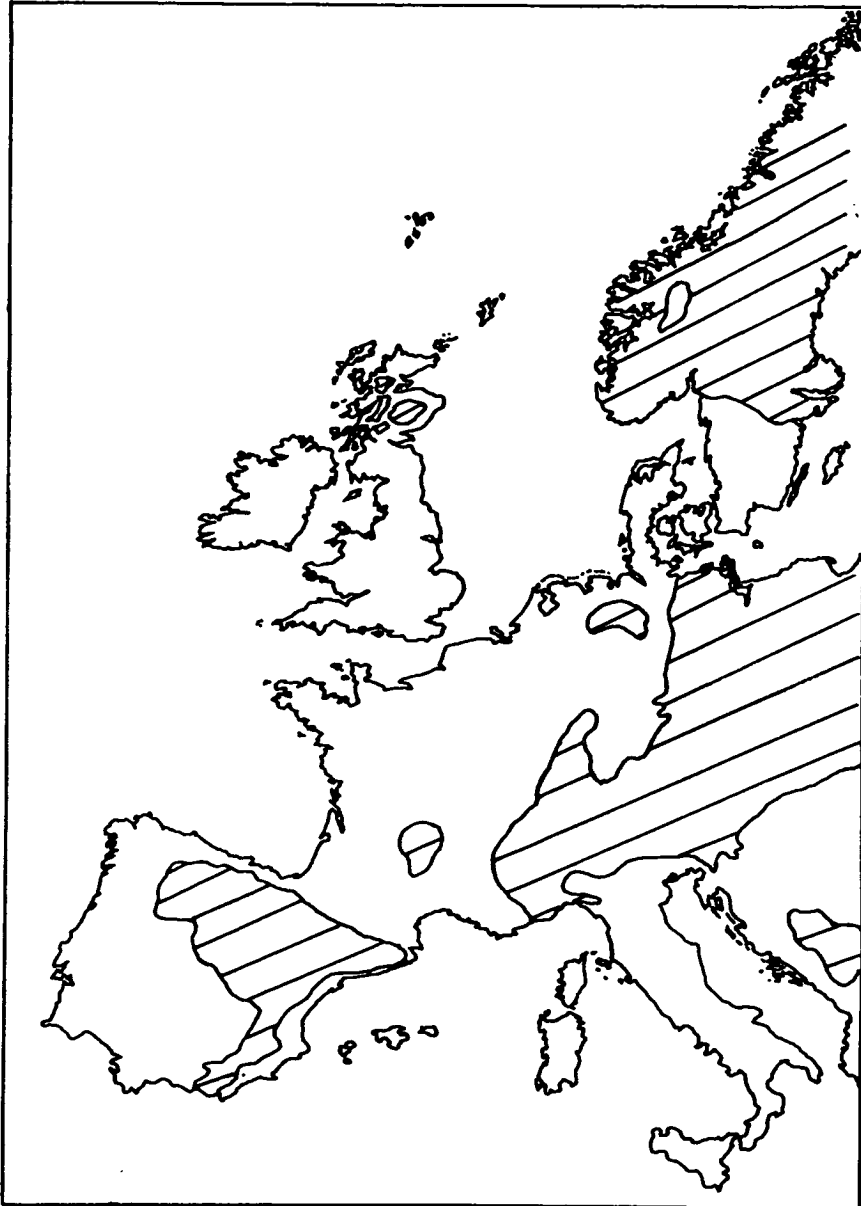

**Figure 1.1 :** The natural distribution range of *Pinus sylvestris* (shaded areas) in Western Europe (scale 1:24 000 000). Redrawn from Steven and Carlisle (1959).

*P. sylvestris* is a tree of monopodial growth with branches produced in whorls, although a variety of forms can be found from spire-like crowns to bushy trees with no main axes (Carlisle and Brown, 1968). The needle-shaped leaves occur in pairs surrounded by a pale, grey-brown sheath at the base, the whole structure being described as a fascicle. The needles have a characteristic twisted appearance and are generally between 30 and 80 mm in length and between 1 and 2 mm in width (Steven and Carlisle, 1959; Carlisle and Brown, 1968). They usually remain on the tree for three to four years although much greater longevity (up to 10 years) has been observed in northern Sweden and Russia (Pravdin, 1969).

The geographical distribution of *P. sylvestris* throughout the Holocene period has been mapped using data from pollen analyses and from radiocarbon-dating of pine macrofossils that have been preserved in peat. Some basic patterns in the distribution since the last glaciation are shown in Table 1.1 in increments of 1,000 years (Huntley and Birks, 1983).

*P. sylvestris* was present in southern England before 9,000 B.P. and had spread to central England, southern Cumbria and the northern Pennines by 8,500 B.P. (Birks, 1989). It expanded into Wales between 8,400 and 8,100 B.P.. The work of various authors suggests that the spread of Scots pine in north-west Scotland was independent from that occurring northwards from southern England. Birks (1989) suggested, using isochrone maps to examine its range-dynamics, that there had been as many as three independent centres of origin of pine within the British Isles. Birks (1972) found that very few similarities existed between pollen diagrams from north-west Scotland and those from southern Scotland, England and Wales and that the time of expansion of pine differed between the two regions. She dated pine stumps in the north-west Highlands at between 4,500 and 4,000 B.P. and those in the south and east at about 6,000 B.P. (Birks, 1975). Monoterpene and isozyme analysis have shown populations from the two regions to be genetically distinct (Kinloch *et al.*, 1986). These authors suggest that pine may have originated "endemically from more than one refugium" since the last glaciation.

Pine expanded regionally in north-west Scotland between 8,500 and 8,000 B.P. and then moved east (8,000 to 7,500 B.P.) to Upper Speyside and Upper Deeside (Birks, 1989). By 6,000 B.P. the southern margin had extended to the Rannoch Moor area and by 5,000 B.P. pine had expanded north into Sutherland and west to

**Table 1.1 :** Some historical distribution patterns of Scots pine (*Pinus sylvestris*) in Europe. Data from pollen analysis (Huntley and Birks, 1983).

---

Date	Distribution
13,000 B.P.	N. Italy & Romania
11,000 B.P.	N. Spain (mts.), N.E. Europe (lowlands)
10,000 B.P.	only absent in Fennoscandia & Britain
9,000 B.P.	reached Scandinavian uplands
8,000 B.P.	reached Finland
7,000 B.P.	northernmost Fennoscandia
6,000 B.P.	declined in Fennoscandia
5,000 B.P.	restricted in Alps, dominant in N. Finland & Bulgarian mts.
4,000 B.P. to 3,000 B.P.	declined in Scotland & S.W. Ireland
2,000 B.P.	expanded in N.E. Europe & Spain
1,000 B.P.	fragmentation of forests in N. Scandinavia

Skye. Pine also extended altitudinally (6,000 B.P) in the eastern Grampians and in the Cairngorms (Dubois and Ferguson, 1985 (unseen) cited by Birks, 1989). Pine populations declined around 4,000 B.P. in western Scotland but not in the eastern Highlands (Birks, 1989).

Reasons for the variation in density and distribution of pine woodland in Scotland during the Holocene have been postulated, for example long-term precipitation variations (Bridge *et al.*, 1990) and large scale climatic changes (McVean, 1963). Clearly the patterns of spread and colonisation of *P. sylvestris* both latitudinally and altitudinally are complex and the causes of such historical changes, speculative. The most probable factors involved include climatic and edaphic fluctuations in combination with the genotypic and phenotypic adaptability of the trees and any effects of interspecific competition. A further point to note is that the data-collection methods, namely radiocarbon-dating of pine macrofossils, involves bias as acidic peat mire, from which records are obtained, may actually have been an atypical ecological niche (Bridge *et al.*, 1990).

#### **(iv) Literature review**

##### ***Tree limits and their fluctuations***

Under natural conditions the distribution of trees is primarily limited by climatic conditions and can be grouped according to latitude and altitude. The upper limit of tree growth often coincides with the 10 °C summer (July) isotherm, ie. the altitude at which the mean temperature of the warmest month is 10 °C (Köppen, 1931; Daubenmire, 1954). The global rise in temperature since 1900 has caused a corresponding rise in the snowline (800 m in Peru) and in timberlines (as much as 20 m since 1930 on some mountains in Sweden) (Barry and Chorley, 1968). Much of the work on the dynamics of these limits has involved radiocarbon-dating of macrofossils preserved in peat and pollen analysis (as mentioned earlier). Other approaches have included dendrochronology which can be used to determine historical climate trends and their influence on tree growth (Hustich, 1947; Mikola, 1962; Schweingruber *et al.*, 1979; Grace and Norton, 1990).

Studies by Kullman (1988) in the Scandes Mountains in Central Sweden have identified five distinct climatic episodes that occurred in the Holocene period;

- 6,300 B.P. - short-term deterioration
- 6,100 B.P. - a Holocene thermal optimum
- 5,300 B.P. - deterioration
- 3,300 B.P. - deterioration
- 800 B.P. to
- 300 B.P. - deterioration

In the Scandes, Scots pine and Norway spruce (*Picea abies* (L.) Karst) alternate as dominants in the coniferous boreal forest below an altitudinal belt of mountain birch (*Betula pubescens* Ehrh. ssp. *tortuosa* (Ledeb.) Nyman), the tree-limit (uppermost individual taller than 2 m) of which reaches 880 m. Today, scattered individuals of Scots pine reach 720 m whereas during the thermal optimum (6,100 B.P.) this species is thought to have been present 200 m higher (Kullman, 1988). A similar observation was made by Kearney and Luckman (1983) in Jasper National Park, Alberta, Canada where a maximum displacement of 200 m for timberlines during the last 8,100 years was found.

The altitudinal limit of tree growth varies between climatic regions. Western Europe is an extensive land area with a temperate maritime climate; to the west lies the cool, temperate, maritime of the British Isles, east of which there is a gradual change to a more continental climate. The characteristic seasonal changes are determined by the annual march of net radiation and temperature (Lockwood, 1974). In winter, temperatures fall well below freezing in the more continental regions but remain above 0 °C on average in most of west and north-west Europe and on the Mediterranean coasts (Lockwood, 1974). The steepest temperature gradients occur between latitudes 65 and 70 °N.

The tree limit is generally found at much higher altitudes in the mountains of the rest of Western Europe than it is in Britain. Tansley (1965) stated that above 1,000 m in the Scottish Grampians 27 % of the species are chamaephytes compared to 9 % in the flora of the world as a whole. Such differences may be due to the dominance of maritime polar air with strong winds, frequent low cloud and steep lapse rate as compared to the lighter winds and clearer skies further east

(Lockwood, 1974). Some examples of the elevation of tree limits are shown below.

Eastern Alps, Austria	<i>Pinus cembra</i> and <i>Picea abies</i>	2,140 m
Scandes mountains, Central Sweden	<i>Pinus sylvestris</i>	700 m
Central Swiss Alps, Switzerland	<i>Pinus montana</i> and <i>P. cembra</i>	2,020 m
Craigieburn Range, New Zealand	<i>Nothofagus solandri</i>	1,300 m
Cairngorm mountains, Scotland	<i>Pinus sylvestris</i>	590 m

### *Causes of tree-lines*

The term 'tree-line' has been used to describe several different limits of tree growth in the past. Throughout the present work 'tree-line' (at Creag Fhiaclach) refers to the altitudinal limit of tree growth above which only scattered, isolated individuals occur of less than 1 m in height. Causes for the position of tree-line have been suggested by several authors; temperature, wind, precipitation and the developmental stage of the trees at the onset of winter being the major ones. Frequently a combination of the effects of these factors has been considered and the influence of such combinations differs from place to place.

Climatic and topographic variations between sites can result in the position of tree-lines at different elevations from country to country (as mentioned previously). On a smaller scale this elevation may change between valley heads and spurs within the same range (Pears, 1968) or between aspects of the same slope (Turner *et al.*, 1982). In such cases temperature and wind are usually the most important influencing factors and can fluctuate over very short distances. In the Derbyshire Dales in England mean <sup>daily</sup> air temperatures have been found to vary up to 3 °C between aspects within a valley (Rorison *et al.*, 1986).

The effects of wind on the position of tree-lines has been considered both in terms of its direct pressure causing bending and breakage, its drying effects through lowering plant-atmosphere boundary resistances (Grace, 1977; 1983) and through the impaction of wind-blown particles causing surface damage (van Gardingen *et al.*, 1991). Wind is also directly linked to the effects of temperature as an increase

in windspeed will result in lower aerodynamic resistance to heat transfer and consequently lower plant surface temperatures (Wilson *et al.*, 1987). Since trees such as Scots pine decline in stature above the tree-line, and a low growth form is known to provide protection from wind and low temperatures, it is implied that taller trees would not survive here and that these are therefore the two climatological variables that are primarily determining the position of the tree-line. However, temperature and wind cannot be considered in isolation for reasons already mentioned. Precipitation differences between geographical regions also contribute in a variety of ways. British uplands have a rich bryophyte and lichen flora by European standards (Grace and Unsworth, 1988) as a result of their comparative wetness.

Depth and duration of snow cover is generally less in upland Britain than in other European mountain regions and the less extreme climate results in winter soil and air fluctuations around 0 °C which cause freeze-thaw stresses on plants. However, these effects acting on transpiration and photosynthesis may be compensated for to some extent by comparatively lower inputs of radiation, high radiation loads in late winter in alpine environments being a cause of desiccation (Tranquillini, 1964; 1979).

#### **(v) Physiology of trees at the tree-line**

Two main views concerning the factors that determine the alpine tree-line have been presented in various research studies. These are firstly that summer temperatures through their influence on growth determine the upper limit of tree growth (Michaelis, 1934 (unseen) cited by Tranquillini, 1979), and secondly that winter desiccation, as a result of excess transpiration when soils are frozen, is the most important determinant. A combination of these views has also been proposed (Wardle, 1971; Tranquillini, 1979) in which the survival of trees is centred on the developmental stage of the leaf cuticles at the onset of winter, this being determined by summer conditions. Overwinter desiccation, and hence subsequent survival, can then be related to these conditions as the less well-developed cuticles will be more susceptible to water loss.

Perhaps the most comprehensive study to date is that by Tranquillini (1979) who considered the causes of the upper survival limit of trees on mountains with seasonally fluctuating climates under the following three headings;

- 1) Negative carbon balance
- 2) Arrested phenological cycle
- 3) Inadequate resistance to deleterious factors

In the current section his overall hypothesis is considered step by step in relation to the present study.

### *Carbon balance*

Many factors influence the carbon balance of trees at tree-line, some promoting and others limiting carbon gain. Generally, high photon flux densities and high air and soil moisture promote photosynthesis. These characteristics are commonly found at tree-lines where sparse shelter means few shade areas. In maritime regions frequent low cloud and mist contribute to high relative humidities and precipitation. Physiological and genetic adaptation can also enhance photosynthesis. In the current work measurements of photosynthesis were made on two distinct populations, separated by an elevation of 310 m, to obtain an idea of the rates attained at different times of the year and to discover any differences which might result from the influencing factors stated.

Information on the number of leaves and leaf size can provide some insight to photosynthetic rates achieved by trees since the product of leaf area and photosynthetic rate form the photosynthetic production per plant. This production is therefore influenced indirectly by temperature as previous summer temperatures and current summer temperatures are related to the number of needles produced, and the length of those needles, respectively (Junttila, 1986).

Maintenance of leaf area from one year to the next is of major importance since it is primarily the previous year needles which provide the carbon assimilates for the growth of the current year needles. Survival of needles overwinter is therefore a chief factor determining the position of tree-lines and has been measured in the

present work. Leaves can be seen as a store for reserves and in regions where carbon or essential nutrients are limiting to growth, by prolonging leaf longevity the potential return on investment is increased (Crawford, 1989).

Factors which may limit carbon gain include the opposite of those already mentioned that promote it (ie. low radiation levels, low air and soil moisture and poor adaptation) together with strong winds, short growing season and frosts during this season. These last factors are of particular significance at tree-lines since low temperatures provide relatively little opportunity for growth and there may be only a few months available in which maximum rates of photosynthesis can be achieved. In alpine regions low atmospheric carbon dioxide content can also be important, and in addition photoinhibition, resulting from damage induced under high photon flux densities, may limit carbon gain.

Dry matter production is also limited by dark respiration where carbon dioxide and water are lost to the atmosphere. Dark respiration has been found to increase significantly with increasing altitude of origin for detached buds of *Sorbus aucuparia* and is thought to be primarily controlled by climatic variables (Barclay and Crawford, 1984). In regions of high radiation, trees, especially dwarf forms, may experience high tissue temperatures as much as 15 °C above ambient (Wilson *et al.*, 1987). Such temperatures can promote stem and root respiration and are of particular significance in winter when soils are frozen and water uptake is restricted. However, some compensation for this loss of carbon may occur since low air and soil temperatures can reduce respiration rates by lowering metabolic activity. Also at high altitudes plants may have relatively greater photosynthetic efficiencies and so under cool conditions this loss of carbon may be less important. Photosynthesis can also be affected and photoinhibition is thought to be widespread in conifers in cold climates (Öquist and Huner, 1991), especially so at the start and end of the growing season. Such limitations to photosynthesis contribute negatively to the total annual carbon balance and may put further restrictions on the length of the growing season.

The reduction in organic matter with altitude may be such that trees at the tree-line have not only smaller leaf areas and hence lower photosynthetic production than those at lower elevations, but also smaller storage and transport capacities and possibly deficient mineral and water supplies through poorly-developed root

systems. In *krummholz* growth forms (the term "krummholz" is used in the present work to refer to short, stunted tree forms at, and above, the tree-line and not to genetically distinct individuals as defined by Holtmeier, 1981) the total amount of thick, twisted stems compared to leaf area may increase the ratio of dark respiration to photosynthesis due to the relatively high mass of non-photosynthesising tissue (Rutter, 1957). In addition, seed size, number and dispersal are likely to be restricted at the tree-line which, in turn, may restrict regeneration capacity.

### *Cuticular maturation*

The relatively short growing season at the tree-line restricts the time available in which leaf cuticles may develop. An especially short season resulting for example from below average temperatures or high cloud cover may be insufficient for development to be completed. In this case leaves enter the winter season without sufficient protection against desiccation, and damage or loss (possibly of the whole plant) may result. Tranquillini (1979) described this situation as one where -

"the phenological cycle and the associated acquisition of resistance are no longer synchronised with the climatic rhythm".

From studies involving measurement of cuticle thickness (Tranquillini, 1974; Baig and Tranquillini, 1976; Platter, 1976 (unseen) cited by Tranquillini, 1979) he suggested that incomplete development of shoot primordia and thinner cuticles are widespread among trees at the tree-line. Taking this into account measurements of cuticular weight per surface area were made in the current work at intervals during a growth season for trees at a range of altitudes including some at and above the tree-line in Scotland.

Climatic factors detrimental to conifer needles include low temperatures, frost, wind, high radiation and low atmospheric water vapour pressure. For needles with poorly-developed cuticles these factors may be of even greater significance. Wind can act in two main ways; mechanical damage and through wind-blown particles. The former includes breakage or weakening of needles, branches or stems and may result in the loss of substantial parts of the tree. It also involves rubbing between

plant surfaces either of adjacent plants or within a single plant as trees are buffeted by air movement. The latter can cause abrasion of the epicuticular waxes on the needle surfaces (van Gardingen *et al.*, 1991). Both loss of plant parts and surface abrasion will ultimately reduce the total leaf area, thereby reducing potential photosynthetic area, nutrient and carbon reserves.

Sites of damage provide routes for water loss and cuticle abrasion reduces resistance to transpiration. Tranquillini (1979) attributed the resulting cuticular water loss to high atmospheric evaporative demand during winter under conditions of high radiation, leaf temperature and wind, and low atmospheric water vapour pressure. He stated that the subsequent frost-desiccation damage was greatest on poorly-developed shoots. An alternative hypothesis is that abrasive damage to leaf surfaces disrupts the turgor relations within the epidermis and leads to stomatal dysfunction (Grace, 1990). Cuticular conductance of *P. sylvestris* in Britain has been shown to increase with altitude (Grace, 1990) and to decrease as water vapour saturation deficit increases (Beadle *et al.*, 1985b). The optimum temperature for stomatal conductance of current year needles of mature (45 years old) Scots pine is approximately 20 °C and is within the optimum leaf temperature for photosynthesis (18 to 22 °C) (Beadle *et al.*, 1985a). However, these authors suggested that the two variables (stomatal conductance and photosynthesis) may act independently.

### ***Winter desiccation***

Excess loss of water from trees at the tree-line is particularly important during the winter months when low temperatures are prevalent and soils are cold or frozen. Although trees at tree-lines are often well-adapted to sub-freezing temperatures, eg. northern hemisphere subalpine pines show freezing resistance up to -70 °C (McCracken *et al.*, 1985), damage can be frequent especially to current year foliage, and browning of needles ("*Frostrocknis*") common. Tranquillini (1979) describes the cause of injury as the coincident timing of frost and desiccation with growth phases at a stage of incomplete resistance.

The influence of climate is likely to be very strong in relation to winter desiccation. High radiation may promote photosynthesis and increase tissue temperatures thereby increasing respiration. Under these circumstances stomatal

conductance can reduce the water content of the plants since cold or frozen soils restrict water uptake and thus restrict replacement of losses. This combination of factors will vary from site to site and notably so between climatic regions, being more frequent in continental areas where winters are longer and more severe.

Excessive water loss from the shoots of trees at their upper limit can therefore be seen to occur as a chain of events rather than a single process in winter, beginning with a short growth season limiting to development. Whilst timing of internal and external factors may determine the extent of resulting damage or injury to any plant the actual factors involved may vary in importance from region to region and it is unlikely that the position of all tree-lines occur from the same causes.

## **(vi) Site description**

### *Location and characteristics*

Creag Fhiaclach (Grid ref: 855053) is a north-west facing site in the Cairngorm Mountains of Scotland (57° 08'N 3° 50'W). It is situated 7 km due south of Aviemore at the western edge of the Cairngorm National Nature Reserve (established in 1954). It is a steeply-sloping, rocky site on which grows one of the few remaining areas of native pine forest. The tree-line here is thought to be at its full potential in elevation (Pears, 1968), undisturbed and possibly unique in Britain (Miller and Cummins, 1982).

The Cairngorms form part of the north east Grampian Mountains and are formed largely of pink granite (intrusions into Caledonian schists) with coarse soils of low fertility (figure 1.2). In contrast to other British mountains they contain a large, continuous area of natural alpine vegetation which has survived as a result of low fertility and generally harsh conditions, factors which have discouraged exploitation of the region. Within Britain the Cairngorms lie in an area of relatively continental climate with more extreme annual temperature ranges but less extreme rainfall than in the Western Highlands (Nethersole-Thompson and Watson, 1981). However, on a European scale the climate is oceanic and is characterised

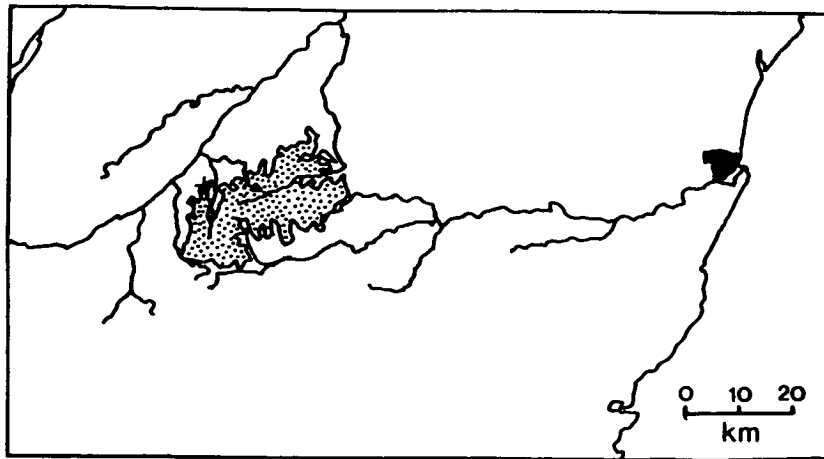

**Figure 1.2 :** Maps showing the location of the field site (+) within the British Isles (upper) and within the Cairngorm Mountains of Scotland (lower). (▲; Cairn Gorm, 1 245 m).

by a marked vegetation zonation resulting from steep altitudinal gradients of temperature and windspeed.

Over the Cairngorm area mean values for daily sunshine hours are 1 to 1.5 in December and less than 5.5 in June. The nearest weather stations to Creag Fhiaclach are located at Aviemore (229 m) and the Cairngorm Chairlift (663 m). Although data are available for the months corresponding to the present study these stations were only established in 1982 and 1981, respectively (Meteorological Office, pers.comm.) and therefore no long-term means are available. Another nearby station (closed in 1987) was situated at Lagganlia (250 m) with a 30 year average for mean annual temperature of 6.7 °C (1971-1986). The closest station for which a long-term mean annual rainfall figure is available is Glenmore Lodge (341 m) with a value of 1,024 mm (1951-1980), and for snow, Braemar with a value of 59 days (snow lying at 0900 hrs). At 300 m at Creag Fhiaclach the mean <sup>monthly</sup> temperatures range from 1.5 °C (January) to 13 °C (July) with a mean annual precipitation of 1,200 mm and wind speed of 4 to 6 m s<sup>-1</sup> (estimated by Miller and Cummins, 1982).

At Creag Fhiaclach (figure 1.3) *Pinus sylvestris* grows as tall forest with an open canopy between 400 and 570 m. Above this (590 m) it forms a natural *krummholz* tree-line with juniper (*Juniperus communis* L.) scrub. Below 400 m the large trees remaining are those that were left when felling took place in the 1940s (Grace and Norton, 1990). Stumps are visible amongst the heather (*Calluna vulgaris*) which covers the valley floor and also some regeneration of pine.

Further details and descriptions of the site can be found (Poore and McVean, 1957; Pears, 1967; Miller and Cummins, 1982), the earliest of which are by Watt and Jones (1948).

### ***Previous studies***

Considering its importance, relatively few scientific studies have been carried out at this site. One of the more recent was by Wilson *et al.* in 1987 who measured net radiation, air temperature, humidity, windspeed and apical meristem temperatures. These measurements were carried out along an altitudinal transect

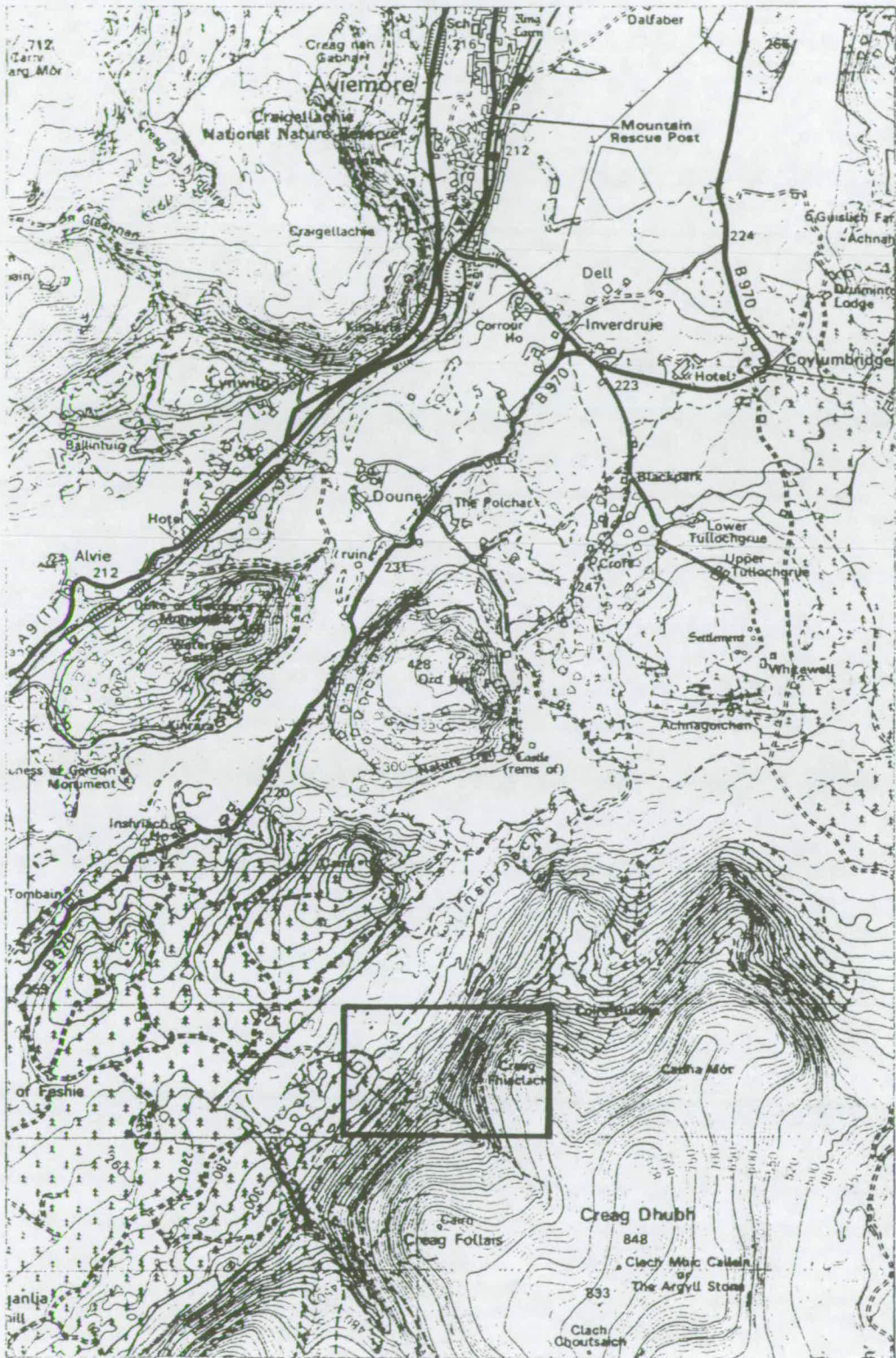

**Figure 1.3 :** The position of Creag Fhiaclach in relation to Aviemore and the surroundings (scale 1:50 000).

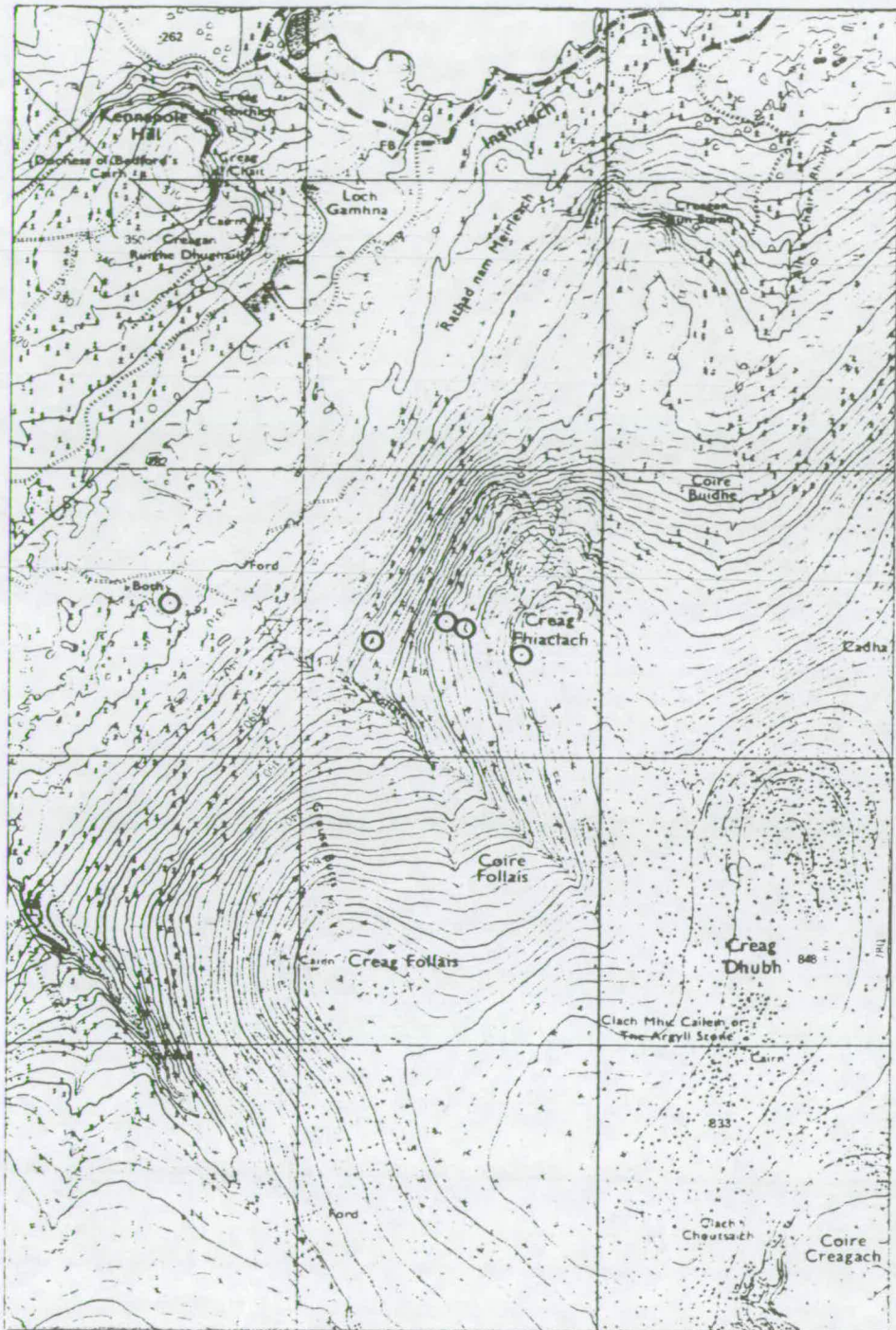

**Figure 1.4 :** Crag Fhiaclach showing positions of the measurement stations (scale 1:25 000).

close (north-east) to that of the present work (which is shown in figure 1.4). The lapse rate measured along this transect was  $9\text{ }^{\circ}\text{C km}^{-1}$  which is higher than in other parts of the world (Grace, 1977). Dwarf forms of vegetation were found to experience larger temperature differentials between surface and atmosphere than the taller forms due to their relatively higher aerodynamic resistance. Such differences were smaller on windy or dull days.

Later a growth-ring study on climate and growth of *P. sylvestris* was carried out here (Grace and Norton, 1990). These authors found temperature to be more important than rainfall in influencing radial stem growth with both late-winter (January to February) and summer (July to August) temperatures significantly and positively correlated with ring-width. They also showed that the ring-widths of *krummholz* trees at the tree-line were less strongly correlated with climatic factors and were, unexpectedly, greater than those of trees at lower elevations. The extent of winter browning was thought to be the possible cause of the correlation with winter temperatures. Another study on this site involved measurements of morphological characteristics of pine needles with respect to altitude. Needles from high altitudes, from both old *krummholz* and young trees, were found to lose water more rapidly than those at low altitude (Grace, 1990). This was attributed to stomatal dysfunction resulting from mechanical damage to the leaves and direct damage to the cuticles.

Prior to these studies the major work carried out in the area was that of Pears (1967; 1968; 1988) and Miller and Cummins (1982). The most notable of these is that of Miller and Cummins (1982) which was on Creag Fhiaclach itself. In this work 23 belt transects (2 m x 300 m) along randomly chosen contours between 530 m and 750 m were used in which distribution and density of all species of trees and shrubs were recorded. Seedlings and small saplings beneath the dwarf shrub canopy were recorded within thirty quadrats thrown in each transect. The age, density, distribution and reproductive capacity of Scots pine were estimated. For individual trees, age varied from 50 to over 300 years, the forest trees being 53 years older than those of the pine-juniper scrub above 530 m. For saplings no significant differences were found between the mean ages in different zones except that plants in the pine-juniper scrub were older than those elsewhere. No pine sapling was found above 31 years of age. Saplings and the surrounding vegetation were found to decrease in height with increasing altitude.

A long-term seedling (*P. sylvestris*) survey was carried out in the Cairngorms in 1964 and repeated in 1986 (Pears, 1988). Pears concluded that pine seedlings ranged in age between 2 and 20 years (mean 8 to 9 years) and that they do not survive for more than 20 years on the N.N.E.-facing slopes of Creag an Leth-choin (a site approximately 8.4 km E.S.E. of Creag Fhiaclach) between 550m and 915 m

Miller and Cummins (1982) found that pines were actively regenerating only in the pine-juniper scrub and seed-fall at the tree-line was sparse compared to lower forests. The extent of browsing was thought to be greater in the pine forest and less above. The effects of altitude and exposure were considered to be more restricting to the activities of herbivores between 531 m and 590 m than to the development of trees to reproductive maturity. The authors suggested that further zones of self-regenerating pine-juniper scrub might be created at around 600 m elsewhere in the Cairngorms if sufficient seeds or seedlings were introduced.

#### **(vii) Outline of thesis**

**Chapter 2 :** Growth along an altitudinal gradient and its relationship with temperature.

Five field stations were set up along an altitudinal transect in the Cairngorm mountains and three stations in the University grounds in Edinburgh. Eight 2 year-old *P. sylvestris* trees were placed in pots at each site. Measurements of height extension, needle length, fascicle numbers and subsequent survival were made on all plants and on five native trees at each of the Cairngorm stations. Measurement of mean air and meristem temperatures were made using thermistors and thermocouples, respectively, all of which were connected to dataloggers. The experiment was set up and run for two years (1989 and 1990) after which time the potted trees were carefully uprooted and brought back to the Edinburgh stations. Results were analysed in terms of growth and temperature relationships with altitude.

**Chapter 3:** Cuticular development of *P. sylvestris* along an altitudinal transect.

Current year fascicles from the potted trees along the transect were sampled at monthly intervals from June to October in 1990 and needle weights per surface area were calculated. Cuticles were isolated by acid digestion and cuticular weights per surface area were determined. The relationships between cuticular weight per surface area with time and with altitude were investigated. Results are discussed with reference to winter needle loss through desiccation.

**Chapter 4 :** Water and nutrients.

Fascicles were sampled from the native and potted trees at all stations along the transect prior to and during the growth season in 1990 and their water potentials were determined. All needles were then analysed for concentrations of N, P, K, Ca and Mg. In conjunction with measurements of photosynthetic rates (chapter 5), current and one year-old needles from two populations of native trees (290 m and 600 m) were sampled in June, September and November (current year needles only) and their nutritional concentrations were determined in the same way. All results (water potential and nutritional analysis) were then analysed for significant variation with respect to time, altitude, and in the case of the native trees, needle age.

**Chapter 5 :** Seasonal photosynthesis of current and one year-old shoots of native *P. sylvestris*.

Measurements of photosynthetic rates were made on two distinct populations, one above the tree-line (600 m) and one in the valley below (290 m), in June 1990. The leaf area per shoot was calculated and the needles were analysed for nutrient concentrations (see chapter 4). The measurements were repeated in September, and then in November for the current year shoots. Results were analysed for any significant variation between the populations, the needle ages and with the time of season.

## **Chapter 6 :**      General discussion.

The relationship between altitude and climate is described and some comment is made on the validity of an altitudinal transect as an 'open-air laboratory'. The results of the present study are discussed with reference to a reconsideration of Tranquillini's hypothesis. The relevance of this study and predictions for future change at Creag Fhiaclach are postulated. Some suggestions for further work are proposed.

## CHAPTER 2 : GROWTH ALONG AN ALTITUDINAL GRADIENT, AND ITS RELATIONSHIP WITH TEMPERATURE

### (i) Introduction

As shown in the previous chapter, temperature is often considered to be the main factor influencing the position at which tree-lines occur; growth above such a position being limited directly by the effects of low temperatures at some stage in the year.

According to Carlisle and Brown (1968), *Pinus sylvestris* requires temperatures exceeding a threshold of about 5 °C to initiate extension growth in the spring after a winter chilling to break bud dormancy. The number of needles produced each year can be related to the temperatures experienced by the plant in the preceding growth season since it is during this time that the number of stem unit primordia are determined within the developing bud (Junttila, 1986). Total needle elongation, however, is more closely related to the current year's temperatures (Mikola, 1962). Since pine needles grow from basal, intercalary meristems on lateral bud primordia their growth is separated in time from their initiation and differentiation which determines the number of stem unit primordia (Cannell *et al.*, 1976).

Relationships between the number of degree days above a certain threshold and the onset, duration and cessation of the elongation period have previously been found for pines (Sucoff, 1971, Junttila, 1986). Although this approach to relating temperature and plant development has been widely used in the literature, it may not always be appropriate. It relies on a linear relationship between the rate of the underlying biological processes and temperature. Many biological and biochemical processes have a near-linear rate in the range 5 - 15 °C, but beyond that their rate increases less rapidly with temperature, eventually declining at supra-optimal temperatures. It may be assumed that plant development is the integration of a large number of processes of this kind. In generally cold environments, the plant is likely to be operating for most of the time in the near-linear range, and so it may then be possible to relate the accumulated development (or growth) to the accumulated temperature.

Diameter or radial growth of trees is also limited by temperature (Tranquillini, 1979, Norton, 1984, Grace and Norton, 1990). Generally the effect of temperature is through its influence on the length of the growth season both directly, determining onset and cessation of growth, and indirectly by affecting photosynthesis and hence the amount of dry matter accumulated within the plant.

As temperature is known to decline with increasing elevation at a fairly constant rate within any one area, it may be possible to relate growth characteristics of trees to temperature by reference to altitude. Differences in the timing and duration of growth periods between altitudes can result in developmental lags occurring between plants growing at higher sites and those at lower elevations. The comparatively short growing season at high altitudes has been proposed as a major cause of the position of tree-lines, setting the limit at which trees can survive (Tranquillini, 1979).

In the present work it was decided to explore the relationship between growth and temperature by measuring growth along an altitudinal gradient.

The null hypotheses in this part of the work were as follows;

$H_0$  : *Pinus sylvestris* grows equally at all altitudes.

If this hypothesis is rejected, the further null hypothesis is

$H_0$  : The variation in growth along an altitudinal transect is not accounted for by variation in temperature

To achieve critical tests of these hypotheses, measurements of height extension and needle length were made along an altitudinal transect using two sorts of material: a) native trees b) young trees in pots. The latter were included to ensure a common age, soil and genotype at all stations, and to permit transport of the plants to a lowland garden after two years of exposure on the transect.

An attempt is made to relate growth rates to temperature, and to relate accumulated growth to accumulated temperature above a stated threshold temperature (the so-called heat sum). The air temperature difference between terminal meristems and

temperatures was also examined as it was considered that this difference may depend appreciably on altitude as a result of increasing exposure along the transect.

## **(ii) Materials and methods**

Five 'open' sites for stations were chosen at Creag Fhiaclach (Grid ref: 855053) in the Cairngorm mountains of Scotland ranging from 675 m above the natural tree-line down to 290 m in the valley below (all elevations are given in metres above sea level). A full description of the area and the position of the stations is given in section (iii) of chapter 1. The stations were chosen at intervals with respect to altitude;

station 1	675 m, well above the tree-line
station 2	580 m, immediately above the tree-line
station 3	570 m, immediately below the tree-line
station 4	450 m, a large gap within the main forest
station 5	290 m, at the edge of the valley below.

Two stations were chosen at or near the natural tree-line to give information on any variation in the parameters measured over this important transition zone of relatively short distance.

Two-year-old Scots pine trees of Dunkeld provenance were placed at the five stations in April 1989. Each tree had been potted into a 1.5 dm<sup>3</sup> black polythene pot in early February in a mixture of Irish peat moss, sand and "Enmag". The quantities used in the mixture were those recommended by the Forestry Commission as compost fertiliser for forest tree seedlings and can be found in Appendix I.

Eight potted trees were placed at each station and were sunk into the soil after removing the base of each pot such that the rim of the pot was level with the soil surface. This was done in order to reduce the temperature differences between the pots and the surrounding soil and to prevent the potted soil from drying out. Within each station the trees were placed in an irregular pattern and at least 60 cm

apart from any other in an attempt to simulate natural conditions and to make the trees less conspicuous to deer.

A sixth station was chosen at Edinburgh in the University grounds at King's Buildings (200 m) to form an extension of the altitudinal gradient at Creag Fhiaclach. A further eight plants were placed here; in this case pots were not sunk below the soil surface but were watered as necessary. In addition two stations were set up in separate sections of a heated greenhouse in the University grounds to obtain data on the growth of Scots pine at temperatures above those usually experienced in the British Isles. The second section will be referred to as the "tropical greenhouse" where temperatures were generally between 2 and 4 °C higher than those in the first section, or "first greenhouse". Eight plants were placed on a bench in each greenhouse and watered regularly.

Air temperature sensors were constructed using thermistor beads (151-243, R.S. Components, Corby, Northamptonshire, England) and wired as recommended by Campbell Scientific to 2-core shielded cable. They were calibrated against a mercury-in-glass thermometer by immersion in a vacuum flask at a range of temperatures. They were calibrated three times during use and small changes were made to the calibration factor to compensate for drift. It is considered that the quoted temperatures have a precision of  $\pm 0.2$  °C. Differential copper-constantan thermocouples were also constructed to measure the temperature difference between air and plant (British Standard (BS 1843) Type T thermocouple wire, 42 gauge, 0.1mm, obtained from TC, Uxbridge, Middlesex, England). A 1 m-high wooden post was placed at each station and a thermistor and the negative end of a thermocouple were attached, passing through a hole at the top and protected from solar radiation and rain by a white, plastic radiation shield which allowed air to circulate freely around the sensors. The sensors were held closely together by a piece of insulated wire so that readings of temperature from the thermistor could be used as a reference for the differential thermocouple output. The positive end of each thermocouple was inserted into the terminal meristem of a current year lateral shoot (as described in Wilson *et al.*, 1987) where it was held in place as a result of resin production.

All sensors were connected to a datalogger (CR21, Campbell Scientific Instruments, Sutton Bonington, Leicestershire, England) which was placed close to

the post and programmed to average 10 second readings over 24 hours and to record the daily maximum and minimum temperatures. At the tree-line stations a single datalogger (CR21X, Campbell Scientific Instruments) recorded data from both stations, and at the University a CR21 logger recorded data from both greenhouses and from the station outside, 200 m. Data were downloaded onto tape by means of a computer cassette recorder (CCR-82 Tandy Corporation, Wednesbury, West Midlands, U.K.).

During the growth season of 1989 the field site was visited every three weeks. On the first two occasions the total number of new fascicles was counted on every potted tree. On subsequent visits measurements of height extension and needle length were made on the terminal shoot using a transparent plastic 15 cm ruler. Height extension was measured from the base of the terminal shoot to the tip of the terminal meristem and recorded to the nearest millimetre. The needle lengths of five needles on the terminal shoot were measured from base to tip. Needles from each region of the shoot were measured and the lengths averaged to give one value per plant. In addition, five saplings of native trees (of up to 1 m in height) were chosen at each altitude on which height extension and needle length were measured in the same way. Just below the tree-line some larger trees were chosen (up to 2 m) as insufficient smaller saplings were available. Above the tree-line (580 m and 675 m) these trees were mainly between 15 cm and 30 cm tall.

The plants at the University stations were measured in the same way although no native trees of comparable height were available.

All measurements were repeated at similar intervals during 1990. In April 1991 the equipment was disconnected and returned to the laboratory. In the 1991 growing season all potted plants were brought to a common garden site to test for a residual effect of treatment. All potted plants were lifted from the soil and placed in individual, labelled polythene bags and taken back to the University where they were re-potted into 4 l black polythene pots in a similar compost to before. Care was taken not to disturb the root ball. Having been clearly labelled these plants were placed outside the University adjacent to those of station 6 (200 m). The number of new needle fascicles were counted on each tree and measurements of height extension and needle length were continued throughout the summer. Measurements on the greenhouse plants were continued as before (all plants

remaining in their respective greenhouses) and both air and meristem temperatures were recorded at each of the Edinburgh stations.

All data were initially sorted using a spreadsheet package (Lotus 123, Lotus Development Corporation, Cambridge, Massachusetts, U.S.A.) and then transferred to another (Quattro Pro, Borland International Inc., California, U.S.A.) where graphs were plotted.

Mean daily temperatures from all stations were averaged for each month from May to September for both years and were plotted against altitude. The data from station 6 and the two greenhouses were plotted separately since the environmental conditions there were not directly comparable to those of the field site. This was then repeated for meristem temperatures.

A two-way analysis of variance was carried out separately on each data set (native trees, potted trees from the field site and potted trees at Edinburgh) for height extension, for the number of needle fascicles and for needle length by means of a statistical computer package (Statview 512+, BrainPower Inc., Calabasas, California, U.S.A.).

Mean height extension per station was plotted against time for the first year's measurements. This was then repeated for mean needle length. These plots were made in order to give an idea of the timing and duration of the main growing period for needles and plant height and to determine any differences in those periods between stations.

Having determined the main period of growth for height extension the final mean values were plotted against the corresponding mean monthly meristem temperatures averaged over the relevant months. Graphs were plotted using the 1990 growth data and the current and previous year meristem temperatures. This was carried out for all trees measured.

Three further graphs were plotted using the 1991 growth data of the potted trees which had been brought back to Edinburgh. Plots were made against corresponding previous year (1990) temperatures to determine any "carry-over" effects with time in the relationships.

For each plot against current and previous year temperatures a regression analysis was carried out and the regression line superimposed on the graph. For the potted trees data from station 5 (290 m) were not included in the analysis due to the poor health condition of the plants and in most cases the data from the two greenhouses were also omitted as growth under the conditions experienced there was considered to be beyond the linear part of the normal growth curve as a result of high temperatures. The exceptions to this were the plots of final mean height extension of the potted trees at all stations in 1990. In these cases a second order polynomial curve was fitted (Cricket Software Inc., Philadelphia, U.S.A.) to the data to incorporate the greenhouse stations whilst maintaining the linear part of the growth curve seen at the lower temperatures of the field stations.

For plots against mean meristem temperatures station 1 (675 m) was omitted as no monthly values were available for May and June at this station. Probability values were obtained from statistical tables (White *et al.*, 1979) using the calculated *R* values.

Degree days of mean air temperature over the measurement periods of the three years were calculated using a FORTRAN program 'DEGREE' a copy of which can be found in Appendix II. This program was run several times on each data set using different threshold values (5, 7 and 10 °C). Mean needle length per station was plotted against degree days and the threshold at which the best possible fit was obtained, ie. where plots from different altitudes fell along, or close to a single line, was chosen for plotting the final graphs.

### (iii) Results

#### *Temperature data*

Table 2.1 shows the mean monthly temperature data from the meteorological stations at Aviemore and the Cairngorm Chairlift. The figures in brackets for Aviemore are the difference from the monthly average from 1951 to 1980 and indicate that 1990 was a warmer year than average. The warmest months were July and August for both stations in each year. The mean monthly temperatures at the Cairngorm Chairlift were consistently lower than those of Aviemore throughout the two years shown and the difference between the two was used to calculate the environmental lapse rates. The rates varied from  $-3.2\text{ }^{\circ}\text{C km}^{-1}$  in May, 1990 to  $-6.9\text{ }^{\circ}\text{C km}^{-1}$  in April 1989. In both years the rates of change in temperature were larger in April than in May, July or August. July 1989 was a very warm month.

Environmental lapse rates at Creag Fhiaclach are shown in Table 2.2, calculated by fitting a linear regression to the data from the five stations. They varied from  $-5.5\text{ }^{\circ}\text{C km}^{-1}$  in August 1990 to  $-11.1\text{ }^{\circ}\text{C km}^{-1}$  in May 1990. The rates for 1989 were within this range and were much less variable between months. The environmental lapse rates at this site were notably higher than those between the Aviemore and Cairngorm Chairlift meteorological stations. The mean rate for the months shown was  $-9.4\text{ }^{\circ}\text{C km}^{-1}$  in 1989 and  $-7.7\text{ }^{\circ}\text{C km}^{-1}$  in 1990 compared to an average of  $-5.0\text{ }^{\circ}\text{C km}^{-1}$  in both years between the meteorological stations. However, the distance between the two latter stations is far greater than the upper and lower stations at Creag Fhialach and therefore these altitudinal transects may not be directly comparable in terms of lapse rates.

Figure 2.1 shows the mean monthly air temperatures (May to October) for the five stations measured at Creag Fhiaclach. In 1989 July was the warmest month at each station, ranging from  $13.8\text{ }^{\circ}\text{C}$  (675 m) to  $16.9\text{ }^{\circ}\text{C}$  (290 m). Temperatures were approximately  $4\text{ }^{\circ}\text{C}$  higher than those of the next warmest month, August, in all cases. The coolest month was October during which the mean temperatures ranged from  $6.7\text{ }^{\circ}\text{C}$  at 675 m to  $10.4\text{ }^{\circ}\text{C}$  in the valley. Mean temperatures at each station were very similar for May and September ranging from  $8.2\text{ }^{\circ}\text{C}$  (675 m) to  $11.7\text{ }^{\circ}\text{C}$  (290 m). For all months shown mean temperature decreased with increasing altitude.

**Table 2.1 :** Mean monthly temperatures and environmental lapse rates between Aviemore (229 m) and Cairngorm Chairlift (663 m). The figures in brackets for Aviemore are the differences from the monthly average (1951 to 1980), where negative means the month was colder than average.

---

<b>1989</b> Month	Aviemore	Cairngorm Chairlift	Temperature change over 434 m	Lapse rate (°C km <sup>-1</sup> )
April	4.6 (-1.4)	1.6	3.00	-6.91
May	9.7 (+0.6)	7.4	2.25	-5.18
June	11.6 (-0.7)	9.7	1.90	-4.38
July	15.9 (+2.4)	13.9	2.00	-4.61
August	13.3 (+0.1)	10.7	2.60	-5.99
September	10.5 (-0.4)	9.0	1.55	-3.57
October	8.8 (+0.6)	6.8	1.95	-4.49
<b>1990</b>				
April	6.4 (+0.5)	4.0	2.40	-5.53
May	9.9 (+0.8)	8.5	1.40	-3.23
June	11.4 (-0.8)	8.7	2.75	-6.34
July	14.0 (+0.5)	12.0	1.95	-4.49
August	14.1 (+1.0)	11.8	2.35	-5.41
September	10.2 (-0.7)	7.8	2.40	-5.53
October	8.5 (+0.3)	6.6	1.90	-4.38

**Table 2.2 :** Environmental lapse rates at Creag Fhiaclach between station 5 (290 m) and station 1 (675 m) during 1989 and 1990, °C km<sup>-1</sup>. (Calculated using regression analysis).

---

<b>Month</b>	<b>1989</b>	<b>1990</b>
May	-9.2	-11.1
June	-9.2	-8.3
July	-8.2	-6.1
August	-10.8	-5.5
September	-9.1	-6.8
October	-9.6	-8.2

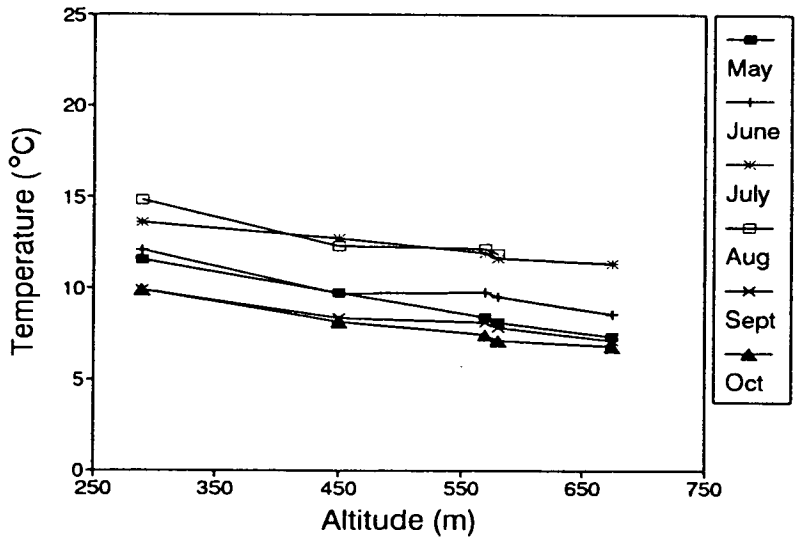
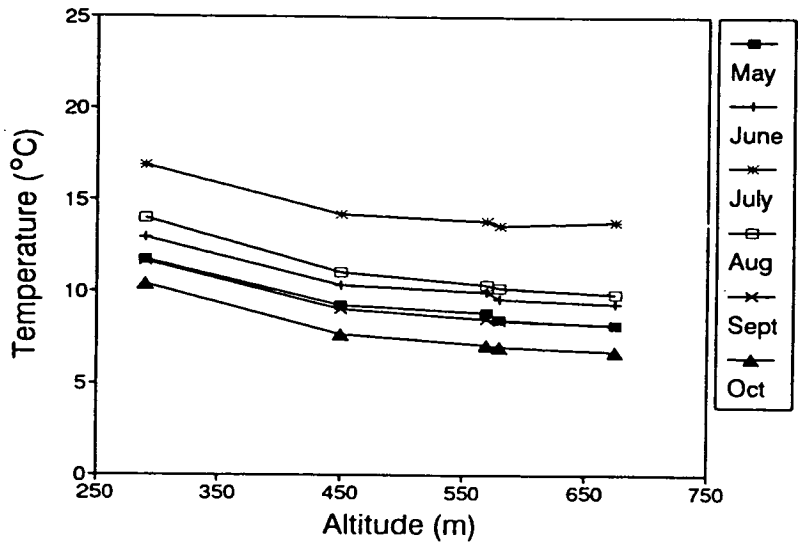

**Figure 2.1:** Mean monthly air temperatures at Creag Fhiaclach; 1989 (upper), 1990 (lower).

In 1990 July and August were the warmest months with temperatures from 11.3 °C (675 m) to 14.8 °C (290 m). May was warmer than September at the three lowest stations and September temperatures were similar to those of October at all altitudes, being between 6.8 °C (675 m) and 9.9 °C (290 m). In general mean temperature decreased with increasing altitude as in 1989, but overall 1990 was a cooler year.

For both years a distinct temperature difference between the two tree-line stations was shown. In each case the higher station (580 m) experienced mean temperatures approximately 0.3 °C lower than those of the station immediately below the tree-line (570 m). However, as the precision of measurement was only 0.2 °C the true difference may have been smaller.

Figure 2.2 shows similar plots for the Edinburgh stations. For each of the three years measured, mean monthly air temperatures were highest in the tropical greenhouse and lowest outside at station 6, as expected. In 1989 July was the warmest month (16.7 °C at station 6 to 24.1 °C in the tropical greenhouse) and May, September and October the coolest (12.1 °C and 21.0 °C, respectively). In 1990 August was the warmest month and May the coolest in the cases of station 6 and the first greenhouse, but in the tropical greenhouse July was the warmest and September the coolest. Unfortunately no data are available for October of that year.

For all three years the mean monthly temperatures at station 6 were slightly higher than those at the lowest station at Creag Fhiaclach (290 m) with a few exceptions in the warmest months. In this way the original idea that the station outside the greenhouses would form an extension to the altitudinal gradient at the field site can be seen to have been realised.

Figure 2.3 shows the mean monthly meristem temperatures of the potted trees at the field site over the two growth seasons. In both years there was a clear decline in temperature with increasing altitude from 290 m to 450 m. In 1989 this decline extended as far as the tree-line with plants above this experiencing meristem temperatures similar to those of station 2 (580 m). The following year the meristem temperatures of the trees either side of the tree-line were comparatively

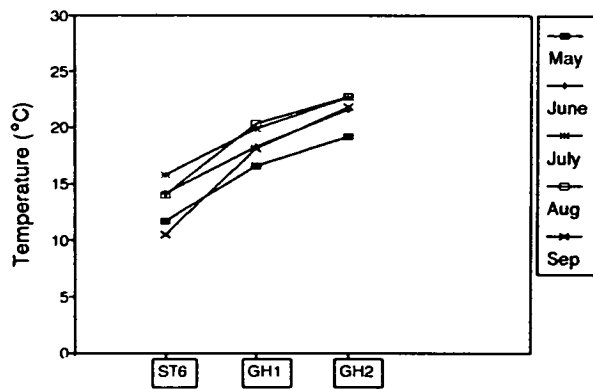
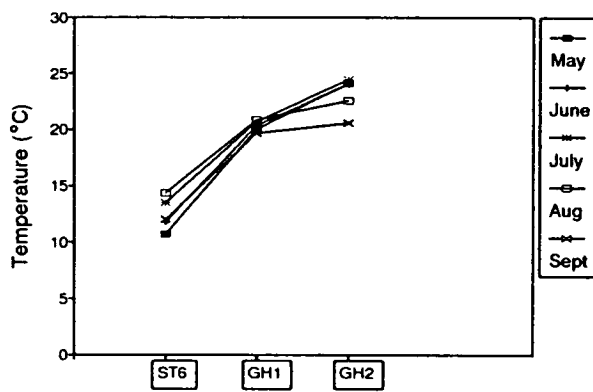
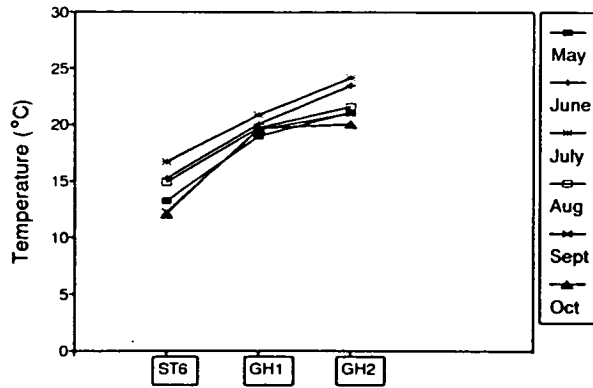

**Figure 2.2:** Mean monthly air temperatures at the three Edinburgh stations; 1989 (upper), 1990 (middle), 1991 (lower).

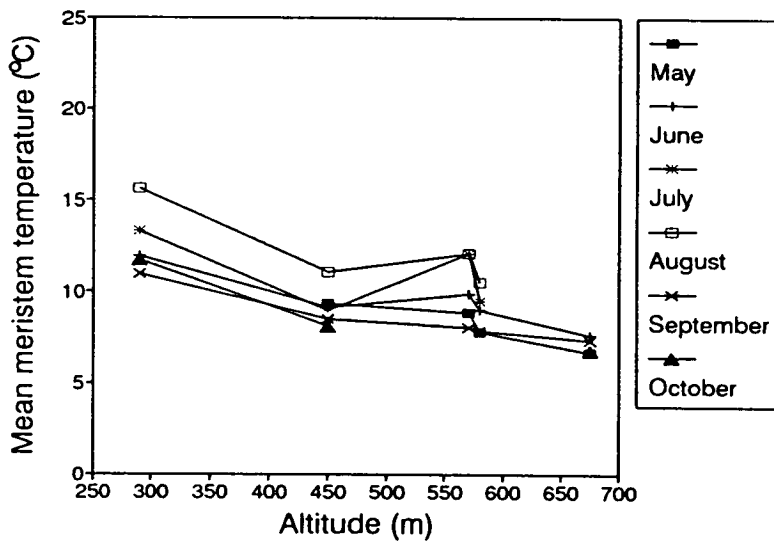
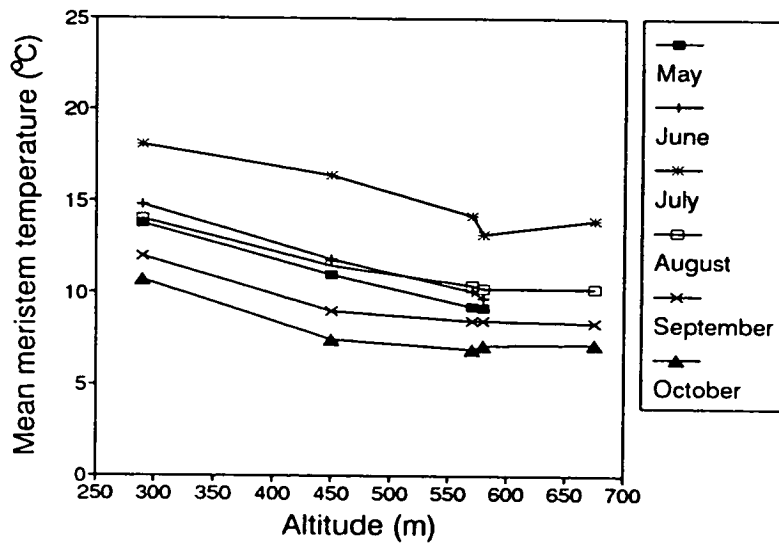

**Figure 2.3:** Mean monthly meristem temperatures at Creag Fhiaclach; 1989 (upper), 1990 (lower).

higher in relation to the trees above and below and thereby a more linear gradient was formed, particularly in the cooler months (May, September and October). In both summers a steep decline in meristem temperatures was observed between the two tree-line stations in the warmest months (July 1989, August 1990).

Comparable data for the three Edinburgh stations are shown in figure 2.4. Meristem temperatures ranged from 8.9 °C at station 6 (September 1991) to 24.0 °C in the tropical greenhouse (July 1990). For every month measured the meristem temperatures were highest in the tropical greenhouse and lowest outside at station 6 and showed a near-linear increase in the warmest months of each year.

Table 2.3 shows the mean monthly meristem temperatures of the potted trees at all stations expressed as the difference from the corresponding air temperatures 1 m above the plants. Overall the mean meristem temperatures were warmer than the mean air temperatures at the field site in 1989 but lower than the air at the Edinburgh stations. The largest differences between the temperature of the plants and the air occurred in May, June and July at the lowest three stations but differences were also high in October above the tree-line. The meristems of the trees at the Edinburgh stations were cooler than the air in June, more so than in any other month.

In the following year it was more frequent that the plants experienced mean monthly temperatures below those of the air, the largest differences occurring in July and August at stations 4 (450 m) and 2 (580 m). The only months where the mean meristem temperatures exceeded those of the air by more than 1 °C were September and October and this only at the lowest station. At the Edinburgh stations the meristems were cooler than the air early in the season but on the whole were warmer than the air in comparison with 1989 at station 6 and in the first greenhouse. In the tropical greenhouse mean meristem temperatures were consistently lower than those of the air.

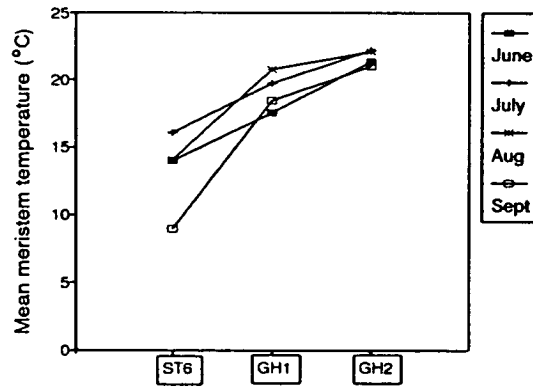
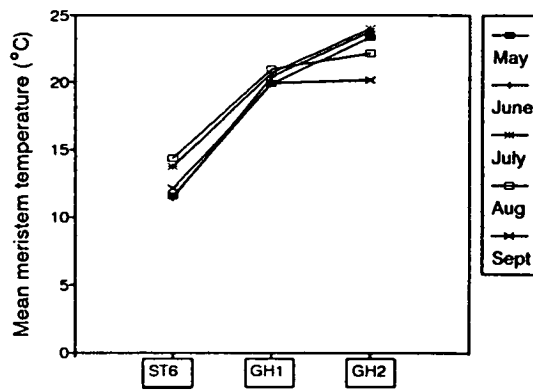
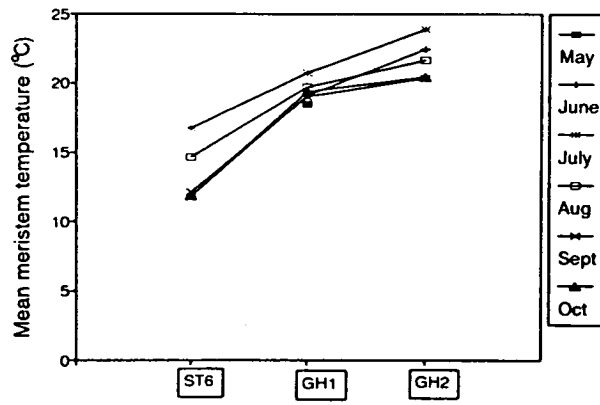

**Figure 2.4:** Mean monthly meristem temperatures at the three Edinburgh stations; 1989 (upper), 1990 (middle), 1991 (lower).

**Table 2.3 :** Mean monthly meristem temperatures as differences from mean monthly air temperatures, ( $^{\circ}\text{C}$ ). (Edinburgh stations: ST6 - station 6; GH1 - first greenhouse; GH2 - tropical greenhouse).

---

<b>1989</b>						
<b>Altitude (m)</b>	<b>May</b>	<b>June</b>	<b>July</b>	<b>Aug</b>	<b>Sept</b>	<b>Oct</b>
290	2.04	1.82	1.19	0.02	0.33	0.30
450	1.72	1.48	2.15	0.46	-0.05	-0.23
570	0.42	0.13	0.36	0.04	-0.05	-0.21
580	0.70	0.10	-0.39	0.08	0.07	0.13
675			0.11	0.35	0.17	0.48
<b>Station</b>						
ST6		-3.41	0.06	-0.25	-0.10	-0.23
GH1	-0.49	-0.93	-0.09	-0.01	-0.47	-0.29
GH2		-1.05	-0.22	0.06	-0.70	0.37
<b>1990</b>						
<b>Altitude (m)</b>	<b>May</b>	<b>June</b>	<b>July</b>	<b>Aug</b>	<b>Sept</b>	<b>Oct</b>
290		-0.14	-0.30	0.80	1.05	1.80
450	-0.38	-0.58	-3.77	-1.24	0.15	-0.04
570	0.45	0.10	0.14	-0.10	-0.03	
580	-0.30	-0.50	-2.17	-1.37	0.05	
675	-0.68	-0.96			-0.46	-0.03
<b>Station</b>						
ST6	0.90	-0.33	0.24	0.02	0.10	
GH1	-0.09	0.13	-0.02	0.13	0.33	
GH2	-0.75	-0.26	-0.41	-0.41	-0.36	
<b>1991</b>						
<b>Station</b>	<b>June</b>	<b>July</b>	<b>Aug</b>	<b>Sept</b>		
ST6	-0.13	0.32	0.09	-1.52		
GH1	-0.69	-0.14	0.45	0.36		
GH2	-0.24	-0.49	-0.62	-0.81		

## *Height growth*

Figure 2.5 shows the mean total height extension achieved by September for all sites. The bar charts can be viewed separately in terms of native and potted trees and altogether on a yearly basis. The native trees showed a very clear decline in height extension with increasing altitude in both years. The potted trees at the field site, however, showed a decline only from 570 m in 1989 and from 450 m in 1990, the trees at 290 m having lower values in each case. These trees at station 5 (290 m) showed symptoms of damage by the middle of the 1989 growth season and by early October six out of eight appeared either mostly or completely brown. Although seven plants survived until the end of the 1991 growth season the poor condition of the trees at this station was such that when the results were plotted the growth trend with altitude was not as linear as it might otherwise have been. For this reason the growth data from this station have not been included in the figures in this chapter other than those of raw data (figures 2.5 to 2.9).

The native trees attained similar heights at each altitude in both years whereas the potted trees grew far more in 1989 than in subsequent years, in some cases twice as much.

The data for the native trees show clearer trends than the potted ones. The 'noise' in the data from potted trees may reflect aspects of establishment, as the root system reached the underlying soil.

After an analysis of variance had been carried out on these data it was seen that the decrease in height extension with increasing altitude was significant at the 0.1 % level ( $P=0.001$ ) for the native trees and at the 5 % level ( $P=0.05$ ) for the potted trees. The relationship with year was highly significant ( $P=0.001$ ) in the case of the potted trees as was expected from the large differences in growth observed between years. but was not significant for the native trees even at the 10 % level ( $P=0.1$ ), the trees having grown approximately equal amounts in both years of measurement.

The potted trees at the Edinburgh stations all grew approximately 140 mm in the first year which was similar to those at Creag Fhiaclach but exceeded the native

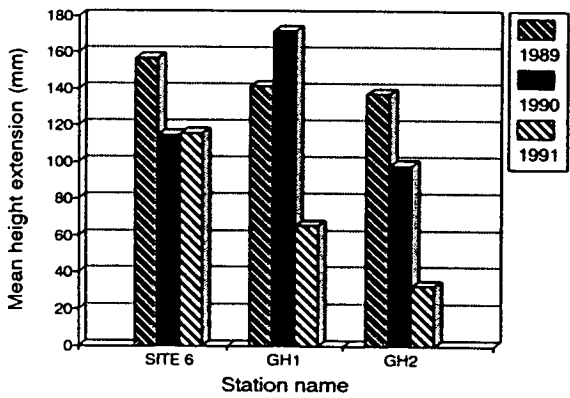
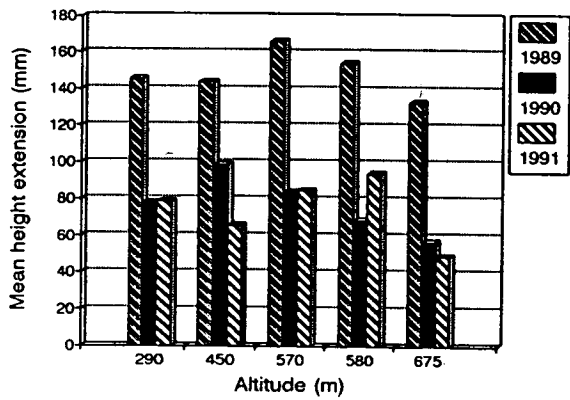
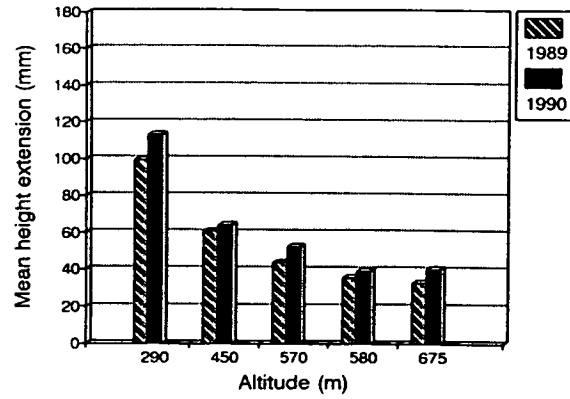

**Figure 2.5:** Mean total height extension for native (upper) and potted (middle) *P. sylvestris* at Creag Fhiaclach, and for potted trees at the Edinburgh stations (lower). Variation between altitudes/stations significant at  $P=0.001$  (native and Edinburgh),  $P=0.05$  (potted).

trees there which only reached 100 mm (290 m). In the second year distinct differences were seen between the stations with those trees in the first greenhouse reaching heights more than 50 mm greater than those of the other two stations. The pattern changed once again in 1991 when a stepwise decline in mean total height extension occurred from 115 mm at site 6 to 30 mm in the tropical greenhouse.

Analysis of variance showed the relationships of height extension with station and with year to be significant at the 0.1 % level ( $P=0.001$ ). In both cases the relationships mainly involved decreases in height extension. The interaction of altitude or station with time on height extension was also highly significant at the Edinburgh stations but was not significant for any of the trees at the field site.

### *Number of fascicles*

Figure 2.6 shows the mean number of needle fascicles per station produced at the beginning of each growth season on the leading shoots of all plants measured. By comparing the three graphs it can be seen that fewer fascicles were produced by the native trees than the potted ones and that the highest numbers were produced at the Edinburgh stations, notably station 6. The mean numbers of fascicles produced in 1989 were greater than those in 1990 at all stations except for the native trees at station 5 at Creag Fhiaclach and the potted trees at station 6 at Edinburgh. The relationship of fascicle numbers with time was highly significant ( $P=0.001$ ) for all potted trees but was not significant for native trees even at the 10 % level.

A decrease in fascicle numbers with increasing altitude was shown by the native trees and, above 290 m, also by the potted trees in the two years at the field site (figure 2.6). The relationship between fascicle numbers and altitude was significant at the 1 % level ( $P=0.01$ ) for both groups of trees. In 1991, after the potted trees had been returned to Edinburgh, the pre-programming effect from the previous summer was not apparent in the numbers of new fascicles produced as there was no clear trend with altitude as might have been expected. However, a large drop in numbers between these two years did occur in plants from all stations implying that cooler temperatures were experienced in 1990 than in 1989. This is in agreement with the temperature data (figure 2.3 and table 2.3).

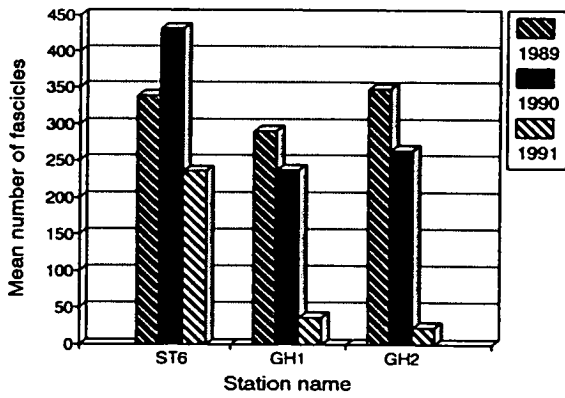
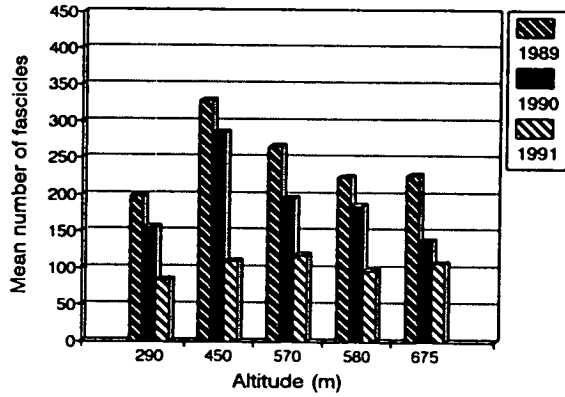
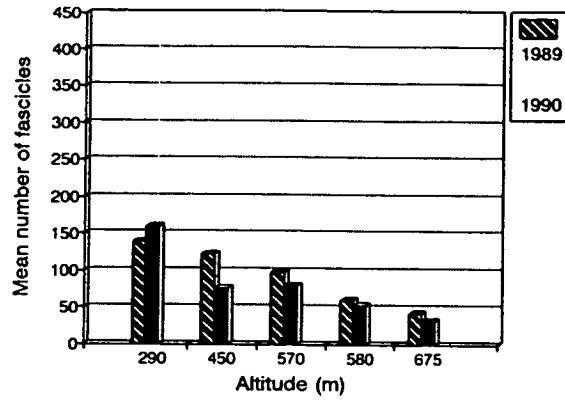

**Figure 2.6:** Mean total number of needle fascicles for native (upper) and potted (middle) *P. sylvestris* at Creag Fhiaclach, and for potted trees at the Edinburgh stations (lower). Variation between altitudes/stations significant at  $P=0.001$  (Edinburgh,  $P=0.01$  (native and potted)).

At the Edinburgh stations more fascicles were produced on the trees growing outside than on those in the greenhouses in each year of measurement. The relationship between stations and number of fascicles was highly significant ( $P=0.001$ ). The interaction of station or altitude with time on fascicle numbers was not significant for either groups of trees at Creag Fhiaclach and was significant only at the 5 % level ( $P=0.05$ ) for the potted trees at the Edinburgh stations.

### *Needle lengths*

Mean total needle lengths are shown in figure 2.7. As for height extension the native trees have both the lowest overall values and the least variation between years. All needles were less than 35 mm in length and the largest difference between 1989 and 1990 was 6 mm (675 m). The relationship between needle length and year was found to be significant at the 1 % level ( $P=0.01$ ) after an analysis of variance. A general trend of decreasing needle length with increasing altitude can be seen although the relationship is not strictly linear due to a slight increase in values at altitudes 570 m and 675 m. This relationship was also significant at the 1 % level.

The same trend is shown in the results of the potted trees for 1989 and 1991 but was not true for 1990. Needle length varied significantly between years (at the 0.1 % level of significance) but was only significant with altitude at the 10 % level ( $P=0.1$ ). The total needle lengths were similar to those of the native trees in 1990 but exceeded them in 1989. The longest needles produced were those which grew in 1991 after the trees had been returned to the University.

The needles of the trees at the Edinburgh stations were longer than all of those at the field site in 1989 and 1990 reaching just over 100 mm in the first greenhouse in 1989. Needle lengths were much smaller at each station in the second year and showed a further decrease the following year in both greenhouses. After an analysis of variance the variation between needle length and time was found to be highly significant ( $P=0.001$ ) as was that between stations. The interaction between time and altitude/station on needle length was significant at the 5 % level

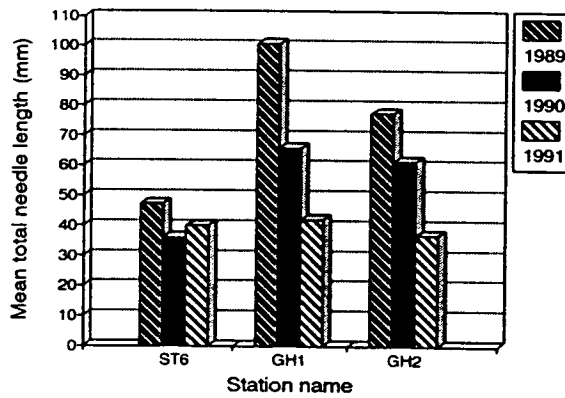
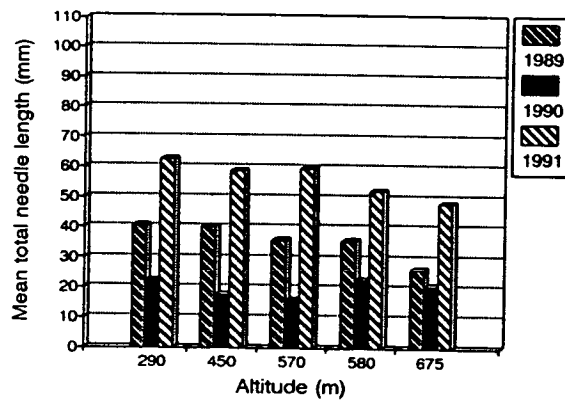
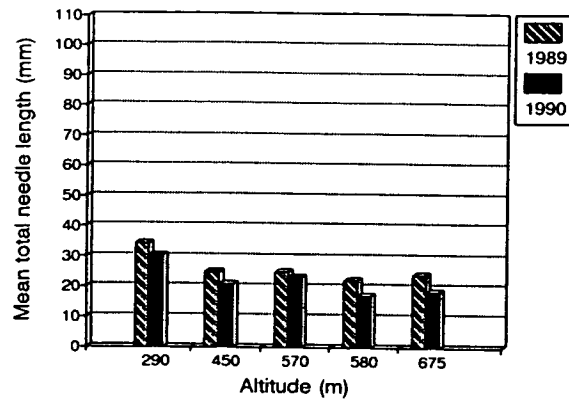

**Figure 2.7:** Mean total needle length for native (upper) and potted (middle) *P. sylvestris* at Creag Fhiaclach, and for potted trees at the Edinburgh stations (lower). Variation between altitudes/stations significant at  $P=0.001$  (native and Edinburgh), not significant for potted.

( $P=0.05$ ) for the Edinburgh stations but was not significant for the trees at the field site even at the 10 % level.

### *Rates of growth*

The relationship between mean height extension and time in 1989 is shown in figure 2.8. The native trees showed a clear trend with altitude, the trees at the highest station having least extension growth and those at the lowest, the most. Distinct groupings were apparent with respect to altitude.

Although least extension took place at the highest station, the trend with altitude was not so clearly defined in the potted trees. The greatest mean height extension occurred just below the tree-line (570 m) and plants just above the tree-line achieved greater heights than those at 450 m and 290 m. However, the heights reached by all potted trees exceeded those of any native trees measured in this year.

The potted plants at the Edinburgh stations attained heights within a similar range to those at Creag Fhiaclach (130 to 170 mm). The plants inside the greenhouses grew approximately equal amounts (140 mm) but those outside had the greatest extension, reaching almost 160 mm.

The time at which the total mean height extension was reached varied between stations and can be used as an indicator of the main growth period of the plants concerned. At the field site the native trees had completed extension growth by the beginning of July (Julian day 182) and at the lowest station by mid-June (J.d. 170). The potted trees, however, only reached full height before July at station 4 (450 m), and most plants completed extension by mid-July (J.d. 200). Those at the highest station continued growth until mid-August (J.d. 230). At Edinburgh the trees in the greenhouses reached full height extension by early June (J.d. 158) whereas those outside did not complete growth until the beginning of July.

Comparable plots for mean needle length are shown in figure 2.9. Less difference was shown between altitudes for either native or potted trees at Creag Fhiaclach than was seen for height extension in this year. Mean needle length of native trees

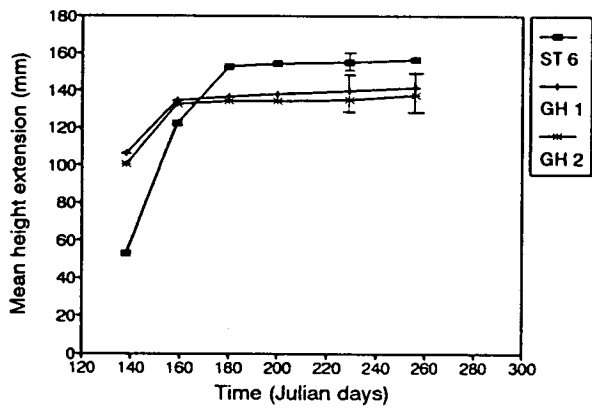
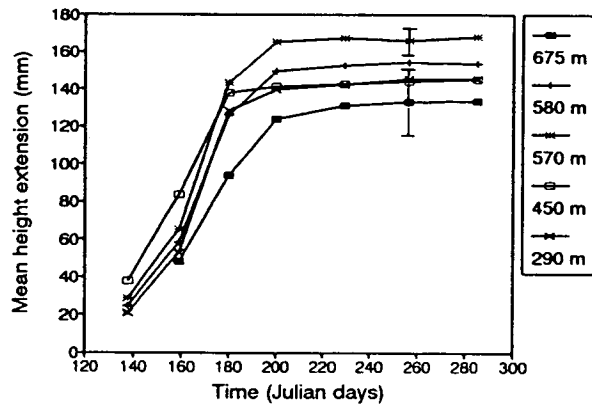
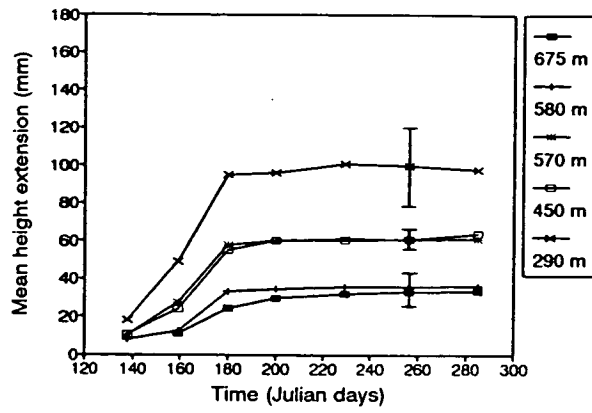

**Figure 2.8:** Relationship between mean height extension and time in 1989 for native (upper) and potted (middle) *P. sylvestris* at Creag Fhiaclach, and for potted trees at the Edinburgh stations (lower). Error bars shown are standard errors.

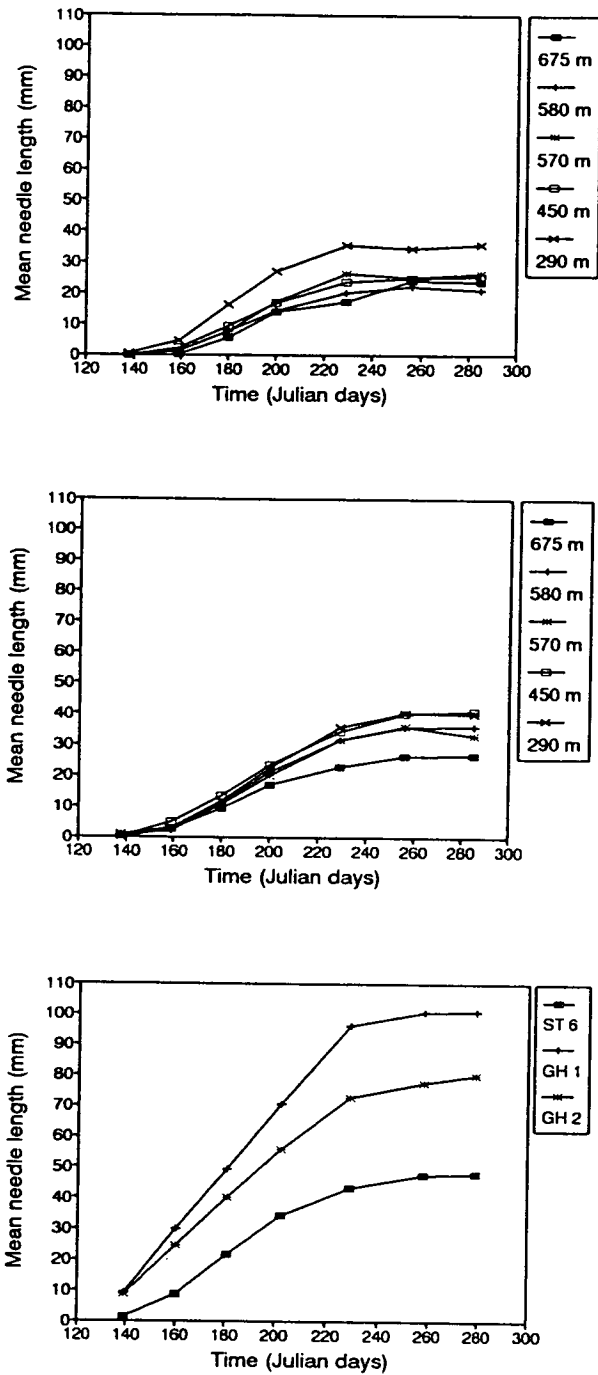

**Figure 2.9:** Relationship between mean needle length and time in 1989 for native (upper) and potted (middle) *P. sylvestris* at Creag Fhiaclach, and for potted trees at the Edinburgh stations (lower).

reached between 20 and 25 mm at all stations except at the lowest (290 m) where it was consistently greater than the rest throughout the measurement period and where it finally reached 37 mm. The results for the potted trees showed an altitudinal trend where mean needle length was smallest at the highest station. The difference between the total mean lengths was 15 mm between the highest and lowest altitudes measured.

Far greater differences occurred between the Edinburgh stations with as much as 30 mm separating the mean total needle length of the trees outside from those of the tropical greenhouse and another 20 mm between the two greenhouse stations.

Perhaps the most obvious difference between these results and those of height extension is the greater length of the growing period in the case of needles. Mean needle lengths of the native trees continued to increase up until mid-August (J.d. 230) at stations 5 (290 m) and 3 (570 m) and until mid-September (J.d. 255) at the other altitudes measured. Needle extension of potted trees at the field site continued until mid-September (J.d. 260) at all stations. At Edinburgh total needle lengths were achieved by mid-September (J.d. 260) in the first greenhouse and at station 6 outside but growth continued until early October in the tropical greenhouse.

Overall mean needle length increased more gradually than height extension, the needle extension period of all plants lasting approximately four months as compared to between two and two and a half months in which height extension was completed.

### *Maximum growth rates and temperature*

Tables 2.4 to 2.6 show the maximum growth rates in mm week<sup>-1</sup> for all native and potted trees at the field site and for potted trees at the Edinburgh stations, respectively. The rates were calculated by dividing the maximum increase within a season by the time period in days over which this occurred. The values were then multiplied by seven to obtain weekly rates.

**Table 2.4:** Maximum rates of growth of native *P. sylvestris* at Creag Fhiaclach over the measurement period, (mm week<sup>-1</sup>).

---

**Rate of increase in height**

<b>Altitude(m)</b>	<b>1989</b>	<b>1990</b>
290	4.83	5.37
450	2.98	3.55
570	2.00	2.54
580	1.65	2.14
675	1.60	2.25

**Rate of increase in needle length**

<b>Altitude(m)</b>	<b>1989</b>	<b>1990</b>
290	2.01	2.05
450	1.48	1.67
570	1.48	1.80
580	1.32	1.20
675	1.73	1.32

**Table 2.5 :** Maximum rates of growth of potted *P. sylvestris* at Creag Fhiaclach over the measurement period, (mm week<sup>-1</sup>). Values for 1991 refer to growth after the plants were returned to Edinburgh.

---

**Rates of increase in height extension**

Altitude (m)	1989	1990	1991
290	25.1	9.9	9.7
450	18.0	15.8	5.7
570	26.1	8.6	10.3
580	22.5	8.9	11.4
675	15.2	7.5	5.5

**Rates of increase in needle length**

Altitude (m)	1989	1990	1991
290	3.3	1.8	5.6
450	3.0	1.3	5.7
570	2.9	1.3	6.2
580	3.0	1.8	5.0
675	2.5	1.6	5.0

**Table 2.6 :** Maximum rates of growth of potted *P.sylvestris* at the greenhouse stations over the measurement period, (mm week<sup>-1</sup>).

---

**Rate of increase in height extension**

<b>Station</b>	<b>1989</b>	<b>1990</b>	<b>1991</b>
6	7.87	6.48	4.64
First GH	2.59	4.28	2.25
Tropical GH	2.92	4.55	2.17

**Rate of increase in needle length**

<b>Station</b>	<b>1989</b>	<b>1990</b>	<b>1991</b>
6	3.21	2.05	2.63
First GH	6.46	2.67	1.54
Tropical GH	4.69	2.81	2.38

Height extension rates of the native trees (Table 2.4) were greater in 1990 than 1989 at all altitudes. Needle extension rates were also higher in 1990 below the tree-line but were higher in 1989 above it. Rates of both height and needle extension decreased with increasing altitude in both years. In both cases the trends were interrupted above the tree-line as higher rates were recorded for the trees at 675 m than those at 580 m. All rates were notably higher at the lowest altitude than at any other station.

Table 2.5 shows the corresponding growth rates for the potted trees at Creag Fhiaclach with the addition of the 1991 results after the trees had been returned to the University grounds. For these trees height growth rates were clearly highest in 1989 and fell by up to 17.5 mm week<sup>-1</sup> (570 m) the following year. The relationship with altitude was less clear but the trees of station 1 (675 m) had the lowest rates each year. Rates of needle extension were lower in 1990 than 1989 but were highest in 1991. The relationship with altitude was not linear.

Results for the trees at the three Edinburgh stations (Table 2.6) show a more complex pattern. In both greenhouses height extension rate increased from 1989 to 1990 and then fell to less than half that of the initial year in 1991. Needle extension rates decreased each year for trees in both greenhouses. Growth rates outside the greenhouses (station 6) were lower in 1990 than 1989. The following year (1991) height extension rate decreased further while that of needle length showed a slight increase.

### *Relationships with temperature*

Figures 2.10 to 2.15 show the plots of growth against current and previous year temperatures. Lines of linear regression (calculated using the mean values from each station) are shown on all graphs except those of figure 2.11 where second order polynomials have been fitted. As no meristem values were recorded for the trees at 675 m at Creag Fhiaclach in May or June of 1989 this site has been omitted from some graphs and in these cases only four (field) points are shown. In each case the slope of the line gives an indication of the rate of change with temperature and the intercept on the x axis approximates to the threshold value above which growth can take place. The native trees at Creag Fhiaclach showed

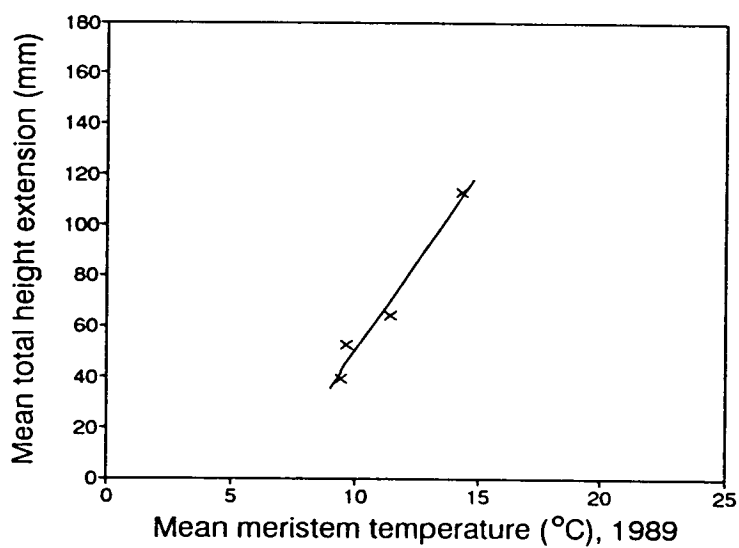
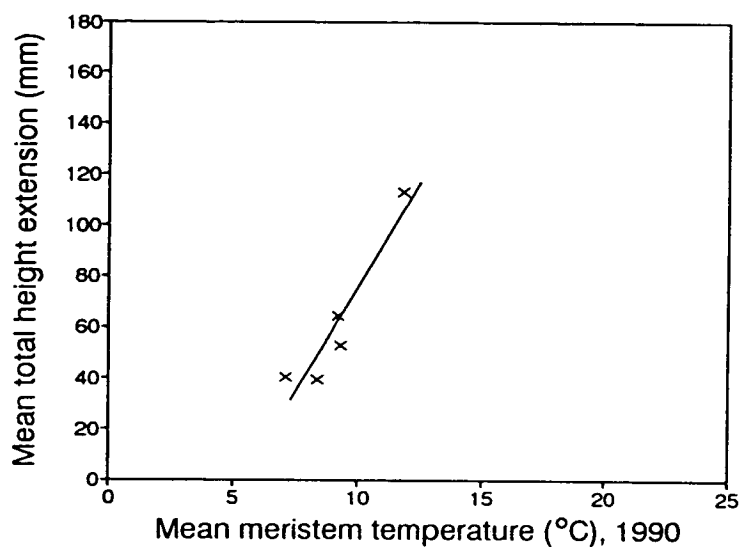

**Figure 2.10:** Relationship between mean total height extension of native *P. sylvestris* at Creag Fhiaclach and mean meristem temperature of the current (upper) and previous (lower) growth season. *R* values are 0.94 and 0.98, respectively.

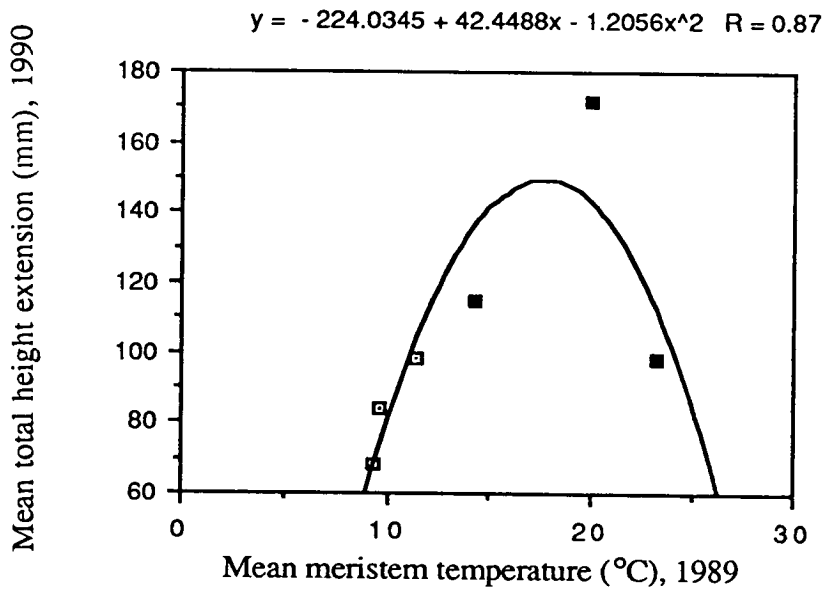
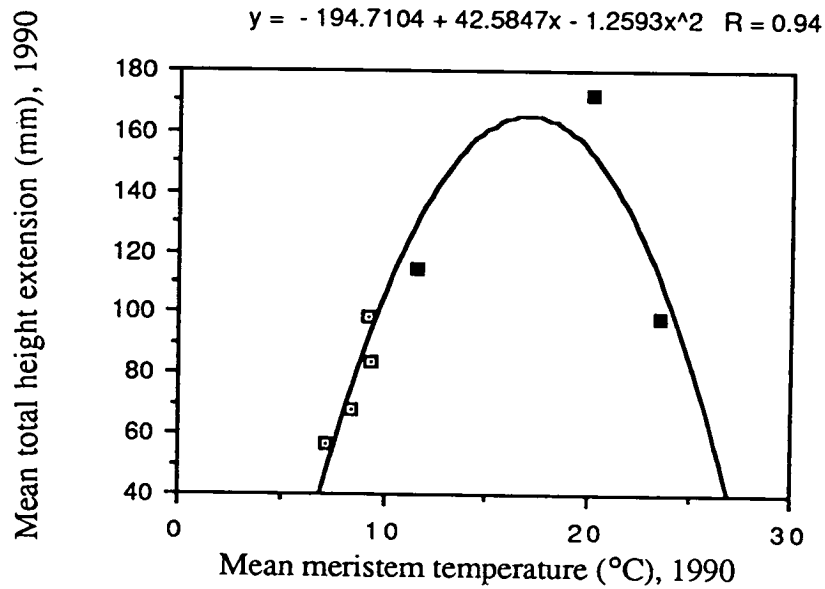

**Figure 2.11:** Relationship between mean total height extension of potted *P. sylvestris* at all stations and mean meristem temperature of the current (upper) and previous (lower) growth season. Filled squares represent Edinburgh stations.

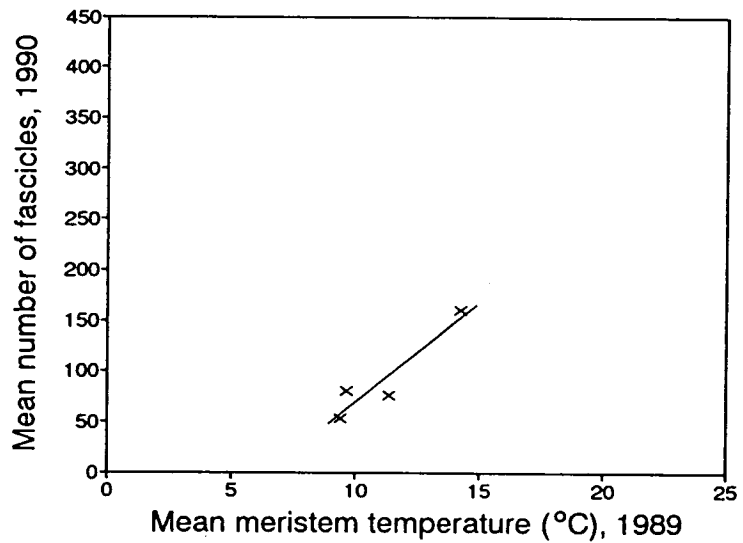
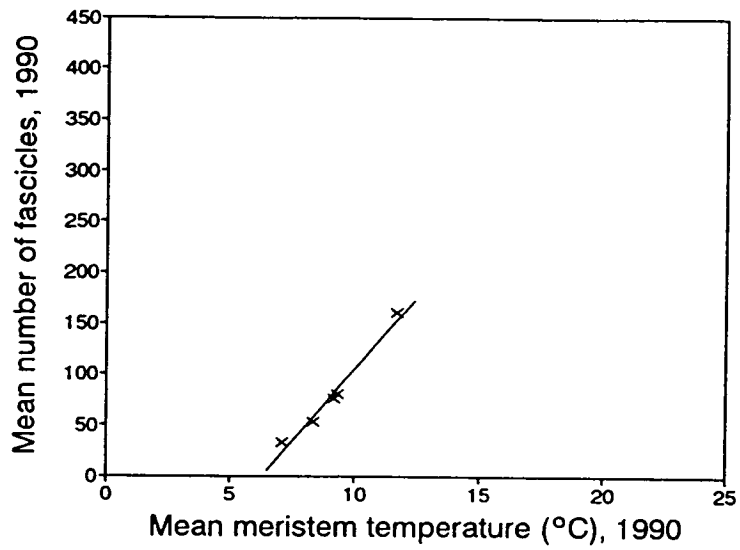

**Figure 2.12:** Relationship between mean total number of needle fascicles of native *P. sylvestris* at Creag Fhiaclach and mean meristem temperature of the current (upper) and previous (lower) growth season.  $R$  values are 0.99 and 0.94, respectively.

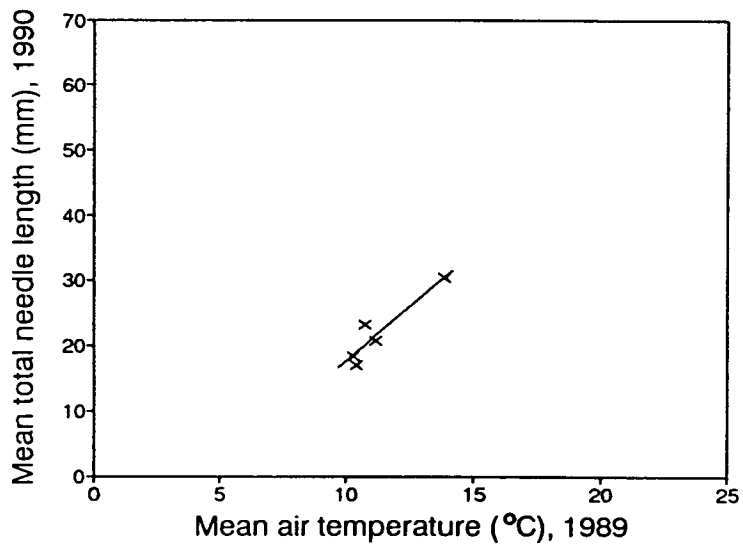
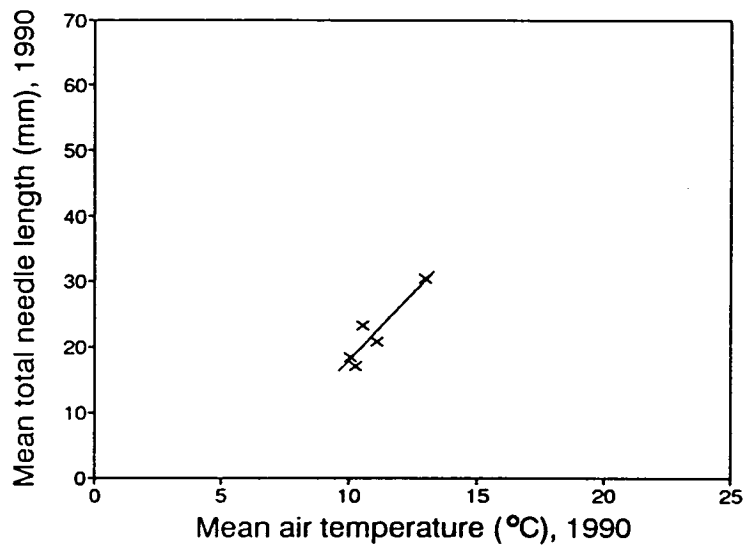

**Figure 2.13:** Relationship between mean total needle length of native *P. sylvestris* at Creag Fhiaclach and mean air temperature of the current (upper) and previous (lower) growth season. *R* values are both 0.93.

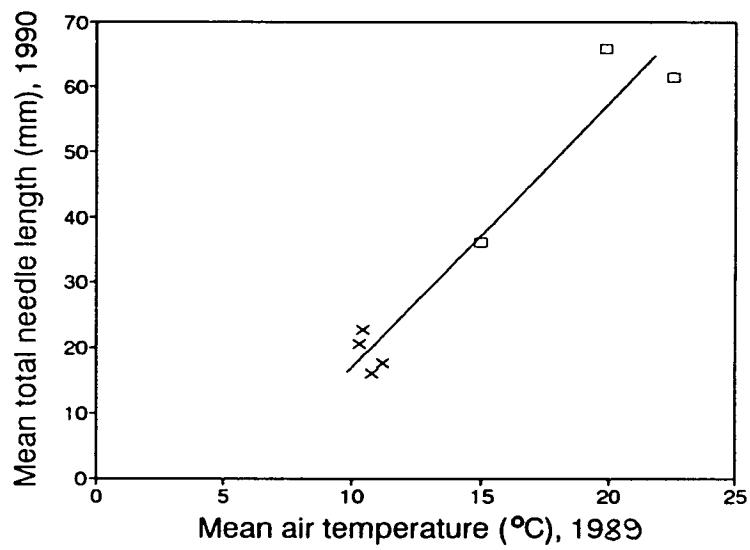
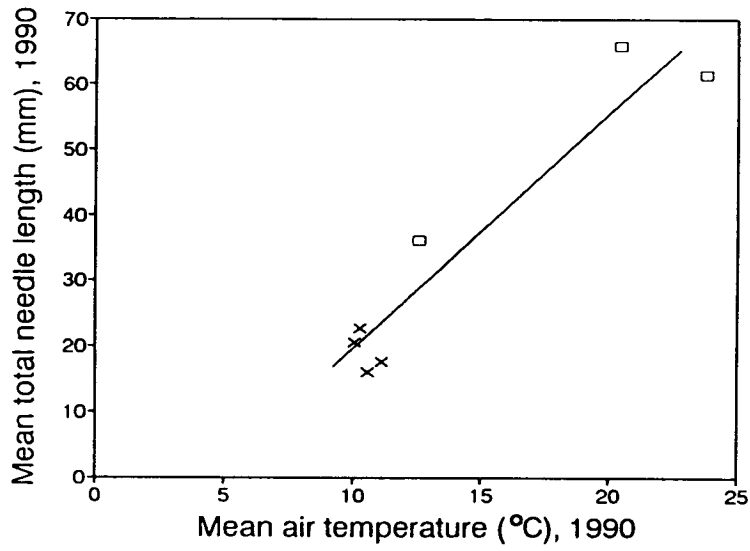

**Figure 2.14:** Relationship between mean total needle length of potted *P. sylvestris* at all stations and mean air temperature of the current (upper) and previous (lower) growth season. Empty squares represent Edinburgh stations. *R* values are 0.95 and 0.97, respectively.

positive correlations ( $P=0.02$ ) between mean total height extension and mean meristem temperatures of both the current and previous growth season (figure 2.10). However, because of correlations between temperatures in 1990 and 1989, these plots cannot be decisive in determining whether 1990 or 1989 temperatures are causally related to extension growth. The threshold value was  $5.4\text{ }^{\circ}\text{C}$  for the current year meristem temperatures and  $6.4\text{ }^{\circ}\text{C}$  for those of the previous year. The gradient of the slope was  $16.4$  and  $14.1\text{ mm }^{\circ}\text{C}^{-1}$ , respectively.

Figure 2.11 shows the same data for the potted trees at all stations. The fitted polynomials give an indication of the temperature optimum of these plants at the uppermost point of the curve where  $dy/dx=0$ . For the plot against current year meristem temperature the apparent optimum was  $16.9\text{ }^{\circ}\text{C}$  and for previous year,  $17.5\text{ }^{\circ}\text{C}$ . The points of intercept on the  $x$  axis (where  $y = 0$ ) are  $5.5$  and  $28.4\text{ }^{\circ}\text{C}$  for the upper graph and  $6.5$  and  $28.6\text{ }^{\circ}\text{C}$  for the lower. The gradient at  $10\text{ }^{\circ}\text{C}$  gives an indication of the sensitivity with temperature. For height extension with current year temperatures this was  $17.4\text{ mm }^{\circ}\text{C}^{-1}$  and with previous year temperature  $18.2\text{ mm }^{\circ}\text{C}^{-1}$ .

The relationship between mean total number of needle fascicles and mean meristem temperatures for the native trees is shown in figure 2.12. The mean number of fascicles was more strongly correlated with the meristem temperatures of the current ( $P=0.01$ ) than the previous ( $P=0.1$ ) growth season.

Mean total needle length of the native trees was positively correlated ( $P=0.05$ ) equally with the air temperatures of the current growth season and those of the previous one (figure 2.13). Air temperature rather than meristem temperatures were used because needles were thought more likely to have experienced temperatures closer to those of the surrounding air, due to their exposed outer position on the plants and their small needle diameter, than to those of the comparatively sheltered meristems.

Comparable plots for the potted trees are shown in figure 2.14. Here the correlation with the previous year's mean air temperatures ( $P=0.001$ ) was greater than that with the current year's ( $P=0.01$ ) with a higher threshold ( $5.8\text{ }^{\circ}\text{C}$  compared to  $4.5\text{ }^{\circ}\text{C}$ ) and rate of increase ( $4.0\text{ mm }^{\circ}\text{C}^{-1}$  compared to  $3.6\text{ mm }^{\circ}\text{C}^{-1}$ ).

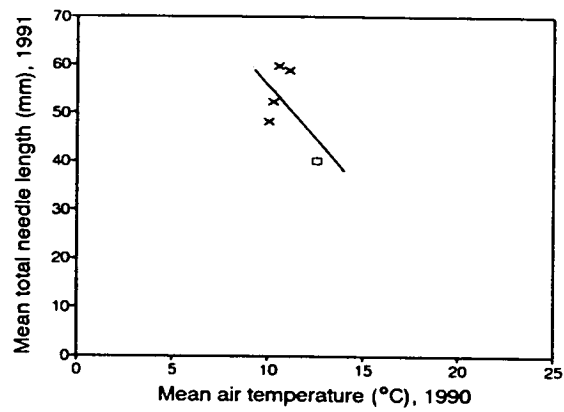
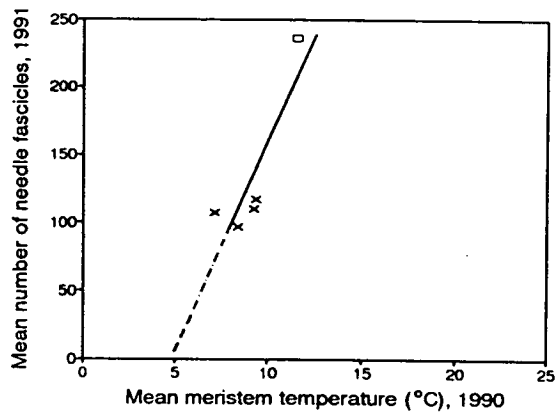
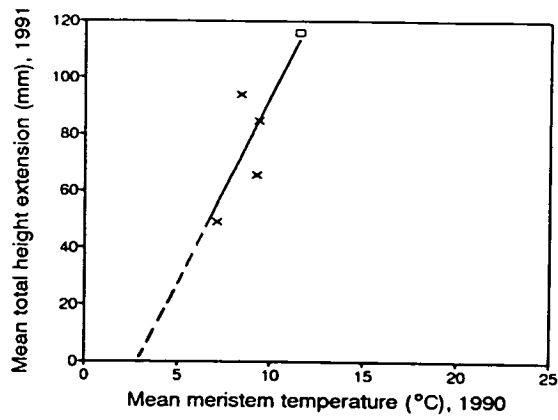

**Figure 2.15:** Relationships between mean total height extension (upper), mean number of fascicles (middle), final mean needle length (lower) and the corresponding temperatures of the previous growth season for potted *P. sylvestris* from all stations (excluding 290 m). Empty squares represent station 6, Edinburgh.  $R$  values are 0.83, 0.86 and 0.55, respectively.

In figure 2.15 the "carry-over" effect of mean air temperatures of the previous season is shown. Plots show growth of the potted trees which had been brought back from the field site now growing together under the same conditions at Edinburgh. Final mean height extension was positively correlated with mean meristem temperatures of the previous year ( $P=0.1$ ) and had a threshold value of between 3 and 4 °C.

The mean number of needle fascicles also showed a positive correlation with mean meristem temperature ( $P=0.1$ ). In this case the threshold was 4.8 °C.

Final mean needle length showed no positive correlation with the mean air temperatures of the previous year implying that those of the current year might be a more important factor determining needle length, as was expected.

### *Needle survival*

Percentage needle survival of current year needles for all potted trees is shown in figure 2.16 (needle survival of native trees is included in chapter 5). At Creag Fhiaclach more than 65% of needles survived both winters at the lower three sites whereas survival was lowest at 675 m being less than 52% each year. At the tree-line survival was high for both sites (>78%) from 1989 to 1990 but the following year was much lower at 580 m (<43%) than at 570 m where it remained high (84%). The relationship with altitude was found to be statistically significant after a two-way analysis of variance ( $P=0.01$ ).

At the Edinburgh stations needle survival was higher from 1990 to 1991 than from 1989 to 1990 in all cases. Percentage survival was greater outside than in the first greenhouse after the first winter but the situation was reversed by the end of the second winter. The most distinct difference between the plants was that needle survival of those grown outside was fairly constant for both years whereas that of the greenhouse trees had doubled from the first year to the second. This variation between stations was found to be statistically significant ( $P=0.02$ ).

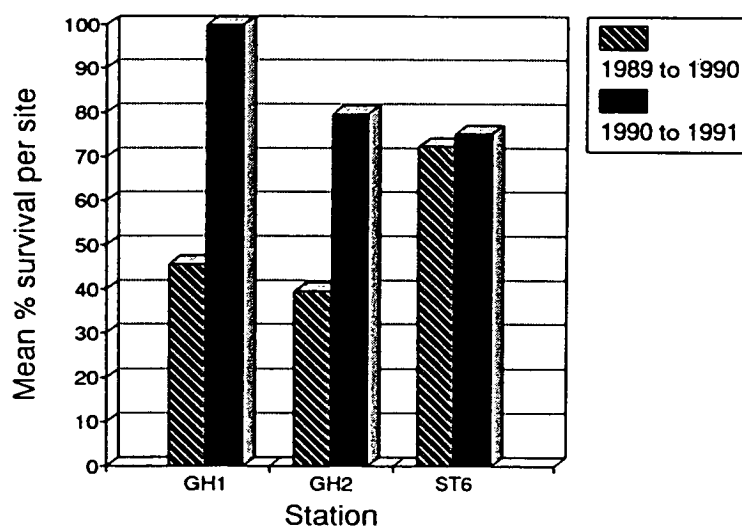
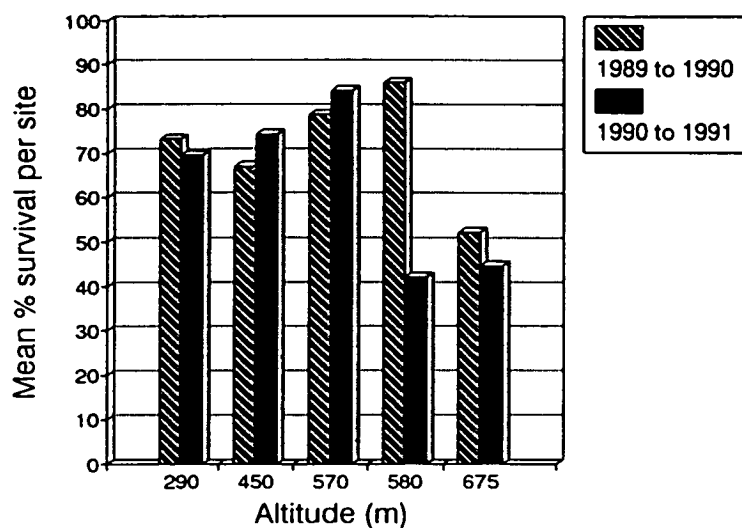

**Figure 2.16:** Mean percentage needle survival of potted *P. sylvestris* at Creag Fhiaclach (upper) and at the Edinburgh stations (lower) for two consecutive years. Variation between stations was significant at  $P=0.01$  (Creag Fhiaclach) and  $P=0.02$  (Edinburgh).

### *Accumulated growth and temperature sum*

The number of degree days accumulated at each station on completion of needle extension for the three years of measurement are shown in table 2.7. Degree days were calculated by accumulating the mean daily air temperatures above a given threshold. Values decreased with increasing altitude, as expected, and with increasing threshold level due to the way in which they were calculated. Far more degree days were accumulated in 1989 than in 1990 at all outside stations (in many cases almost double the number) indicating that 1989 was the warmer year. However, this was not true of the greenhouse stations where an increase between the two years was observed. In 1991 an increase from the previous year occurred, being large at station 6 and smaller in the greenhouses.

Figures 2.17 to 2.19 shows the results of mean needle length plotted against degree days. In most cases the plots for all stations came together when a threshold of 10 °C was used to calculate degree days. For the results of potted trees in 1990 at the field site thresholds of 5 and 7 °C produced closer fits.

Figure 2.17 shows the results for native trees at Creag Fhiaclach. In 1989 mean needle length increased linearly with degree days of temperature sum approximately equally at all five altitudes. The mean needle length at the lowest station (290 m) exceeded that at the others by 9.42 mm. A greater temperature sum accumulated at this altitude beyond that at the other stations which did not exceed 264 degree days. In 1990 fewer degree days were accumulated at each station and final mean needle lengths were shorter. Slopes differed more greatly between altitudes in this year.

Similar plots for the potted trees including data for 1991 are shown in figure 2.18. In 1989 the results of all stations were close although station 5 (290 m) was lower. Here the mean needle length remained below that at higher altitudes for equal numbers of degree days. However, despite a slower rate of increase plants at this altitude had the greatest final needle length and experienced over 300 degree days more than any trees at other stations. At the highest altitude the shortest needle

**Table 2.7 :** Number of degree days accumulated at each station on completion of needle extension in 1989, 1990, and for the Edinburgh stations 1991. Values calculated using three different threshold levels are shown.

---

Altitude (m) or station	Threshold level		
	10 °C	7 °C	5 °C
<b>1989</b>			
290	497.5	818.6	1043.1
450	255.8	520.7	738.5
570	227.8	476.1	688.5
580	210.9	448.4	658.4
675	204.5	430.7	630.8
ST6	596.3	953.3	1191.3
GH1	1191.3	1548.3	1786.3
GH2	1508.5	1865.5	2103.5
<b>1990</b>			
290	273.0	535.9	719.9
450	171.3	393.6	575.0
570	107.8	288.7	455.8
580	124.8	321.9	495.8
675	109.1	283.7	447.2
ST6	334.3	691.3	929.3
GH1	1278.8	1635.8	1873.8
GH2	1629.7	1986.7	2224.7
<b>1991</b>			
ST6	603.5	947.9	1185.9
GH1	1318.5	1714.5	1978.5
GH2	1742.0	2138.0	2402.0

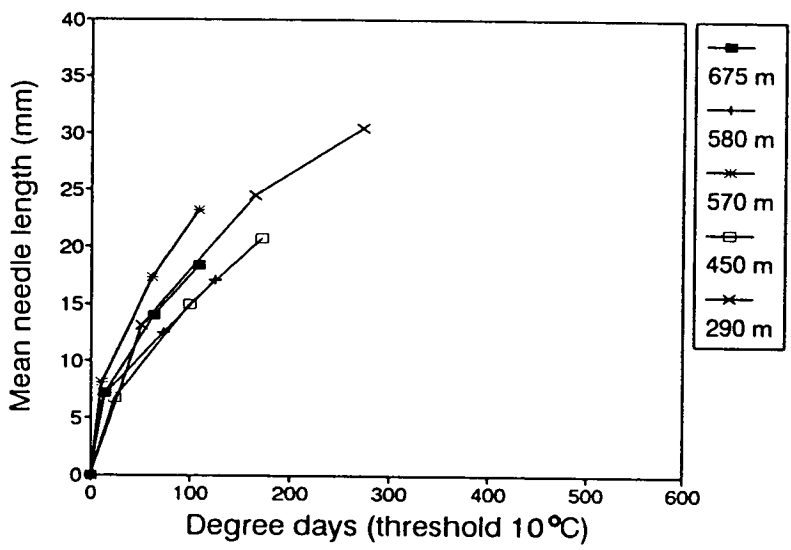
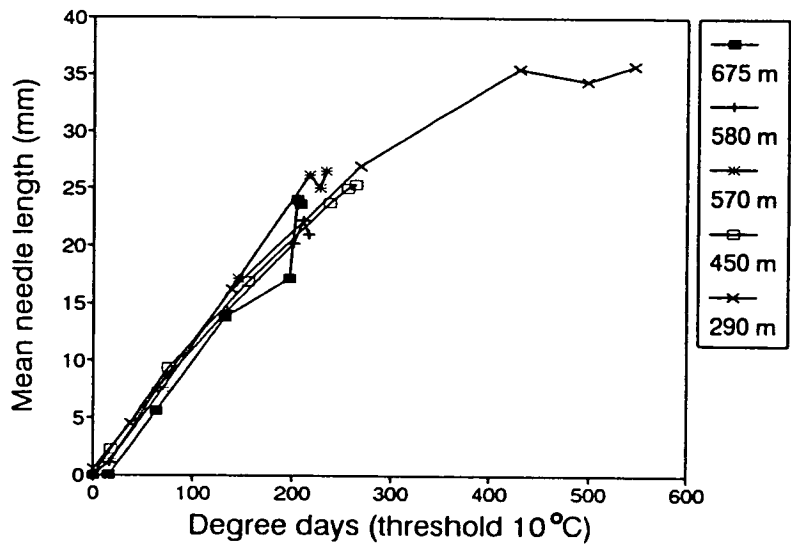

**Figure 2.17:** Relationship between mean needle length and degree days for native trees; 1989 (upper), 1990 (lower).

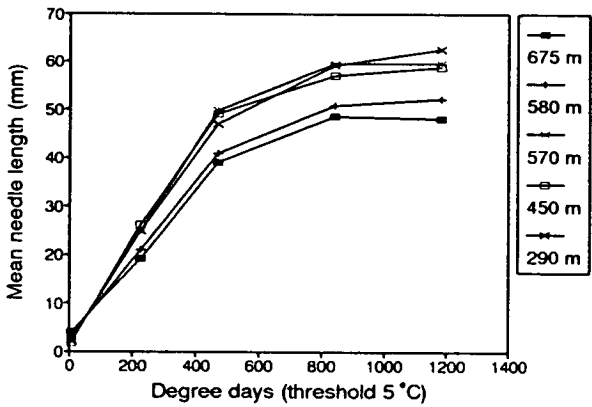
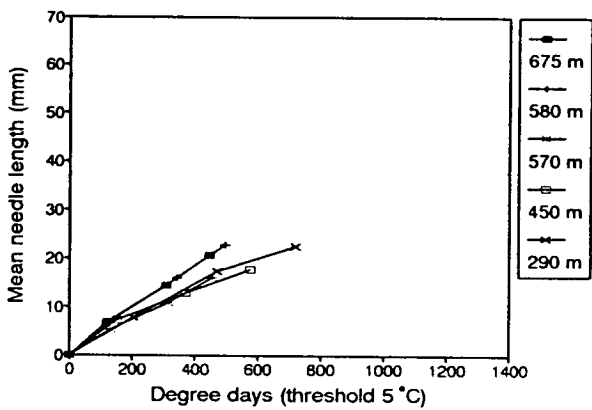
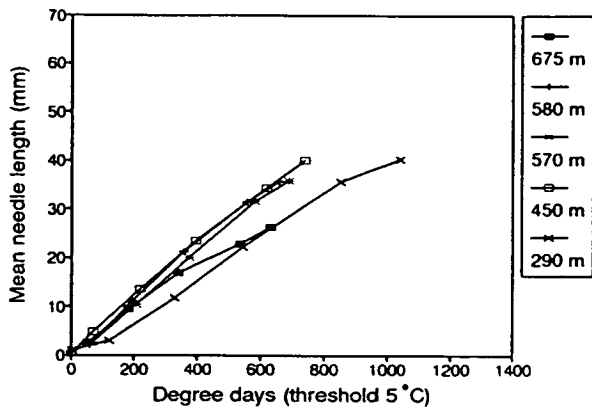

**Figure 2.18:** Relationship between mean needle length and degree days for potted trees; 1989 (upper), 1990 (middle), 1991 (lower).

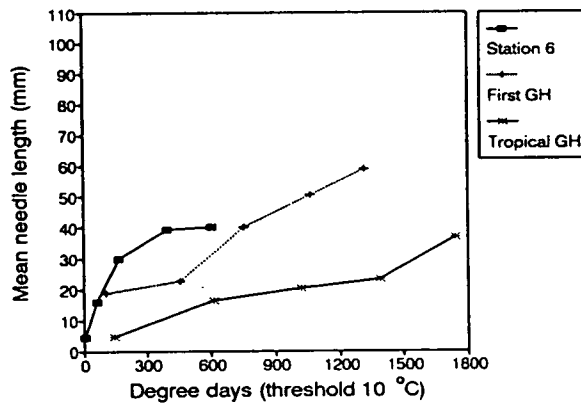
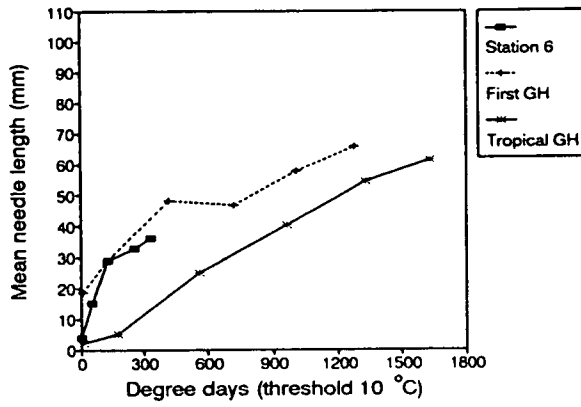
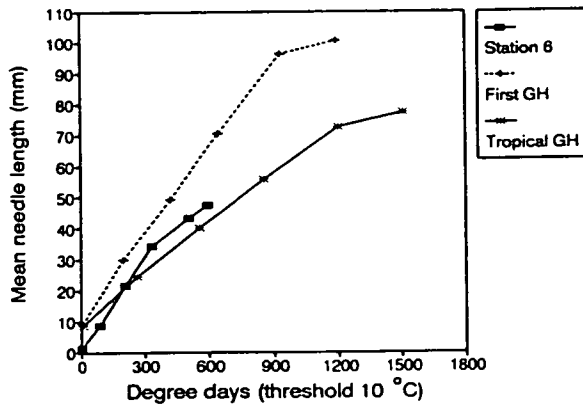

**Figure 2.19:** Relationship between mean needle length and degree days for potted trees at the three Edinburgh stations; 1989 (upper), 1990 (middle), 1991 (lower).

lengths were recorded. Needle length increased with temperature sum, as at the next three highest stations, for approximately 350 degree days and then increased at a slower rate with no further extension after 650.

As for the native trees, the plots for the lowest stations extended beyond those for the others as greater sums of temperature resulted in further needle extension. The results for 1990 showed a grouping between the slopes of the top two stations and those of the three lowest. The plots for the two highest altitudes were above those for the others with greater needle lengths after an equal number of degree days. Stations 1 and 3 experienced the least total temperature sum at the site in this year and as before, plots for stations 4 and 5 extended beyond the others.

The data for 1991 show differences between the response of the plants from the five stations even though they all experienced a similar temperature sum in this year. The greatest mean needle length was achieved by the trees from station 5 (290 m) and the smallest by those from station 1 (675 m).

The results for the three Edinburgh stations are shown in figure 2.19. Very little similarity exists between the plots for 1989, and that which does becomes progressively less in the subsequent years. One consistent feature in all three graphs is that the plants outside at station 6 complete needle extension after much fewer degree days (300 to 600) than those in either greenhouse (1,200 to 1,800). However, these plots alone give no idea of the comparative duration of the growth periods as the higher temperatures in the greenhouses result in a more rapid accumulation of degree days over the same time interval. The decrease in similarity between the stations over the three years measured suggests that long periods at relatively high temperatures in the greenhouses leads to a change in the plants' growth response to temperature.

#### (iv) Discussion

##### *Height extension*

The mean total height extension of the native trees at Creag Fhiaclach was found to decrease significantly with increasing altitude. This increase in altitude was associated with a decrease in the mean monthly air temperature throughout the summer. By comparing the results (figures 2.1 and 2.3) it can be seen that the most dramatic change between stations occurred between the two lowest altitudes in both cases. Height extension and mean monthly temperature were significantly lower at 450 m than at 290 m and above this changes were more gradual.

That height extension should follow a pattern similar to that of the mean monthly air and meristem temperatures does not invalidate the connection between height growth and the temperatures of the preceding year. When total mean height extension was plotted against the mean meristem temperatures of the previous growth season a positive correlation was found. Similar results have been reported for *P. sylvestris* in Northern Fennoscandia (Junttila and Heide, 1981) although the months used in the correlation were June to August due to the comparatively late start of the growth season in that locality. By comparing the height data with both sets of temperature data it can be seen that the greater heights achieved in 1990 correspond better with the mean temperature of 1989 than with the lower ones of 1990. The actual mean temperatures experienced by the trees (meristem temperatures) were above those of the air in 1989 but lower than the mean air temperatures in 1990, thus exaggerating the fall in temperature between the two years, as experienced by the plants. This reasoning leads to the suggestion that lower temperatures occurred in 1988 before measurements began than in 1989 and also that a decrease in mean total height relative to that of 1990 would have been found in 1991, had the measurements been continued.

Height extension rates of the native trees were greater in 1989 at all altitudes despite total height being smaller in this year. The greater heights achieved in 1990 were reached over a comparatively longer period of growth (the maximum growth period lasted for 32 days in 1990 compared to 21 days in 1989), possibly as a result of lower temperatures experienced in this year. In contrast, the warmer temperatures experienced by the trees in 1989 promoted rapid growth towards the

total heights "pre-programmed" in a cooler year. The same idea can be applied to the decrease in rates with increasing altitude such that progressively lower rates result from corresponding lower temperatures acting upon the plants. The relatively large change in both temperature and growth rate either side of the tree-line indicates a difference between the microclimates experienced by the trees at these two stations.

The results for the potted trees are rather different with a dramatic decrease in total heights and extension rates from 1989 to 1990. This probably reflects the transference of these plants from a warmer site to a cooler one. In 1989 the total heights resulted from the development of the stem unit primordia under the comparatively warm conditions the plants had received in the previous year at the nursery. A significant decrease in mean total height extension with increasing altitude was found. Since all plants were originally grown together the trend with altitude was less clear in the first growing season after being transferred to Creag Fhiaclach. The effect of lower temperatures on the number of stem units formed during this year was shown clearly in the 1990 results where total heights were much lower than those of the previous year and the decrease with increasing altitude was more apparent. Rates of increase in height were lower in 1990 than in 1989 which reflects the drop in mean temperatures between these years. In the following year, 1991, height results were fairly similar to those of 1990 even though the trees had now been returned to the University grounds. Mean total height extension was positively correlated with the mean meristem temperatures of the previous growth season. Again, this may be attributed to "pre-programming" (1990) while the plants experienced cooler temperatures. The residual altitudinal pattern, however, was not as distinct in the University grounds in 1991 as might have been expected, and suggests at least some influence of the current year temperatures on height growth. The deviation from the expected pattern may have been due to current-year temperature influences as elongation of pre-formed stem units involves cell division and elongation and will therefore be affected by temperature.

The rates of growth were lower in the University grounds in 1991 apart from those of the tree-line plants which showed a slight increase. This was surprising as by moving to a warmer region higher rates of growth would have been expected. The lowest rates were those of the trees at station 1 (675 m) which may be linked to

previous year's temperatures, although a combination of factors are likely to have been particularly influential here.

The trees that were kept at the three Edinburgh stations throughout the study showed varying results. The decrease in mean total height extension was significant between stations and over the three years. In the first year the higher temperatures inside the greenhouses seemed to be the indirect cause of slightly lower total height and reduced rates of extension. The glasshouse plants were notable for their long needles. High respiration rates may have depleted carbohydrate reserves, and possibly nutrients became limiting in this unnaturally rapid rate of needle growth. Possibly higher respiration rates caused by higher temperatures resulted in more energy being allocated to needle growth to increase the potential photosynthetic surface area at the expense of height increase. Rates decreased each year at station 6. The first decrease (from 1989 to 1990) can be related to the comparatively lower temperatures experienced in the 1990 growth season whereas the second decrease (from 1990 to 1991) is probably due to the longer period over which maximum growth took place.

The results of the following year at the Edinburgh stations reflect the effect of stem unit development under elevated temperatures compared to that under ambient conditions. Total height was greatest in the first greenhouse where fairly high mean temperatures during 1989 promoted greater height extension. The rate of extension had more than doubled from 1989 to 1990 and was also substantially higher in the tropical greenhouse. However, in the tropical greenhouse mean total height extension decreased each year which suggests that either the temperatures at this station were in excess of those necessary for the optimal formation of stem unit primordia or that subsequent growth was restricted in some way. The decrease in mean total height extension in both greenhouses from 1990 to 1991 cannot be explained by a corresponding decrease in either mean air or meristem temperatures from 1989 to 1990. It should be noted that the results may not reflect a simple correlation between two subsequent summers since temperatures inside the greenhouses may have never been low enough to induce the annual hardening and chilling phases necessary for Scots pine to develop normally and hence the tree's growth cycles became disrupted. This suggestion is in accordance with the results from studies on chilling requirements such as that by Murray *et al.*, (1989). These authors showed that for many woody species growing in Britain under temperatures

exceeding those necessary for normal chilling requirements to take place, the subsequent time to budburst is delayed.

For the trees at Creag Fhiaclach the results of total height and height extension rates agree with those of other authors. Tranquillini (1979) found the commencement of shoot growth to be delayed with increasing altitude for *Larix decidua* whereas cessation was more closely synchronised and thus the total growth period also decreased with increasing altitude. In the present work although onset of growth was delayed at higher altitudes a simultaneous cessation of height extension at all altitudes was shown by the native trees but did not occur amongst the potted trees (figure 2.8). Of the potted plants, those at 450 m completed growth first by the end of June, those at 675 m last, by mid-August, and the rest together by mid-July. Cessation of growth is usually thought to be determined by photoperiod but as photoperiod does not vary with altitude it is suggested that additional factors are involved in this case. For Scots pine bud development is delayed with increasing altitude as low temperatures prolong the setting of a dormant bud (Benecke and Morris, 1978 (unseen), cited by Tranquillini, 1979). This effect applies particularly to young seedlings which are then prone to shoot damage at high altitudes. In comparison, it has been found that lateral bud formation in *Pinus contorta* and *Picea sitchensis* in Scotland are more affected by apical and extension growth than by temperature, daylength and nutritional treatments (Cannell, 1974).

Junttila (1986) found the optimum constant temperature for elongation growth to be between 18 and 21 °C for Scots pine trees grown in a phytotron. His trees were of northern provenance. These values of temperature encompass those experienced by the plants in the first greenhouse in the present work and under which most growth took place. In the same set of experiments Junttila found final shoot length to be significantly affected by temperatures experienced during shoot elongation and the rate of elongation to be positively correlated with the number of stem units. Positive correlations of mean total height extension with current year mean meristem temperatures were also found in the present work but were not taken to be conclusive results since current and previous year temperatures were likely to be positively correlated with each other.

The results for station 6 can be regarded as an indicator of how much growth the other potted plants may have achieved had they remained outside the University. That all such plants at the field site grew less than those at the University suggests that their potential growth was limited by climatic factors at Creag Fhiaclach. A direct comparison between these potted trees and the native ones measured at each altitude, however, is not possible. The native trees were older than the potted ones and had much slower rates of growth. Also their more bushy form suggested that current year growth was distributed more evenly over the whole tree with less emphasis on any individual shoot as often no true leader was present.

### ***Fascicle numbers***

For *Pinus sylvestris* the number of needle fascicles has been positively correlated with the mean June to August temperatures of the previous summer (Junttila and Heide, 1981). In the present work this carry-over effect or "pre-programming" leads to the suggestion that the summer temperatures of 1988 were generally warmer than those of 1989, (as mentioned earlier in the case of height extension) since numbers decreased from 1989 to 1990 and the variation with year was significant. The mean number of fascicles were positively correlated with the mean meristem temperatures of the previous growth season.

Relationships with altitude were found to be significant for all trees at the field site, the number of needle fascicles decreasing with increasing elevation.

At the Edinburgh stations the mean numbers of fascicles produced inside the greenhouses were significantly lower than those outside in 1990 and 1991. More similar results were shown between the three stations in the first year of measurement (ie. the first season after transferral to the greenhouses) which again suggests a carry-over effect of temperature.

Correlations between the number of fascicles produced in 1991 and the previous year mean meristem temperatures were positive for the potted trees brought back from the field site together with those from station 6. This is the strongest indication that fascicle numbers are determined in the previous year.

### *Needle length*

Needle length can usually be correlated with current year temperatures. This is reflected clearly in the results where final mean needle length of the native trees was found to be positively correlated with the mean air temperatures of the current growth season. Needle lengths of the native trees were all slightly shorter in 1990 when temperatures were correspondingly lower. The relationship between mean needle length and degree days was very similar at all altitudes in the first year of measurements but was less so in 1990 when a distinct change in rate of increase after 20 to 30 degree days was also observed. 1990 was a cooler growth season and therefore temperatures were accumulated more gradually and resulted in relatively shorter needles. Effects of this, or additional factors, may have caused changes in the threshold values at different altitudes which could account for the variation shown.

For the potted trees the difference in total needle length attained between the two years was greater than that of the native trees in all cases although mean length was shorter than those kept at the University. A significant decrease in total needle length with increasing altitude was shown for native and potted trees although the trend was not clear in 1990 for the potted trees. This could have been a result of slight differences in temperature fluctuations between stations which may be the cause of the deviation in temperature gradient seen in May and August (figure 2.1) of that year, both months having been warmer than average.

Plots against degree days were approximately equal for the two years at the field site as far as differences between altitudes were concerned. However, the slopes or rates of increase were lower in 1990. A distinct altitudinal trend was shown in 1991 indicating a "carry-over" effect of temperature on needle growth from the previous year. Although the relationship between mean needle length and previous year temperatures was not found to be significant this trend could reflect an altitudinal influence on needle development possibly through threshold levels where trees at the higher altitudes develop slightly higher thresholds for growth. Alternatively, the altitudinal trend could be the result of the combined effect of

temperature and water availability in the year prior to, and during, shoot growth (Cannell *et al.*, 1976).

The pattern in total needle length of the trees outside the greenhouses at Edinburgh followed comparable changes in mean temperature and did not fluctuate by more than 10 mm overall. The relationship between the three Edinburgh stations was not found to be significant. The steep decline in total needle length from year to year in the two greenhouses only corresponded with a decrease in summer (June, July and August) temperatures for 1990 to 1991. The change in mean length between the first two years of measurements must be attributed to influences other than the direct effect of temperature as a decrease occurred despite higher mean temperatures in the second year. Nevertheless the total needle lengths remained higher than those of the trees outside the greenhouses during 1990.

The relationships with degree days were inconclusive due to the differences in the timing of the growth cycles between the indoor and outside plants. However, the plots for station 6 more closely resembled those of the first greenhouse in that plants had reached similar needle lengths (when those outside were fully extended) after an equal number of degree days each year.

The decline in total mean needle length within the greenhouses from year to year is probably due to a combination of factors. It may be very significant that only five of the eight trees survived to the second year in the tropical greenhouse and only four survived in the first greenhouse. Results for 1990 and 1991 are therefore based on data from a smaller number of plants and so individual variation is more pronounced in the final means. Had all plants survived throughout the three years results may have showed a better correlation with mean temperatures. The larger decrease between 1989 and 1990 occurred in the first greenhouse and could be linked to the fact that fewer trees survived here. Between the measurements of 1990 and those of 1991 a further death occurred in the tropical greenhouse.

Another factor is that of annual growth cycle disruption, mentioned earlier. Disruptions were thought to have been due chiefly to the combination of unnatural light regimes imposed on the plants from other experiments within other parts of the greenhouses, and the continuously high temperatures which prevented pre-winter hardening processes to take place. Although growth patterns appeared

normal throughout 1989 several trees inside the greenhouses produced a second or even third flush in mid-summer and late autumn. This introduced measurement problems since needles measured previously stopped growing when new needles were produced. The terminal shoot on a number of trees either died or lost leadership and in others new whorls were produced without a central shoot. In these cases measurements were made on the visibly strongest lateral shoot.

By 1991 all surviving trees were very different in appearance to those growing outside. In the first greenhouse branches tended to be very upright in their angle from the stem and bore very long needles. Towards the top of the plants the characteristic whorls were indistinct. The trees in the tropical greenhouse were of a more usual form but became noticeably more stunted each year as height increments declined.

In addition to changes induced in their endogenous rhythm, the greenhouse trees were also more prone to attack by pests as the warm conditions provided a suitable environment in which insects could thrive. During 1990 a brown scale insect was observed on all plants in the tropical greenhouse and by the following year was seen on all those in the first greenhouse as well.

Needle abnormalities were observed on several trees across the entire experiment. The most common were curled-over tips and the presence of three needles within a single fascicle. Both of these occurred throughout the potted trees but curled tips were more frequent on those within the greenhouses. It has been suggested that fascicles containing three needles are produced as a response to counteract a reduced photosynthetic surface caused by low numbers of fascicles developing as a result of cool summers (Junttila and Heide, 1981). This link to temperature was also suggested by the work of Benecke and Havranek (1980) in the Craigieburn Range of New Zealand where three-needled fascicles were found to be more common in *P. sylvestris* at higher altitudes (1330 m) than at lower (1120 m) and were absent at those lower still (890 m).

Junttila and Heide (1981) found the frequency of three needles in *P. sylvestris* to be negatively related to the June to August temperatures of the previous summer. Since trees displaying this phenomenon in the present work were grown under the same conditions as those which did not, it is possible that such incidence is

controlled by individual susceptibility to low temperatures, with the more susceptible trees having a greater probability of producing three-needed fascicles. Such susceptibility may result from an inherent genetic response.

### *Needle survival*

The number of fascicles surviving from year to year showed a significant relationship with altitude. The extent of needle loss over winter has several implications on the survival of the whole plant as the number and length of the needles together make up the potential photosynthetic surface area. Any loss in numbers will reduce this area and may thereby restrict the growth in the following year.

The degree of development at which needles enter the winter months has also been considered an important factor determining needle survival (Baig and Tranquillini, 1976) and is related to the length of the development period such that needles at higher altitudes with shorter growth seasons are more susceptible to winter damage, (this idea is discussed in chapter 3).

Mechanical abrasion by wind and the impaction of wind-blown particles cause damage which may increase transpiration and lead to desiccation (Grace, 1990; van Gardingen *et al.*, 1991). Any form of damage to needles will also increase the vulnerability of the plant to disease and to other "knock-on" effects and will reduce its survival potential.

### *General discussion*

From the results it is clear that altitude has an effect on the height extension, fascicle number and needle length of *P. sylvestris* at Creag Fhiaclach. Throughout, this effect has been attributed to temperature, either directly or indirectly, acting on total growth and rates of extension. Mean monthly air and meristem temperatures decreased with increasing altitude. Growth was also found to decrease with

increasing altitude. Since temperature (within a certain range) is an essential requirement for the growth and development of plants and as soil and provenance differences had been eliminated changes observed in the growth of the potted plants in this study are considered to be primarily due to temperature.

Many factors may influence growth patterns under field conditions, however, and beyond temperature, no attempt was made to determine the effects of these other variables. At Creag Fhiaclach differences in the microclimates of the stations may well have included the degree of exposure to which the plants were subjected. The relationship between the heights of the potted trees and that of the surrounding vegetation may have exerted significant shelter effects and rendered the trees at higher altitudes more prone to damage. Such damage could include both biotic and abiotic factors and may take the form of grazing, trampling and disease, or drying, waterlogging and mechanical abrasion, respectively. Open sites were chosen for the establishment of all stations with roughly similar surrounding vegetation in an effort to reduce the differences of such effects. No attempt was made to control the actual effects acting upon the trees, however, since conditions were required to be as natural as possible. Despite these considerations the plants placed at the highest altitude were undoubtedly more exposed than those at other stations because the surrounding heather (*Calluna vulgaris*) was notably shorter here and the nearest protective trees were much further away than at other altitudes.

To some extent the effect of wind on the temperatures experienced by the plants was incorporated in the study. By measuring the air temperatures above the potted trees and comparing them with the actual meristem temperatures of the plants an idea of the degree of coupling between the plants and the atmosphere can be gained. As short vegetation is more aerodynamically resistant to heat transfer, smaller, low-growing plants tend to experience larger surface-to-air temperature differentials than taller ones (Wilson *et al.*, 1987). In the present work all trees measured at the highest station were of a similar height and size but at other stations the comparatively larger size of the native trees may have caused them to experience temperatures closer to those of the air than to those experienced by the potted trees. If this was the case the native trees would have been growing at mean temperatures below those of the potted trees during 1989 and above them in 1990. This would have been particularly true for height extension growth since the May

and June meristem temperatures were more consistently above or below those of the air during these months in both years.

Either side of the tree-line the difference in mean monthly meristem temperatures was sufficiently large as to appear as a distinct "step" from 570 m down to 580 m when plotted against altitude, notably so in 1990. This relatively large change over only 10 m in altitude and 50 m along the ground could be a direct cause of the position of the tree-line at this site. During May and June in 1990 the trees just below the tree-line experienced mean monthly temperatures greater than those of the air whereas those immediately above the tree-line experienced mean temperatures lower than those of the air. Possibly this situation was created by the difference in the cooling effect of wind between the two stations, and also the period of time the meristems were wet from cloudwater. Above the tree-line the windspeeds are likely to be higher, and the meristems may be wetted more often by clouds and rain. Since this relationship between mean air and meristem temperatures at the tree-line was not present in 1989 and measurements were only made in these two years it is not known whether this is the usual temperature pattern that occurs here in the growth season.

No measurements of light were made at the site (apart from those during measurements of photosynthesis, chapter 5) although some differences were noticed between stations on several visits caused by localised cloud cover or mist. A study carried out along a similar transect at this site by Wilson *et al.* (1987) showed a variation in mean net radiation between stations at different elevations of up to  $10 \text{ Wm}^{-2}$  per 100 m (between 650 m and 850 m a gradient of  $12 \text{ Wm}^{-2}$  per 100 m was recorded), values decreasing with increasing altitude. Showers of rain were often observed to move across the valley in a westerly direction and reach the stations at different intervals. Occasionally rain fell only in the valley leaving the hill-side dry, and sometimes mist would form along the upper slopes while the valley remained clear. Formation of mist, fog or low cloud on the upper slopes at this site could contribute substantially to the input of water and atmospheric pollutants to the plants in this region and thereby increase differences in the microclimates experienced at the range of altitudes studied. Cloud and fog droplets may contain a wide range of elements at concentrations above those in rainfall deposited in the same area (Dollard *et al.*, 1983). These authors carried out work in the Great Dun Fell region in Cumbria and showed that a large variation in the

frequency and duration of low cloud occurred between stations at different altitudes with over 200 more cloud days occurring at 850 m than at a station 290 m lower. It is therefore likely that the trees at and above the tree-line in the current work were subjected to much greater atmospheric inputs than those at other stations and that this may be a significant factor affecting growth in this area. Partly as a result of the observations made during the present study measurements of needle water potentials and nutrient content were made and are described in chapter 4.

To obtain an overall view of the effect of temperature change with altitude on native *P. sylvestris* it may be necessary to determine not only phenotypic responses of trees at a variety of elevations but also to investigate any genotypic differences that may exist between them. Microclimate is of major importance and should not be underrated as it influences the way in which plants adapt to, and react with, their surrounding environment and may exert strong selection pressures on seedlings. Sensitivity to fluctuations in climatic conditions through threshold levels and differences in the length of time suitable for growth each year are important considerations to be taken into account with respect to altitude.

## (v) Conclusions

1. The null hypotheses were rejected: *Pinus sylvestris* does not grow equally at all altitudes and the variation in growth along an altitudinal transect can be accounted for at least in part by variation in temperature.
2. Mean monthly air and meristem temperatures decrease with increasing altitude. Environmental lapse rates vary between months and between years. Mean monthly meristem temperatures differ from mean monthly air temperatures by as much as 3.8 °C.
3. Height extension, fascicle numbers, percentage needle survival and needle length decrease with increasing altitude.
4. Mean height extension and the mean number of needle fascicles is positively correlated with mean meristem temperatures of the previous (May to June) growth season. No correlation exists between mean needle length and the mean air temperatures of the previous (May to August) growth season.

## CHAPTER 3 : CUTICULAR DEVELOPMENT OF *P. sylvestris* ALONG AN ALTITUDINAL TRANSECT.

### (i) Introduction

In the past it has been proposed that the position of the tree-line may be determined by the stage of development at which the cuticles of the needles enter the winter months, where poorly- or under-developed cuticles result in needle desiccation and eventually death (Wardle, 1971; Tranquillini, 1979; Lange and Schulze, 1966 (unseen) cited by Tranquillini, 1979). Developmental stage of cuticles has been related to the duration of the growth period and, through this, to altitude. Light microscopy has been used to measure cuticular thickness (Baig and Tranquillini, 1976) even though the thickness of the cuticle is sometimes less than the wavelength of light, and thus not measurable by this technique.

It was decided that measurements of cuticle thickness by an alternative technique should be carried out at intervals throughout the growing season along an altitudinal transect to determine any differences between trees at different elevations. The null hypothesis for this investigation was as follows;

$H_0$ : The needle cuticles of *Pinus sylvestris* develop equally at all altitudes.

Cuticle development was assessed with a gravimetric technique, expressed on a weight per surface area basis and carried out after the cuticles had been isolated by means of acid digestion. It was considered that this would yield a more reliable estimation than light microscopy.

Isolation of cuticular membranes by methods of digestion using nitric and chromic acids have been carried out since the early 1800s (Martin and Juniper, 1970). Some controversy exists between authors over the use of acid as a digestion medium. It has been reported that isolation by this method does not leave the cuticular membrane structurally and functionally intact (Lendzian *et al.*, 1986) and therefore is of no value for use in further measurements such as those for the determination of water permeance. Alternative methods of isolation have included

the use of filtrates from culture solutions of *Bacterium aroideae* (Wood *et al.*, 1952, unseen, cited by Orgell, 1955) and anaerobic bacterial fermentation on leaves of *Nicotiana glauca* (Skoss, 1953, unseen, cited by Martin and Juniper, 1970).

Later, Orgell (1955) established the use of pectic enzyme preparations for isolation of various angiosperm cuticles. This technique and adaptations of it, frequently fungal pectinases, have been widely used (for example Schönherr and Riederer, 1986; Riederer and Schönherr, 1988). These authors isolated cuticles from leaf disks of *Ficus* plants by means of fungal pectinase and cellulase dissolved in aqueous buffers. Similar methods have been used on *Citrus* leaves (Geyer and Schönherr, 1990) and on coniferous species (Lendzian *et al.*, 1986). However, digestion by the enzyme driselase (2% driselase in a sodium acetate buffer solution) was found to be ineffective for Scots pine cuticles in the present work. Driselase is a combination of extracts from Basidiomycetes with a protein content of approximately 15%; it contains laminarinase, xylanase and cellulase which provide digestive action (Driselase D 9515, Sigma Chemical Co., Ltd., Poole, Dorset, England). As cutinases derived from fungi are usually esterases which cleave only ester bonds between cutin monomers (Kolattukudy, 1981), it is possible that this enzyme could not penetrate cuticles of *P. sylvestris*, particularly those that are fully-developed, or older needles due to the presence of a non-ester fraction of the cutin (Riederer and Schönherr, 1988; Riederer, 1989).

Plant cuticles are layered structures containing regions of non-uniform physical properties and chemical composition. They can be divided into three main zones: the cuticle proper (a lamellate layer), below this the cuticular layer (a reticulate region), and then a pectinaceous layer continuous with the middle lamella (Jeffree, 1986). A detailed account of the structure, composition and transport properties of conifer cuticles is given by Riederer (1989). The generalised structure of a plant cuticle is shown in figure 3.1. Many gymnosperms differ from this by having significant cuticularisation of the anticlinal cell walls of the epidermis.

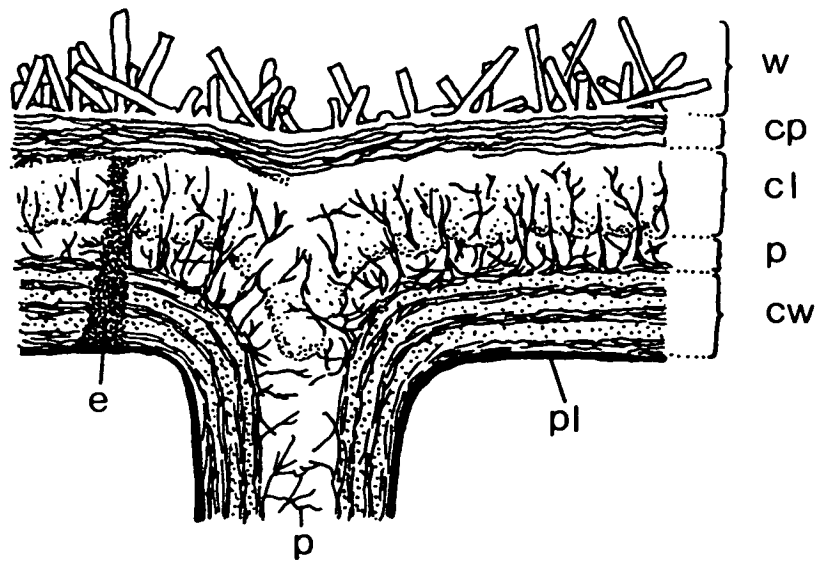

**Figure 3.1 :** Generalised structure of a plant cuticle; ectodesmata (e), pectinaceous layer and middle lamella (p), plasmalemma (pl), epicuticular wax (w), cuticle proper (cp), cuticular layer or reticulate region, traversed by cellulose microfibrils (cl), cell wall (cw). Redrawn from Jeffree (1986).

## (ii) Materials and methods

Needle fascicles were collected from the potted *P. sylvestris* trees along an altitudinal transect at Creag Fhiaclach, as described in the previous chapter. Eight current year fascicles were sampled from the trees at each station, two from each of four plants. They were placed into plastic specimen jars containing moist, soft cloth and were returned to the laboratory where they were placed in a refrigerator at 4 °C. Collections of fascicles were made on the following days in 1989;

- 29 June
- 19 July
- 17 August
- 13 September
- 12 October

To evaluate needle weight per surface area, individual needles were weighed (fresh weight) on a Sauter RE 1614 balance (August Sauter GmbH, Ebingen, Germany).

The surface area of each needle was determined using a glass bead technique derived from the procedure of Thompson and Leyton (1971). This method was chosen for its suitability for use on pine needles which do not lie flat (Davies and Benecke, 1980) and for its accuracy over methods which do not allow for the curvature factor involved with these needles as a result of their morphology (Drew and Running, 1975). Each needle was briefly immersed in a 10% (v/v) solution of pressure-sensitive glue (EvoStik 528, Evode Ltd., Stafford, England) dissolved in 1,1,1-trichloroethylene (86% v/v) and butanol (4% v/v). The glue was sufficiently dilute to ensure a thin, even coating of the needles with any excess running off as the needles were removed from the solution. After a short drying period at room temperature needles were individually placed into a pre-weighed glass Petri dish containing grade 14 Ballotini solid glass balls (Jencons (Scientific) Ltd., Leighton Buzzard, Bedfordshire, England). The dish was carefully rotated to ensure complete coating of the needle without loss of any balls from the dish. Each needle was carefully tapped and shaken to remove any excess balls and then examined under a binocular microscope to ensure that a monolayer of glass balls adhered to the whole surface. The glass dish containing the remaining balls was

re-weighed and the change in weight was recorded as the weight of balls taken up onto the needle.

A calibration factor relating glass ball weight to surface area was applied to the results to determine the surface area of each needle. The calibration factor had been determined previously through linear regression by coating lengths of copper wire of accurately known area (approximately equal in length and diameter to the needles) in Ballotini balls and recording the changes in weight of the balls before and after dipping.

Needles were then immersed in 1,1,1-trichloroethylene for 5 minutes to remove the glass balls and the glue solution. The flattened side of each needle was then scored longitudinally and the whole needle was cut in half transversely and both pieces were placed in a 1.5cm<sup>3</sup> polypropylen micro-centrifuge test tube (Scotlab, Bellshill, Scotland). A 5% mixture of chromic acid (5% CrO<sub>3</sub> and 5% HNO<sub>3</sub>) was pipetted into each tube to completely cover the needles. Tubes were placed in an incubator at 20 °C for 7 days. On the seventh day the acid was renewed and incubation continued for a total of 12 days.

Cuticular weight per surface area was then determined. On the twelfth day the cuticle isolates were removed from the acid and washed gently in distilled water to remove any remaining epidermal debris adhering to them. The isolated cuticle from each tube was placed on a small piece of pre-weighed aluminium foil and oven dried at 80 °C for 20 minutes. Each piece of foil was then re-weighed and the dry weight per surface area was calculated for each needle measured. All weights in this part of the investigation were obtained using a Cahn microbalance (Cahn electrobalance model 4700, Cahn Instruments, California, U.S.A.), with a resolution of 10 µg.

A test run of these methods was carried out prior to these measurements in order to confirm that the period of digestion was sufficient to remove all cells other than those of the cuticle and that the remaining cuticle was structurally intact. This was achieved by preparing a series of needles in the acid mixture and leaving them to be digested over a range of incubation periods. The isolated cuticles were carefully mounted onto aluminium stubs and were viewed under a scanning electron microscope (Stereoscan 90, Cambridge Instruments, Cambridge, England)

after being sputter-coated with gold to conduct the current of the electron beam to earth. This coating was a preventative measure to avoid specimen damage and image distortion.

A further test involved the examination of isolated cuticles which had been incubated in acid for more than 12 days (13 to 21 days) to determine whether prolonged incubation resulted in structural damage to, or breakdown of, the cuticle.

### **(iii) Results**

The cuticles were found to be clean and intact after 12 days of treatment (having renewed the acid once in this time), (plate 3.1). After shorter periods of digestion (9 days) or without acid renewal some epidermal debris remained.

The electron micrographs in plates 3.2 and 3.3 show that the structure of the cuticle is maintained even after 21 days in the acid mixture. The invaginations on the inner surface of the cuticle are where the anticlinal walls of the epidermis were cuticularised. There is no sign of erosion, and, in fact, the appearance of the cuticles from the longer incubation treatments are indistinguishable from those of the shorter ones. This result was taken as confirmation that after 12 days of incubation cuticles were not structurally altered by the effects of acid.

#### ***Needle weight per surface area***

Table 3.1 shows the mean needle fresh weights per surface area for the potted trees at Creag Fhiaclach during 1989. Values ranged from 27.1 to 63.6  $\mu\text{g mm}^{-2}$  and did not show a clear pattern with altitude. Needle weights per surface area increased significantly with time ( $P=0.0001$ ), notably so between June and July at all stations. Values stabilised from August onwards in most cases.

The results for the potted trees at the Edinburgh stations are shown in table 3.2. As for those of the field site trees, needle weight per surface area increased with time at each station. Variation between stations was not apparent in June or July but in August and September values were highest for the plants at station 6 and lowest in the tropical greenhouse.

#### ***Cuticle weight per surface area***

Table 3.3 shows the cuticle weights per surface area for the potted trees at the field site. No clear trend with altitude is obvious but some increase with time can be seen up until September, after which four of the five stations show a decrease.

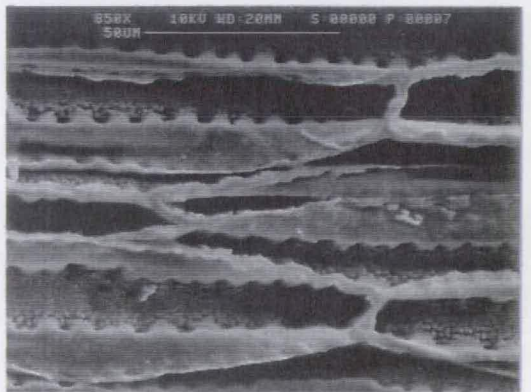
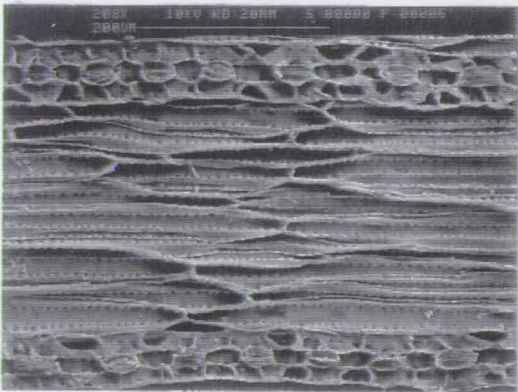
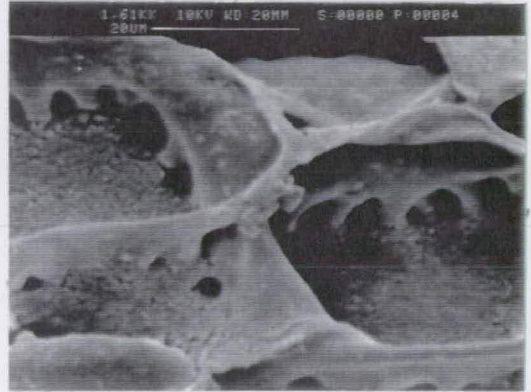
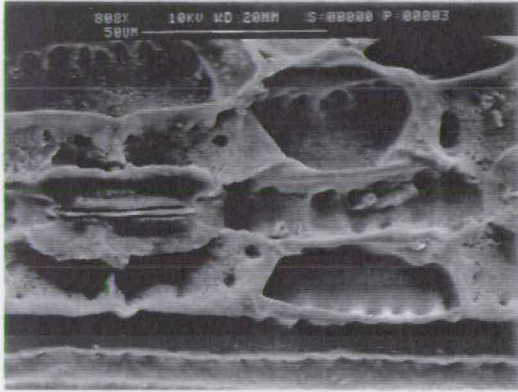
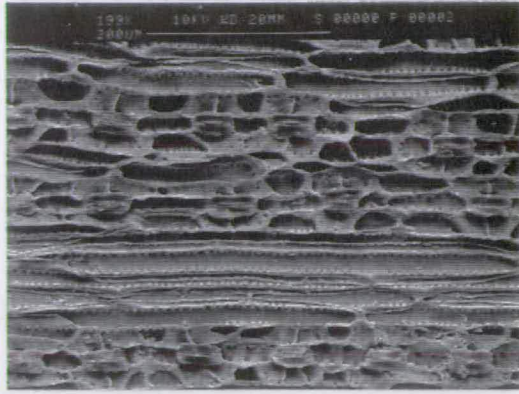

**Plate 3.1 :** Scanning electron micrographs (with magnification) of the inner surface of isolated *P. sylvestris* cuticles of current year needles after 12 days incubation in a 5% mixture of chromic acid at 20 °C. Upper three show different magnifications of one region, lower two are magnifications of an area of a different needle.

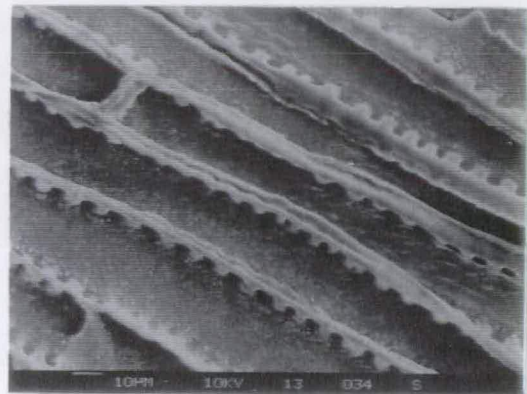
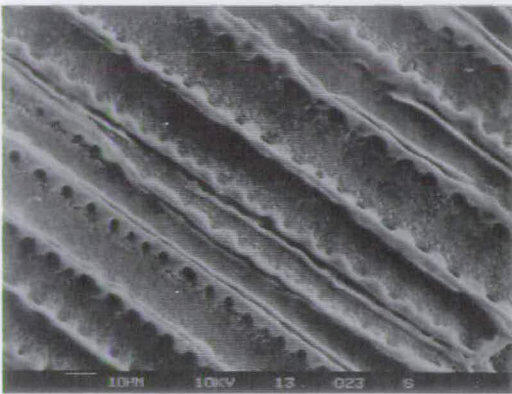
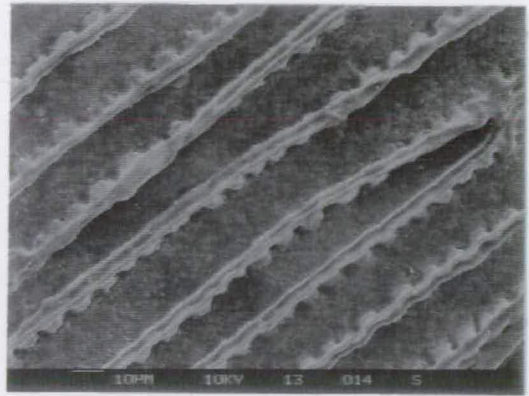
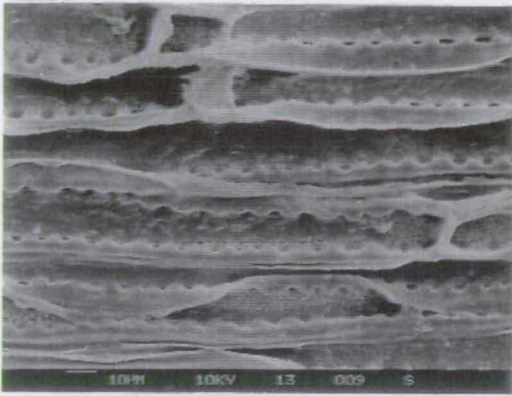

**Plate 3.2 :** Scanning electron micrographs (with magnifications) of the inner surface of isolated *P. sylvestris* cuticles of current year needles after incubation at 20 °C in a 5% mixture of chromic acid for 14 (upper left), 15 (upper right), 19 (lower left) and 21 (lower right) days.

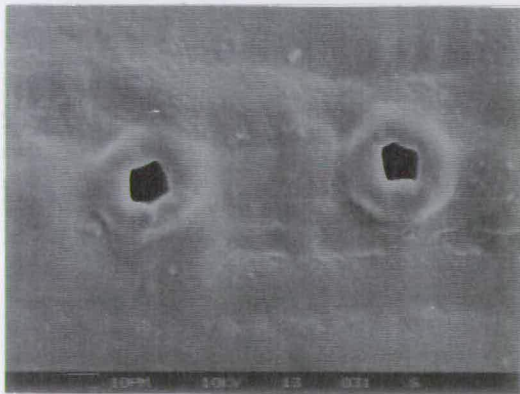
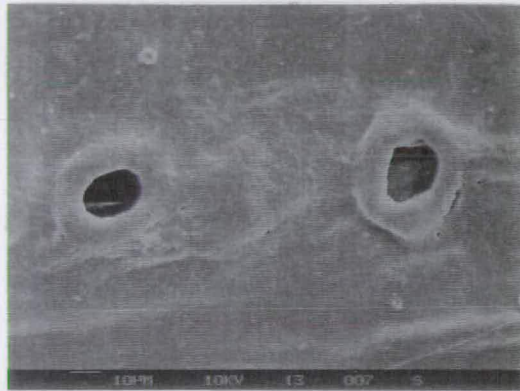
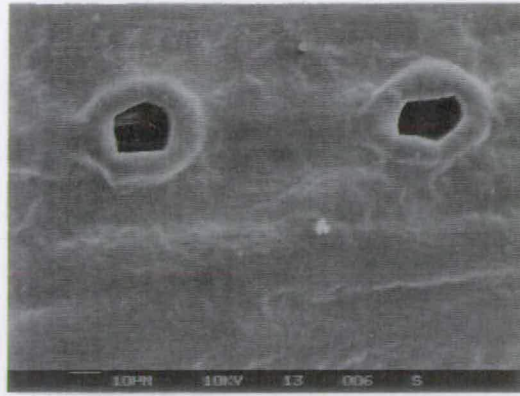

**Plate 3.3 :** Scanning electron micrographs (with magnifications) of the outer surface of isolated *P. sylvestris* cuticles of current year needles after incubation at 20 °C in a 5% mixture of chromic acid for 13 (upper), 14 (middle) and 20 (lower) days.

**Table 3.1 :** Needle fresh weight per surface area ( $\mu\text{g mm}^{-2}$ ) of potted *P. sylvestris* at Creag Fhiaclach. Mean values per station in 1989 with standard errors (n=4). (Column and row means in italics).

Month	Altitude (m)					
	290	450	570	580	675	
June	27.1	30.6	33.4	33.1	30.0	<i>30.8</i>
s.e.	2.7	2.4	4.6	1.0	1.2	
July	45.0	57.6	39.8	41.0	48.3	<i>46.3</i>
s.e.	6.6	7.4	3.3	3.2	3.4	
August	49.4	51.8	48.2	52.4	51.4	<i>50.6</i>
s.e.	6.2	2.5	4.7	6.6	2.3	
September	49.0	49.0	55.8	57.0	54.4	<i>53.0</i>
s.e.	4.1	1.9	3.6	4.8	1.7	
October	63.6	53.0	48.3	57.6	56.4	<i>55.8</i>
s.e.	12.1	2.8	3.7	7.1	6.3	
	<i>46.8</i>	<i>48.4</i>	<i>45.1</i>	<i>48.2</i>	<i>48.1</i>	

**Table 3.2 :** Needle fresh weight per surface area ( $\mu\text{g mm}^{-2}$ ) of potted *P. sylvestris* at the Edinburgh stations. Mean values per station in 1989 with standard errors (n=4). (Column and row means in italics).

Month	Station name			
	Station 6	First greenhouse	Tropical greenhouse	
June	38.4	35.8	37.2	<i>37.1</i>
	s.e. 1.7	2.3	5.2	
July	42.8	43.5	42.4	<i>42.9</i>
	s.e. 2.1	1.8	1.5	
August	52.7	46.7	31.6	<i>43.7</i>
	s.e. 1.4	3.6	3.1	
September	58.8	50.6	46.2	<i>51.9</i>
	s.e. 3.6	1.4	4.8	
	<i>48.2</i>	<i>44.2</i>	<i>39.4</i>	

**Table 3.3 :** Cuticle weight per surface area ( $\mu\text{g mm}^{-2}$ ) of potted *P. sylvestris* at Creag Fhiaclach. Mean values per station in 1989 with standard errors (n=4). (Column and row means in italics).

Month	Altitude (m)					
	290	450	570	580	675	
June	4.6	8.0	5.5	4.3	8.0	<i>6.1</i>
s.e.	1.8	4.3	1.4	0.6	3.3	
July	6.6	8.3	4.3	6.8	6.8	<i>6.6</i>
s.e.	1.5	1.6	0.1	0.6	1.5	
August	8.5	10.7	5.8	12.2	10.4	<i>9.5</i>
s.e.	1.7	2.3	1.0	1.2	1.6	
September	7.7	8.3	12.2	10.8	9.0	<i>9.6</i>
s.e.	1.3	1.3	0.8	2.1	0.6	
October	10.8	7.5	10.5	8.7	6.0	<i>8.7</i>
s.e.	5.1	1.9	2.1	2.4	0.5	
	<i>7.6</i>	<i>8.5</i>	<i>7.7</i>	<i>8.6</i>	<i>8.0</i>	

**Table 3.4 :** Cuticle weight per surface area ( $\mu\text{g mm}^{-2}$ ) of potted *P. sylvestris* at the Edinburgh stations. Mean values per station in 1989 with standard errors (n=4). (Column and row means in italics).

---

Month	Station name			
	Station 6	First greenhouse	Tropical greenhouse	
June	7.3	5.8	5.7	<b>6.2</b>
s.e.	0.9	0.4	1.1	
July	8.8	7.4	6.2	<b>7.5</b>
s.e.	1.1	0.6	0.7	
August	7.4	10.9	6.7	<b>8.3</b>
s.e.	0.4	1.3	0.9	
September	8.9	25.1	13.9	<b>16.0</b>
s.e.	1.0	4.0	1.5	
	<b>8.1</b>	<b>12.3</b>	<b>8.1</b>	

Comparable results for the Edinburgh stations also show an increase in cuticle weight per surface area with time, (table 3.4). In both greenhouses the largest increase occurred between August and September, values doubling in each case. The trees in the first greenhouse had greater cuticular weights per surface area than those in the tropical greenhouse throughout the season and greater than those at station 6 from August. The values for station 6 remained fairly constant between months.

Figure 3.2 shows cuticle weight per surface area against altitude for all potted trees. No clear trend with altitude exists for June or July at Creag Fhiaclach but an increase and then decrease (at 675 m) occurred in August. Above 450 m a decrease with altitude was shown in September and October.

At the three Edinburgh stations cuticle weight per surface area increased each month in both greenhouses, dramatically so in September. Little fluctuation occurred with time at station 6 and values before September were greater than those of the tropical greenhouse but within the range of the first greenhouse.

Actual values were within the same range for all trees (with the exception of those in the greenhouses in September) but those at the field site showed greater variation between months. After an analysis of variance on the two separate data sets the relationship of cuticle weight per surface area with time was found to be significant (Creag Fhiaclach,  $P=0.02$ ; Edinburgh,  $P=0.0001$ ) while that with altitude, or between stations, was only significant at Edinburgh ( $P=0.0001$ ).

Mean values of cuticle weight per surface area for the potted trees (excluding those at 290 m) were plotted against altitude for each of the five months measured. A regression analysis was carried out on each plot but no statistically significant positive correlation with altitude was found in any month.  $R$  values were as follows ;

June	$R=0.07$
July	$R=0.38$
August	$R=0.03$
September	$R=0.23$

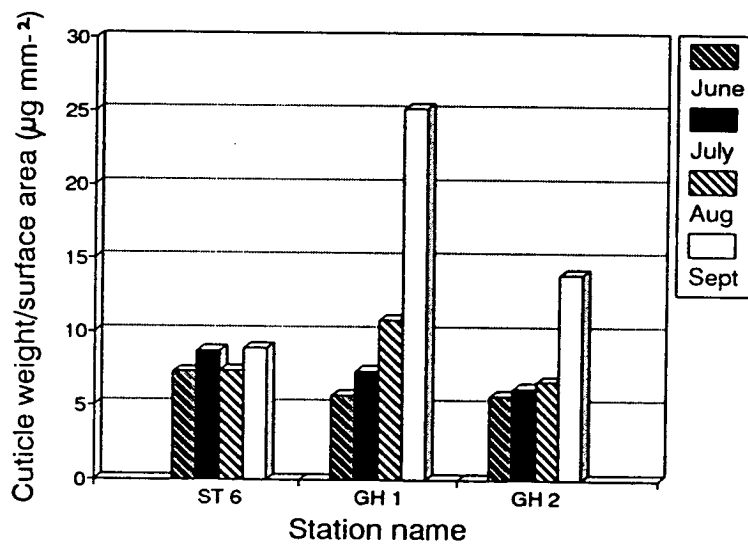
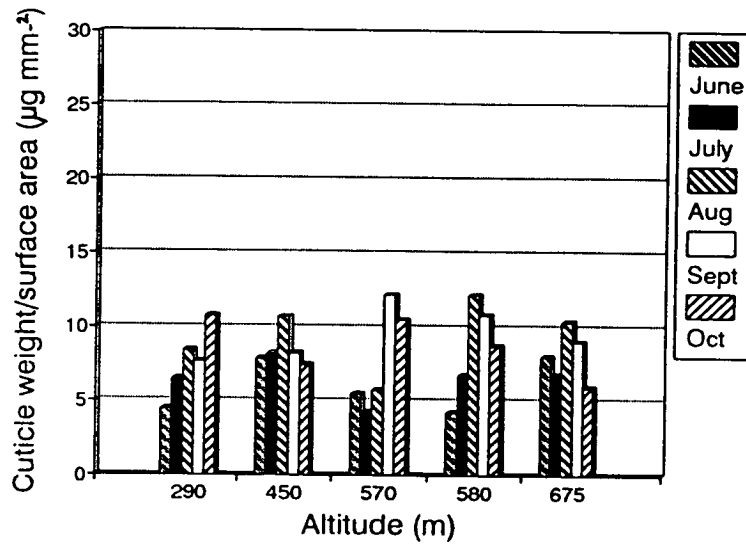

**Figure 3.2 :** Mean cuticular weight per surface area against altitude/station for potted *P. sylvestris* at Creag Fhiaclach (upper) and at Edinburgh (lower), 1989.

October  $R=0.27$ .

The critical  $R$ -value for 2 degrees of freedom is 0.95 at the 5% level of significance.

#### (iv) Discussion

##### *Needle weights*

Needle weights per surface area give an idea of the change in size of needles when viewed over time. At first, the needle fascicles of *P. sylvestris* are short, delicate structures measuring up to about 5 mm in length. As the growing season progresses, the needles increase in length, and to a lesser extent in radius, and they become visibly firmer and appear less fragile. The observed rise in needle weight per surface area can be attributed to the falling surface area to volume ratio as radius increases, as well as to the development of the internal cells and cell contents, and to the laying down of the cuticle.

Although all needles from the potted trees at Creag Fhiaclach showed a pattern which could be explained in this way, variation existed between those from the Edinburgh stations. From August onwards needle weights per surface area were higher outside than inside the greenhouses suggesting that the environmental conditions in the greenhouses were unsuitable for normal development to occur. The relatively low values seen towards the end of the summer, notably so in the tropical greenhouse, suggest that the needles there had a reduced water content. It was noticed that the needles had a leathery feel, were a darker green and were more flexible than those growing outside.

##### *Cuticle weights*

Plant cuticles form a continuous, non-cellular layer on the outer surface of the aerial parts of plants. The cuticle has several functions the chief one of which is restriction of water loss from the plant. The main structural component of the cuticle is cutin (a complex polymer) which, together with surface waxes (non-polymeric), provides the water-retaining properties.

Cutin is composed almost entirely of interesterified aliphatic hydroxy acids, the dominant one in *P. sylvestris* being 9,16-dihydroxyhexadecanoic acid (Hunneman and Eglinton, 1972). These authors used a GLC-MS technique to determine the

structure of cutin acids in a number of conifers and proposed the varying structure to be a valuable aid in taxonomy. (The cutin acid composition of *P. sylvestris* is shown in Appendix III).

Hydroxy acids are also major constituents of leaf waxes of some plants within the Pinaceae and Cupressaceae families (Herbin and Robins, 1968). These authors found the  $\omega$ -hydroxyalkanoic acids of leaf waxes to be valuable as chemotaxonomic criteria, unlike the alkanes which are a minor constituent. Cuticular waxes, or soluble cuticular lipids, can be divided into two distinguishable fractions; intracuticular and epicuticular waxes. Intracuticular waxes are embedded within the cutin matrix (Riederer, 1989). In *P. sylvestris* the epicuticular waxes are present in tufts of tubular structures and are particularly dense over the subsidiary and guard cells, completely filling the antechamber, they form a porous "plug" over the stomata and also form longitudinal strips within the stomatal pore (Riederer, 1989). All regions of the cuticle of *P. sylvestris* are reticulate (Jeffree, 1986).

Other functions of the cuticle are to act as a boundary between the plant and its environment retaining nutrients and small metabolites within the apoplasm, and to give some protection to the leaf surfaces from abrasion by wind and frost (Burgess, 1985). The relatively large mass of the epicuticular waxes and the cuticular layers compared to the thickness of the whole leaf may serve a protective function, particularly against mechanical abrasion where some loss from the surface may occur and reduce the overall cuticular depth.

Plant cuticles are secreted through the outer walls of epidermal cells and develop during the early stages of growth followed by gradual hardening which takes place through oxidation and the polymerisation of hydroxy-fatty acids to form cutin (Martin and Juniper, 1970). In *Clivia* two separate processes have been found to take place in cuticle development; firstly, a lateral expansion during cell expansion resulting in a large increase in surface area, and secondly, the development of a cuticular layer between the cuticle proper and the outer epidermal walls which occurs after cessation of expansion growth (Riederer and Schönherr, 1988). The transport of waxes through the developing cuticular membrane to the plant surface is thought to take place by molecular diffusion through intermolecular spaces in the membrane (Jeffree *et al.*, 1976). Many authors have supported the view that wax

is secreted in a volatile solvent which then evaporates leaving the wax as a deposit (eg. Davis, 1971; Baker, 1974). When comparisons are made between cuticular weight and time the largest increase would therefore be expected in the early stages of growth which would correspond to the main phase of development of the cuticle (as shown in the current work). If a decrease in cuticle weight or thickness was observed after this period it could be suggested that the cuticle was becoming abraded or damaged in some way.

The hypothesis proposed by Tranquillini (1979) which was introduced in chapter 1 (section v) is summarised as a causal chain of relationships in figure 3.3. The first part of this chain is the incomplete development of the cuticle as a result of low temperatures, deficient organic matter, frost during extension growth and late commencement of shoot activity. Cuticles in the present work were found to develop equally at all altitudes and were not thought to be limited in their development by any of these causes at the highest station (675 m) more than at any lower elevation. The relevance of this hypothesis to Scotland is therefore not as strong as it may be for alpine tree-lines and this first link in the chain, at least, is not applicable to more oceanic climates.

The cause leading to the second link in the chain, however, is thought to be more relevant to the current study. Severe abrasion and removal of cuticular surface wax by wind has been shown by Hadley and Smith (1986). Working on *Picea engelmannii* and *Abies lasiocarpa* in the Rocky Mountains in Wyoming they showed that needle mortality was primarily due to winter wind and cuticle abrasion. They also showed cuticular resistance to water loss to be low for wind-exposed shoots of natural *krummholz* (*Picea engelmannii*) and suggested that this might be the reason why only snow-protected needles survive the winter here.

A study on *P. sylvestris* in a wind tunnel to determine the effects of wind abrasion on needle surfaces showed that widespread damage to the epicuticular wax crystals occurs after high windspeed treatment, especially on the cells surrounding the stomatal antechamber and on needle ridges (van Gardingen *et al.*, 1991). However, this abrasion was thought due, at least in part, to the impaction of wind-blown particles and to collision of needle surfaces as the plants moved in the airstream, and was compared to damage observed on needle surfaces in windy locations at high altitudes.

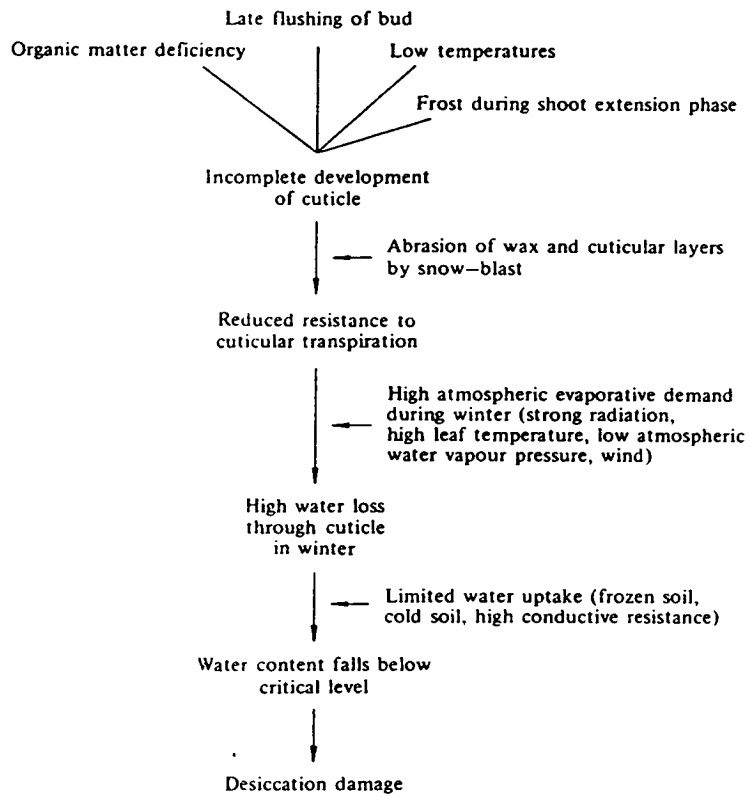

**Figure 3.3:** Model of the causal chain of relationships leading to desiccation of terminal shoots in trees during the winter at timberline. (from Tranquillini, 1979).

An altitudinal effect on the weathering of the epicuticular wax of *P. sylvestris* was shown by Crossley and Fowler (1986). Weathering was found to be significantly different between a site in the Cairngorms at 400 m and one at 200 m at Saltoun in S.E. Scotland, proceeding 20% more rapidly at the higher altitude site. A decrease in cuticle thickness with increasing altitude and wind exposure has also been observed for *P. cembra* and *Picea abies* (Baig and Tranquillini, 1976), although some doubt as to the value of their observations has been cast due to the resolution limitation of a light microscope in measuring cuticular thickness (Grace, 1990).

The results of the present study do not show a significant relationship with altitude even though the uppermost stations were considered to be more exposed than the lower ones, as described in the previous chapter. A similar study on the native *Pinus sylvestris* occurring naturally at the same site also showed no linear trend with altitude, (Grace, 1990). However, in this case epidermal conductance measured on detached needles was found to be higher at 600 m and above, and since it has been suggested that conductance does not recover its original value after one week at low windspeeds (van Gardingen *et al.*, 1991) it is thought that wind is important in modifying the surface properties of ageing needles.

Higher epidermal conductances above 600 m at Creag Fhiaclach have been attributed to stomatal dysfunction (Grace, 1990). Stomata rather than cuticles are therefore likely to be the main route of water loss here. The reduced resistance to cuticular transpiration and high cuticular water loss described by Tranquillini (the second and third link of figure 3.3) are therefore also unlikely to be significant at this site.

A distinct and unexpected decrease in cuticle weight per surface area was shown in the present work at all stations above 290 m between September and October. This decline in cuticular thickness at the end of the summer may result from the effects of wind described so far and would thereby explain the fact that a similar decrease did not take place at the lowest, most sheltered site.

The results for the trees kept at Edinburgh showed a significant difference between the stations with much higher values in the two greenhouses compared to outside at

the end of the growth season. These values could reflect a compensatory increase in cuticle thickness as a prevention against excess water loss which might otherwise result from the high temperatures and comparatively dry conditions of the greenhouses. Cuticle thickness has long been thought to be related to the external environment. Lee and Priestley (1924), working on *Ribes* and *Prunus* spp., attributed cuticular changes to the chemical effects of light and heat on cuticular fats; increased fat mobility at higher temperatures resulting in the production of thicker cuticles. More recently, Baker (1974) found that maximum deposits of wax were formed on leaves of Brussels sprout (*Brassica oleracea* var. *gemmifera*) under conditions of high radiant energy or low humidity and that with respect to temperature a peak in wax production occurred at 21 °C. Extreme conditions such as high photon flux densities, low nutrient supply or wind supply, have been associated with thicker cuticles compared to those of the same species grown in less extreme environments (Juniper and Jeffree, 1983). A study on needle spectral reflectance in Canada has shown variation, especially within the blue and ultraviolet wave bands, to be attributable to the specific differences in the degree of complexity of the needle surface architecture, ie. in the structure and reflectance properties of the epicuticular waxes (Clark and Lister, 1975). These authors found comparatively high relative reflectance values for needles of Blue spruce (*Picea pungens* Engelm. var. *hoopsii*) and Colorado spruce (*Picea pungens* Engelm.) and related them to the plants' ability to tolerate high irradiation levels without damage and thereby survive under clear skies in the alpine environment within their natural range. With respect to altitude, however, no ultraviolet reflectivity correlations in a variety of alpine plant species could be established when leaves from several elevations on the east slope of the Colorado Front Range were compared (Caldwell, 1968). Although no significant differences in ultraviolet filtration capacity were found between plants growing at different altitudes, this capacity fluctuated in response to exposure to solar ultraviolet radiation, decreasing when plants were screened and increasing rapidly on sudden exposure.

In relation to the present work it could be suggested that the greenhouses represent the more extreme environment, in this case through elevated temperatures, restricted rooting and episodic water input. It may be possible that the plants at these stations produced thicker cuticles directly as a response to avoid desiccation, and that the 'leathery feel', mentioned earlier, could be attributed to relatively

large deposits of surface wax produced in response to the high temperatures. An alternative explanation is that cuticular development proceeds at a rate that depends on temperature, and that the first greenhouse happens to be at an optimal temperature for cuticular development.

As no relationship in cuticular thickness was found to exist with altitude the resulting implication is that the development of the cuticle is not closely dependent upon temperatures within the narrow range found at the field site in this year. The fully mature leaf surface of plants has been described as the product of the interaction between the environment and the genetic make-up of the plant (Juniper and Jeffree, 1983). Since genetic differences between the trees used in the present work were thought to have been minimised (all trees were of Dunkeld provenance) it may be considered that the absence of any trend with altitude was a true one.

The rejection of Tranquillini's hypothesis in respect to the present study is probably due to climatic differences between the two regions. The causes listed on the right side of the diagram (figure 3.3) are more characteristic of a continental alpine tree-line and generally more extreme than those experienced in Scotland. Although the severity of the Cairngorms' climate should not be underestimated factors such as snow-blast, high winter radiation and frozen soils have a much smaller influence on plant survival and occur less frequently than in the Austrian Central Alps. Incomplete development of cuticles, the first step to desiccation damage in this hypothesis, may be significant in regions where the onset and duration of the growing season is limited by temperature, but does not appear to occur at Creag Fhiaclach even though needle extension is completed here within four months. Having rejected the major part of this hypothesis it should be noted that the final link in the chain between critical water loss and desiccation damage may be applicable to all tree-line climates even though the causes leading to them differ.

## **(v) Conclusions**

- 1.** A 5% solution of chromic acid is suitable for isolation of intact *P. sylvestris* cuticles for determination of cuticular weight per surface area.
- 2.** Needle weight per surface area increases significantly with time but does not vary with altitude.
- 3.** Cuticle weight per surface area increases significantly with time in the early part of the growth season. The null hypothesis is accepted; the needle cuticles of *P. sylvestris* develop equally at all altitudes.
- 4.** Cuticle weight per surface area decreases at the end of the growth season at all altitudes. This may be attributable to some surface abrasion.
- 5.** The hypothesis proposed by Tranquillini (1979) of the causal relationships leading to desiccation of terminal shoots of trees in winter at the alpine tree-line is largely unapplicable to more oceanic climates such as that of Scotland.

## CHAPTER 4 : WATER AND NUTRIENTS.

### (i) Introduction

In the last two chapters suggestions have been made as to the factors contributing to the current position of the *Pinus sylvestris* tree-line at Creag Fhiaclach. So far, the influence of temperature on growth, and the development of the cuticles of the needle fascicles have been examined, the former being considered more important. In addition to temperature, variation may occur between different altitudes in the rate of water use and/or the amount of water that is available to the plants. In an attempt to assess the extent and significance of any such variation it was decided to determine water potentials of needles along an altitudinal transect throughout the growing season.

Two main relationships between water availability and altitude frequently occur in upland Britain. The first is that cloud cover and rainfall tend to increase with altitude whilst temperature decreases. This results in decreasing saturation vapour pressure and decreasing evaporation with elevation. Secondly, soils tend to be more shallow at higher elevations and therefore have a lower water storage capacity than deeper soils further down the same slope. Plants growing at higher altitudes may experience lower rates of evapotranspiration than those lower down but water supplies may become limiting during dry spells as a consequence of reduced water storage.

Wind is another important factor which varies with altitude and influences plant growth by affecting rates of evapotranspiration. Western and upland Britain form one of the windiest parts of the world, wind speeds increasing with altitude by 6 to 7 m s<sup>-1</sup> km<sup>-1</sup> (Grace and Unsworth, 1988). Wind affects heat and water exchange between plants and the surrounding atmosphere largely by reducing boundary layer resistances and thereby exerting cooling and drying effects. Although wind speeds are often greater at higher altitudes these effects may not increase linearly with elevation because the short stature of high altitude vegetation provides a relatively high aerodynamic resistance. Wind can also cause damage by force, such as breakage of branches and abrasion of needle surfaces, and in this way can contribute to water loss from the plant.

Prompted by the yellowing of needles on the potted plants in the valley (290 m) at Creag Fhiaclach, it was decided that the foliar nutrient content of the needles should be determined for both potted and native *P. sylvestris* along the altitudinal gradient. Although all potted trees were established in the same compost prior to being placed in the field, their different appearance led to the hypothesis that altitude may have some effect on the nutritional status of the trees.

As already mentioned in the general discussion of chapter 2 the greater frequency of cloud days at high altitudes may subject the plants growing there to larger chemical inputs than those at lower elevations. Hilltop vegetation may be exposed to comparatively high concentrations of nitrous oxides, sulphate and hydrogen ions from acid mist depositions which may contribute significantly to their overall nutrient content. Within the high rainfall areas of Cumbria, the Pennines, Wales and West Scotland inputs of atmospheric nitrogen have been estimated in the range of 12 to 20 kg N ha<sup>-1</sup> y<sup>-1</sup> (Pitcairn *et al.*, 1991). Rates of deposition of atmospheric pollutants from cloud-water have been found to vary with the height of the vegetation; higher rates occurring in forested areas where the surface for interception is larger, than in regions of shorter plants (Unsworth and Crossley, 1987). This source of nitrogen may be particularly important at high altitudes where poor, shallow soils tend to be low in nutrients and can be limiting to growth. An additional atmospheric input at high elevations, only recently recognised, is ozone. Evidence for this comes from studies at Great Dun Fell in the Pennines, England (Fowler *et al.*, 1989). Ozone is a strong oxidising agent and may disrupt metabolic processes in plants.

The null hypotheses for these two investigations were as follows;

$H_0$  : The needle water potential of *Pinus sylvestris* is equal at all altitudes.

$H_0$  : The nutrient concentrations of needle fascicles of *P. sylvestris* are equal at all altitudes.

Water potential determination was carried out in the laboratory by means of a pressure chamber, using excised needles (Scholander *et al.*, 1965).

Nutritional analysis was carried out on the same samples. Analysis for the macronutrients nitrogen (N), phosphorus (P), potassium (K), calcium (Ca) and magnesium (Mg) were carried out. These nutrients were considered to be important as they are present in rainwater and are frequently contained in agricultural fertilisers in a variety of forms, both of these sources being likely to influence the foliar concentration of needles of trees on upland sites. Forest decline, such as that observed since the 1970s in spruce in West Germany, has been correlated with magnesium deficiencies, magnesium-deficient needles being associated with a breakdown in the basic physiology of the tree (Innes, 1987).

## **(ii) Materials and methods**

Needle fascicles were sampled from the native *P. sylvestris* trees and from all potted trees at Creag Fhiaclach at intervals during 1990 for determination of water potential. Two individual fascicles were excised, as close to midday as possible, from the mid-length of a current year lateral shoot from five potted trees per station and from five native trees per station. In the case of the February, April and May measurements the current year fascicles were those produced in the growth season of 1989, whereas for June, July and August they were those produced in 1990. The term "current year" in this chapter therefore refers to the youngest needles present at the time of measurement.

Fascicles were detached from the shoot at the base using a sharp blade, and samples from each station were immediately wrapped tightly in aluminium foil and placed into a small plastic specimen jar containing a piece of moistened cloth. Water potentials were determined as soon as possible on the following day in the laboratory using a customised pressure bomb (Scholander *et al.*, 1965) with a small chamber specifically designed for use with conifer needles. Needle fascicles were placed individually into the chamber and a tight seal was made before any readings were taken. Compressed nitrogen gas was slowly admitted to the chamber whilst the excised end was viewed under a binocular microscope. Readings were taken at the point at which liquid first appeared at the cut surface. Water potentials were

determined on a per station basis for the potted and native trees at each station at four-weekly intervals on the following dates;

- 5 April
- 2 May
- 24 May
- 29 June
- 27 July
- 28 August.

In addition to this the water potentials of the potted trees were determined in early February using needles produced in 1989.

Further samples from native trees at the field site were taken in conjunction with measurements of photosynthesis (described in chapter 5) and analysed in a similar way. Both current year (n) and previous year (n-1) shoots were sampled from each of twelve trees growing at two separate locations; one above the tree-line (590 m) and one in the valley below (290 m). Sampling was carried out in late June and again in early September, and for the year n shoots a third sample was made in late November.

Chemical analysis was carried out in the Departmental chemical laboratories by Mr. Andrew Gray for percentage content N and P by means of a flow injection analyser (Tecator Fiastar, Bristol, England) and for percentage content K, Ca and Mg by atomic absorption spectrophotometry (atomic absorption spectrophotometer, Pye Unicam SP9, Cambridge, England) on all samples after their water potentials had been determined. Each sample was oven-dried at 80 °C overnight and allowed to cool in a desiccator. Dried material was ground and 0.1 g was weighed accurately (to 4 decimal places) into a dry test-tube. 2 cm<sup>3</sup> concentrated sulphuric acid was added and then 2 cm<sup>3</sup> hydrogen peroxide. The tube was heated at 340 °C for 6 hours after which time all organic matter had been broken down to give a clean solution. When cool the contents were transferred to 50 cm<sup>3</sup> and adjusted to volume with distilled water.

Percentage content of N was determined by means of a gas exchange system across a membrane using a colour indicator. For P an ammonium molybdate/stannous

chloride reaction was used. Percentage content of K was determined using an atomic absorption spectrophotometer in the emission mode, and for Ca and Mg the same instrument was used in the absorption mode with the addition of 0.1% lanthanum solution as a releasing agent.

All values were multiplied by 10 and results were expressed as concentrations ( $\text{mg g}^{-1}$ ).

### (iii) Results

#### *Needle water potential*

Values of mean needle water potential for the native and potted trees at Creag Fhiaclach are shown in tables 4.1 and 4.2, respectively. For the native trees mean needle water potentials ranged between -0.05 MPa at 290 m in late June to -1.69 MPa at 580 m in late August (table 4.1). The overall trend was a decrease in water potential in April, an increase in May and June followed by a second decrease in July and August.

Mean needle water potentials ranged between -0.07 MPa at 580 m in late June and -2.08 MPa at 675 m in early May for the potted trees (table 4.2). A general pattern was observed at all stations comparable to that shown by the native trees in which potentials became more negative between February and May, were less negative in late June and then decreased (became more negative) again in July and August.

Plots of mean needle water potential against time for all trees are shown in figure 4.1. The results for the native trees show a very distinct trend with time which is similar at all altitudes. Mean water potentials in early April were between -0.5 and -1.0 MPa and became more negative in early May by approximately 0.5 MPa at each station. By late May values were much less negative, approaching zero (-0.05 to -0.09 MPa) in all cases, and remained fairly steady throughout June and July. By late August water potentials were more negative again, values being similar to those of early May. Throughout the season no clear trend with altitude was apparent although some grouping between stations was shown in late August. At this time, the trees at the tree-line stations had the most negative potentials, those at the highest station had the least negative and those at the two lowest had values halfway between. 95 % confidence intervals overlap within any one date indicating variation with altitude was not significant. For clarity most error bars are omitted, but those drawn do show some significant differences between altitudes with time.

**Table 4.1** : Mean needle water potentials with standard errors for current year needles of native *P. sylvestris* at Creag Fhaiclach in 1990, (MPa). n=5.

Date	Altitude (m)				
	290	450	570	580	675
April 5	-0.89	-0.49		-0.70	-0.79
s.e.	0.19	0.06		0.11	0.15
May 2	-1.37	-1.01	-1.58	-1.18	-1.38
s.e.	0.24	0.21	0.03	0.22	0.12
May 24	-0.06	-0.07	-0.10	-0.13	-0.17
s.e.	0.03	0.12	0.15	0.07	0.36
Jun 29	-0.05	-0.10	-0.06	-0.09	-0.06
s.e.	0.00	0.03	0.33	0.05	0.10
Jul 27	-0.13	-0.20	-0.11	-0.14	-0.08
s.e.	0.04	0.35	0.06	0.09	0.16
August 28	-1.34	-1.42	-1.68	-1.69	-1.02
s.e.	0.14	0.20	0.17	0.19	0.11

**Table 4.2 :** Mean needle water potentials with standard errors for current year needles of potted *P. sylvestris* at Creag Fhiaclach in 1990, (MPa). n=5.

Date	Altitude (m)				
	290	450	570	580	675
February 9	-0.08	-0.32	-0.62	-0.4	-0.34
s.e.	0.15	0.06	0.12	0.10	0.02
April 5	-1.03	-1.07		-1.12	-1.47
s.e.	0.16	0.64		0.55	0.59
May 2	-1.57	-0.95	-1.44	-1.27	-2.08
s.e.	0.34	0.19	0.16	0.21	0.20
May 24	-1.59	-1.48	-0.15	-1.35	-1.42
s.e.	0.12	0.24	0.18	0.21	0.23
June 29	-0.9	-0.65	-0.35	-0.07	-0.85
s.e.	0.20	0.05	0.05	0.18	0.15
July 27	-1.25		-0.68	-0.9	-1.01
s.e.	0.38		0.04	0.09	0.05
August 28	-0.75		-1.56	-1.51	-1.14
s.e.	0.08		0.09	0.21	0.35

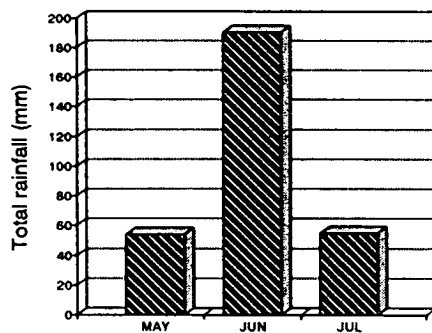
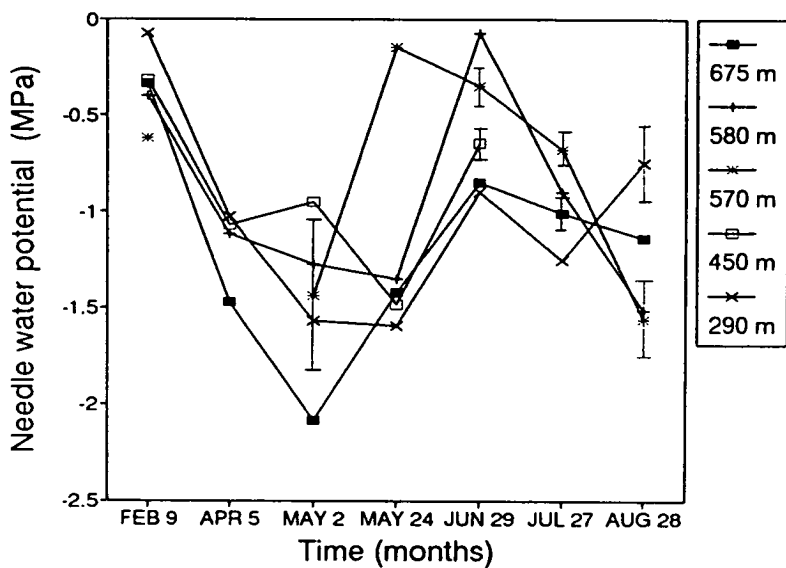
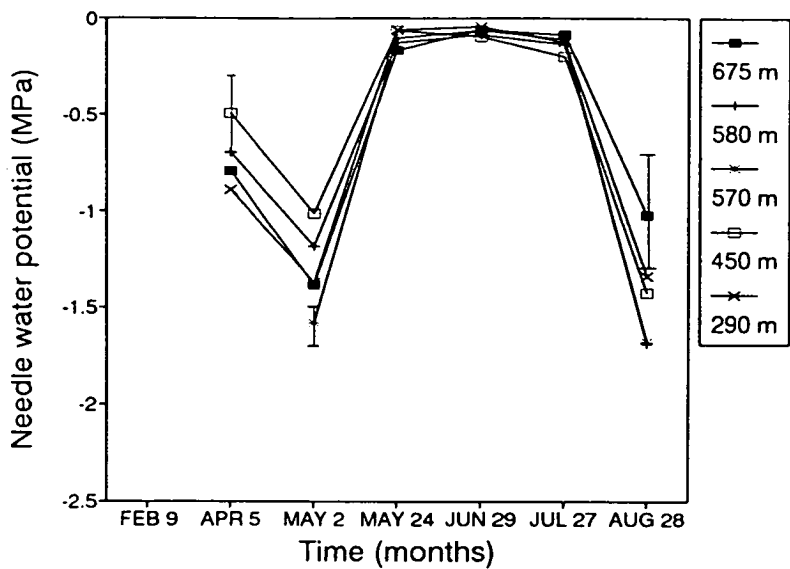

**Figure 4.1 :** Mean needle water potentials for native (upper) and potted (lower) *P. sylvestris* at Creag Fhiaclach, 1990. Error bars are 95 % confidence intervals. Bar chart shows total monthly rainfall distribution (mm) for Cairngorm Chairlift weather station.

The total rainfall was over 50 mm in each month of the main growth season (May, June and July). The highest total was for June (190.2 mm) which was cool, cloudy and wet and corresponds with the peak observed in needle water potential for all trees i.e. where water potentials were less negative. (No rainfall data were available for February at this weather station).

The potted trees show far more variation both between stations and over time. However, a trough is also apparent early in the season where potentials became more negative and a peak in June of less negative values also occurred and was followed by a second decrease. Mean values early in the season were most negative at the highest station (675 m) being up to 0.5 MPa lower than those at any other in early May. At the tree-line stations water potentials were the least negative of those measured from late May to late July but by the end of August were more negative than at any other station. The error bars indicate that the potentials just below the tree-line (570 m) varied significantly within the season and also between this station and some others (eg. 450 m on June 29th).

### *Needle nutrient concentrations*

An idea of whether plants have adequate nutrition may be obtained from the ratio of N:P:K present. The nutrient balance should approximate to 10:1:5 for normal growth. This ratio was compared with the results of the current study and used to identify low concentrations of nitrogen, phosphorus and potassium.

Tables 4.3 and 4.4 show the nutrient concentrations of the needles of native and potted trees, respectively. For the native trees nitrogen was between 8.7 and 15.0 mg g<sup>-1</sup>, and showed a decrease with increasing altitude in early February. Potassium and calcium were present in much smaller quantities than nitrogen, ranging from 1.74 to 5.50 mg g<sup>-1</sup> (K), and 2.28 to 4.97 mg g<sup>-1</sup> (Ca). Magnesium was present in the lowest concentrations (0.67 to 1.21 mg g<sup>-1</sup>) being slightly lower than those of phosphorus (0.85 to 1.40 mg g<sup>-1</sup>) in almost every case.

Concentrations of N appeared to be low in the clearing (450 m) and just below the tree-line (570 m) at the end of May. Some low values were also observed on

**Table 4.3 :** Nutrient content of current year needles of native *P. sylvestris* from Creag Fhiachlach in 1990 (mg g<sup>-1</sup>).  
b indicates a nutrient imbalance from an N:P:K ratio of 10:1:5.

Nutrient	Date	Altitude (m)				
		290	450	570	580	675
Nitrogen	Feb 9	15.0	11.3	10.5 b	8.7 b	
	Apr 5	13.4	11.8	11.4		12.0
	May 2	12.9	10.7	12.5	12.0	13.0
	May 24	11.1	10.0 b	9.8 b	11.7	11.8
Phosphorus	Feb 9	1.40	1.13 b	1.21	1.21	
	Apr 5	1.29	1.39	1.04		1.12
	May 2	1.28	1.18	1.02	1.02	1.02
	May 24	1.07	1.08	0.85	0.99	1.12
Potassium	Feb 9	5.50	5.00	2.90 b	3.50 b	
	Apr 5	4.33 b	4.37 b	4.52	4.82	1.74 b
	May 2	4.48 b	4.08 b	4.23 b	4.01 b	3.58
	May 24	3.69 b	3.52 b	2.73 b	3.46 b	3.44 b
Calcium	Feb 9	4.14	2.40	2.45	3.36	
	Apr 5	2.38	2.87	2.72		3.32
	May 2	3.16	2.28	3.21	2.51	4.97
	May 24	3.45	3.86	2.78	3.07	3.18
Magnesium	Feb 9	1.07	1.21	0.71	1.03	
	Apr 5	0.95	1.14	0.97		0.95
	May 2	1.03	1.03	0.95	0.96	0.67
	May 24	0.79	0.97	0.96	0.85	0.81

**Table 4.4 :** Nutrient content of current year needles of potted *P. sylvestris* from Creag Fhiaclach in 1990 (mg g<sup>-1</sup>).  
b indicates a nutrient imbalance from an N:P:K ratio of 10:1:5.

Nutrient	Date	Altitude (m)				
		290	450	570	580	675
Nitrogen	Feb 9	11.30	9.90	7.70 b	9.10 b	7.40 d
	Apr 5	9.70	9.10 b	9.30 b	8.20	10.30 d
	May 2	11.10	7.30 b	7.90 b	7.70 b	8.70 d
	May 24	7.10 b	4.90 b	6.00 b	7.90 b	8.10 d
Phosphorus	Feb 9	1.46	1.70	1.53	1.63	1.66
	Apr 5	1.74	1.45	2.12	1.70	1.49
	May 2	1.64	1.43	1.72	1.58	1.49
	May 24	1.29	0.97	1.15	1.34	1.51
Potassium	Feb 9	5.50	7.50	6.80	7.10	6.90
	Apr 5	4.39	6.41	5.53	6.84	5.45
	May 2	4.04	4.98	5.91	7.05	5.63
	May 24	6.39	4.11	5.08	5.91	6.28
Calcium	Feb 9	1.21	1.77	1.61	1.49	1.61
	Apr 5		1.20		0.45	0.42
	May 2		0.10	0.05	0.31	0.48
	May 24		0.12	0.39	0.82	0.87
Magnesium	Feb 9	1.16	1.66	1.47	1.47	1.41
	Apr 5	1.78	1.48	2.03	1.56	1.45
	May 2	1.51	1.32	1.34	1.32	1.29
	May 24	1.34	1.29	1.13	1.15	1.32

either side of the tree-line (570 m and 580 m) in February. Low concentrations of K were noted at all stations but especially at 570 m and 675 m.

The needles of the potted trees had lower nitrogen concentrations at each station and at each time of measurement than the native trees, most values being below 10 in the ratio 10:1:5. The exception to this was in the valley where N values were not low until the end of May. Concentrations of phosphorus, potassium and magnesium were generally higher, K particularly so at 450 m and 570 m. The calcium concentrations of the needles of the potted trees were much lower than those for the native trees, being between 0.05 and 1.77 mg g<sup>-1</sup>, with some values as much as ten times smaller. Lowest concentrations were present in May at 450 m and 570 m.

No clear trend was apparent with time or altitude for either group of trees.

Figures 4.2 to 4.5 show plots of nutrient concentrations against altitude for the individual measurement dates and provide a view of the relationships between the nutrients at a given time and their variation with altitude. The results for early February (figure 4.2) show very little difference between phosphorus and magnesium, and in the case of the potted trees also for calcium. The clearest decline with increasing altitude was for nitrogen for all trees with a distinct change on either side of the tree-line. For the native trees this change was a further decrease, but for the potted trees the nitrogen concentration was larger at the higher station (580 m). A similar difference with greater values immediately above the tree-line occurred for potassium and magnesium in all trees and for calcium in the native trees. After regression analysis the relationship with altitude was significant only for nitrogen in the native ( $P=0.05$ ) and potted ( $P=0.02$ ) trees. (In the native trees potassium decreased significantly with increasing altitude at the 10 % level ( $P=0.1$ )).

In early April nutrient concentrations generally followed similar patterns to those seen in February although calcium levels in the potted trees had decreased noticeably (figure 4.3). No significant relationships were found with altitude for either group of trees.

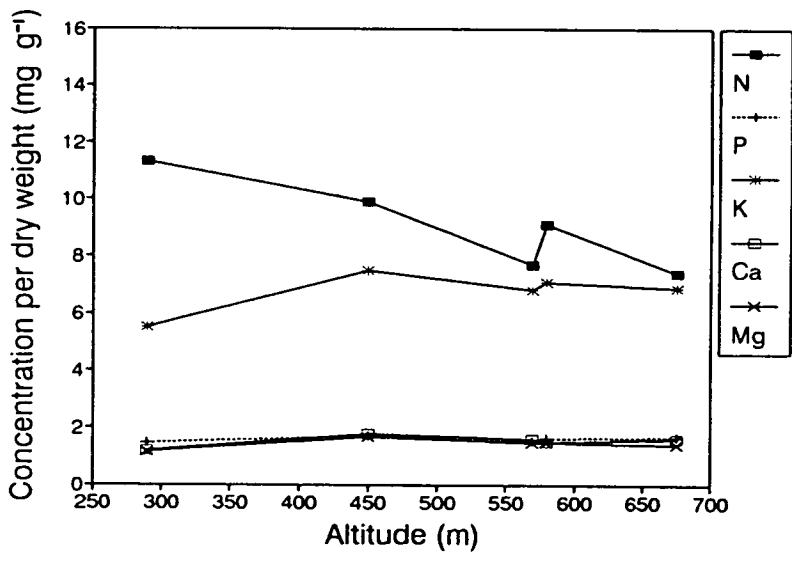
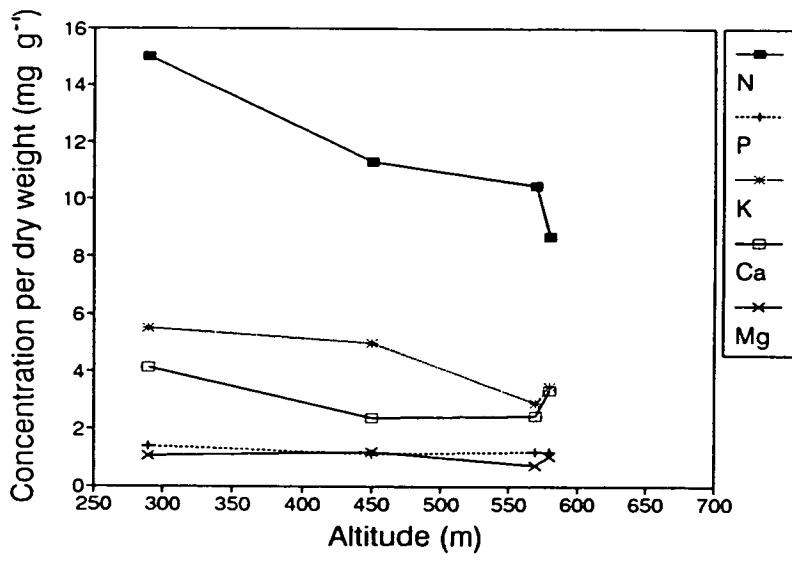

**Figure 4.2 :** Relationship between mean nutrient concentrations and altitude for needles of native (upper) and potted (lower) *P. sylvestris* at Creag Fhiaclach on 9th February 1990.

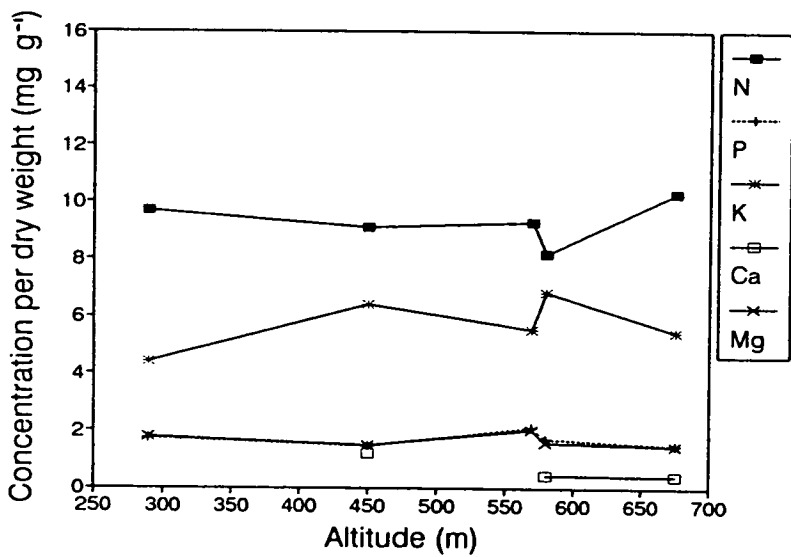
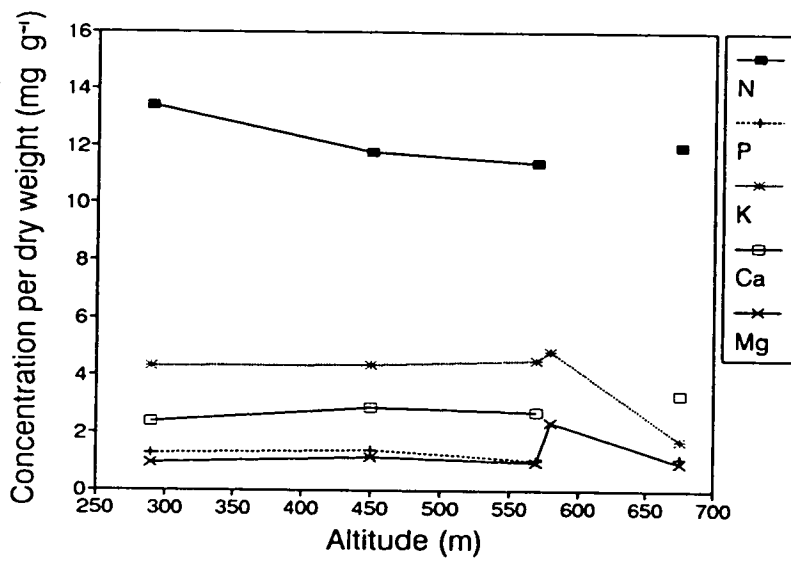

**Figure 4.3 :** Relationship between mean nutrient concentrations and altitude for needles of native (upper) and potted (lower) *P. sylvestris* at Creag Fhiaclach on 5th April 1990.

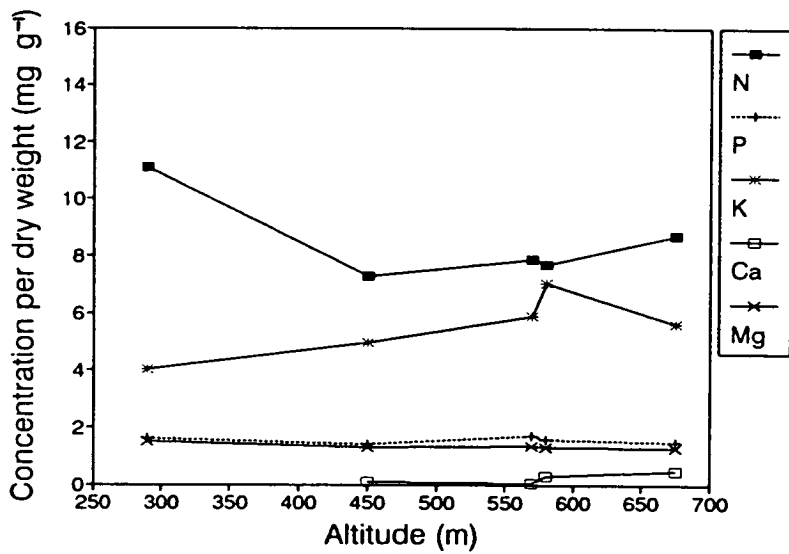
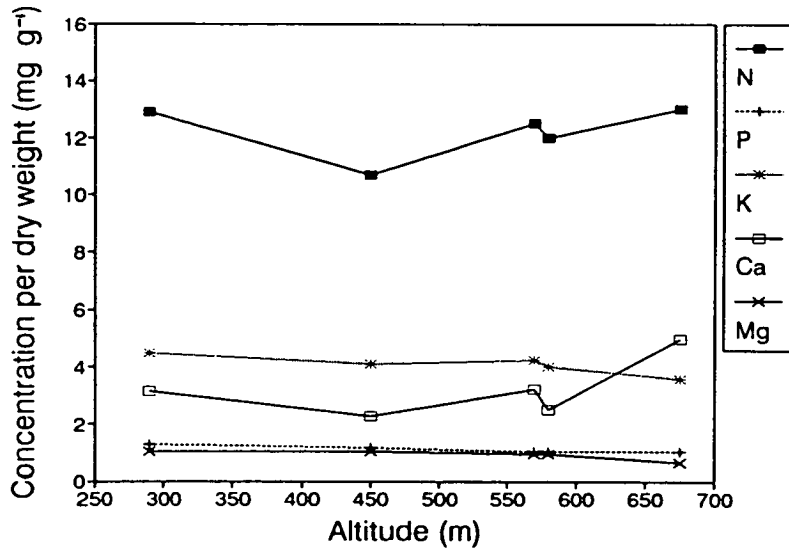

**Figure 4.4 :** Relationship between mean nutrient concentrations and altitude for needles of native (upper) and potted (lower) *P. sylvestris* at Creag Fhiaclach 2nd May 1990.

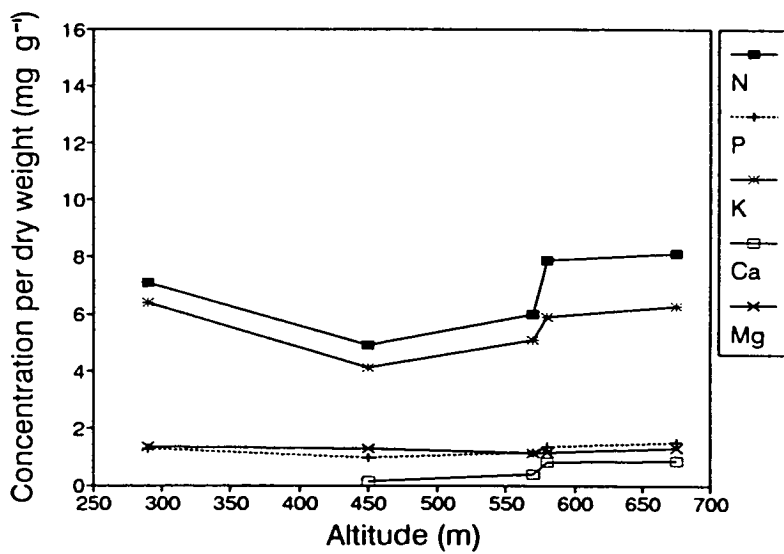
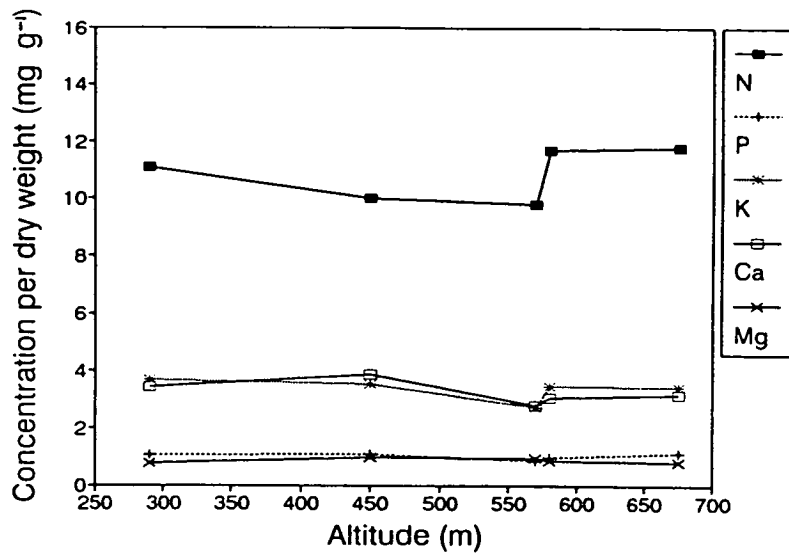

**Figure 4.5 :** Relationship between mean nutrient concentrations and altitude for needles of native (upper) and potted (lower) *P. sylvestris* at Creag Fhiaclach, 24th May 1990.

Figure 4.4 shows the results for early May. Nitrogen increased with altitude above 290 m although was not significant over the whole transect in either the native or potted trees. Phosphorus decreased significantly with increasing altitude ( $P=0.01$ ) in the native trees, and to a lesser extent potassium also ( $P=0.1$ ). For the potted trees magnesium was the only nutrient significantly related with altitude ( $P=0.05$ ). Clear changes in nutrient concentrations either side of the tree-line were still apparent in all trees.

By late May (figure 4.5) the nitrogen concentration of the potted trees had decreased since the previous measurement particularly at the lower stations and the change at the tree-line was larger, values being higher at 580 m than at 570 m for both tree groups. Calcium and potassium values for the native trees were very similar at the time in May, potassium values having been distinctly higher in all previous measurements. The only significant relationship with altitude was for calcium in the potted trees ( $P=0.05$ ) which increased with increasing altitude.

The nutrient concentrations of the needles that were collected from young native trees in conjunction with the photosynthesis measurements are shown in table 4.5. All nutrient concentrations decreased between June and September in current (n) and one year-old (n-1) needles of both populations. Nitrogen concentration was greater above the tree-line than in the valley in the younger needles but for most other nutrients the concentrations were less variable between the two areas and often higher in the valley. An exception to this was calcium which was distinctly lower above the tree-line for both age groups in September and for the year n needles in November. Nitrogen values were low in the year n needles of the valley trees in September and November. Both populations had low P concentrations in November. No notably low values of K, Ca or Mg were noted at any time in any of the trees.

Figures 4.6 to 4.10 show the plots of each nutrient individually for both needle ages and for both sampling areas (tree-line and valley) against time. A three-way analysis of variance was carried out on the June and September data for each nutrient.

Nitrogen concentration of needles showed the greatest variation between June and September, decreasing with time (figure 4.6). There was also a large difference

**Table 4.5 :** Mean nutrient content of current (n) and previous year (n-1) *P. sylvestris* needles from a population of native trees above the tree-line and in the valley below, at Creag Fhiaclach, 1990 (mg g<sup>-1</sup>). Standard errors shown in brackets. b indicates a nutrient imbalance from an N:P:K ratio of 10:1:5.

Nutrient			June		September		November	
Nitrogen	Tree-line	n	20.9	(1.30)	11.8	(0.80)	11.4	(0.50)
		n-1	13.6	(0.90)	11.8	(0.80)		
	Valley	n	19.7	(1.00)	8.3	(0.60) b	10.6	(0.50)
		n-1	13.7	(0.60)	10.5	(0.30)		
Phosphorus	Tree-line	n	2.3	(0.10)	1.1	(0.03)	0.4	(0.01) b
		n-1	0.9	(0.30)	0.8	(0.06)		
	Valley	n	2.6	(0.20)	1.1	(0.03)	0.4	(0.01) b
		n-1	1.3	(0.04)	1.0	(0.03)		
Potassium	Tree-line	n	7.8	(0.50) b	5.3	(0.40)	5.0	(0.02)
		n-1	4.8	(0.30) b	4.2	(0.30) b		
	Valley	n	8.7	(0.30)	5.4	(0.20)	5.5	(0.02)
		n-1	5.5	(0.30)	4.5	(0.30)		
Calcium	Tree-line	n	4.5	(0.50)	1.5	(0.10)	2.1	(0.19)
		n-1	3.6	(0.20)	2.7	(0.20)		
	Valley	n	3.2	(0.20)	2.1	(0.20)	3.0	(0.20)
		n-1	4.7	(0.30)	4.7	(0.30)		
Magnesium	Tree-line	n	1.3	(0.06)	0.8	(0.03)	0.8	(0.07)
		n-1	1.0	(0.06)	0.8	(0.06)		
	Valley	n	1.2	(0.10)	1.0	(0.03)	1.2	(0.01)
		n-1	1.1	(0.10)	0.9	(0.01)		

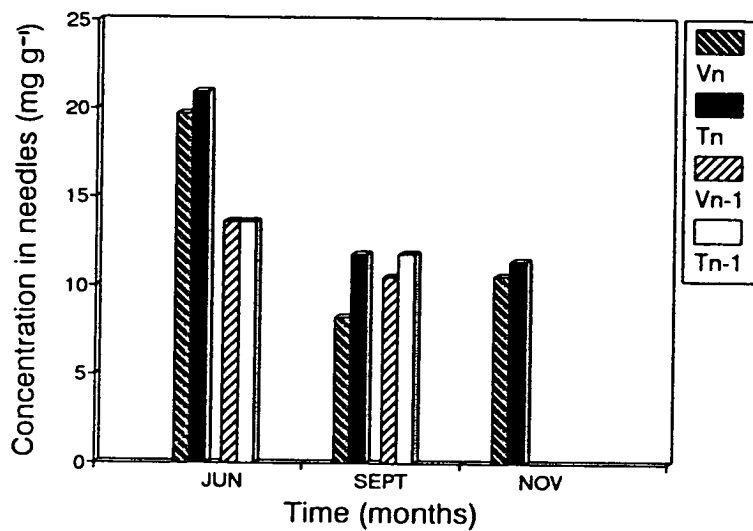

**Figure 4.6 :** Nitrogen concentration of *P. sylvestris* needles from a native population above the tree-line (T) and from the valley (V) in three months of 1990. Current year needles (n) and one year-old needles (n-1) are plotted separately.

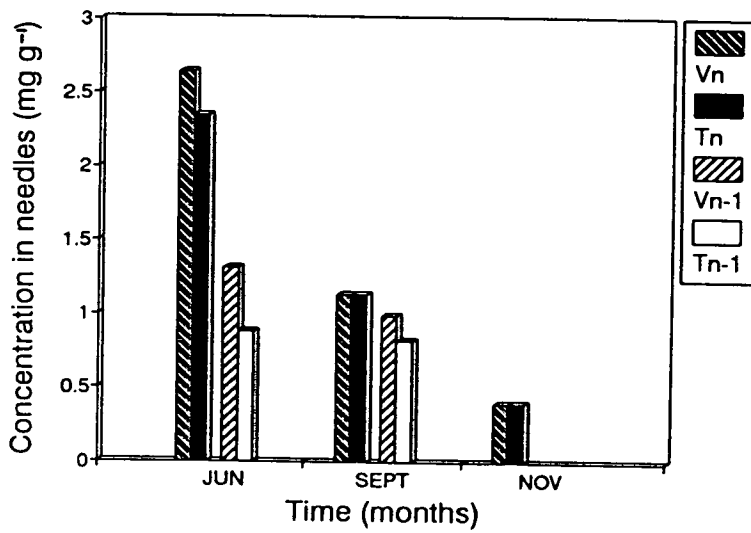

**Figure 4.7 :** Phosphorus concentration of *P. sylvestris* needles from a native population above the tree-line (T) and from the valley (V) in three months of 1990. Current year needles (n) and one year-old needles (n-1) are plotted separately.

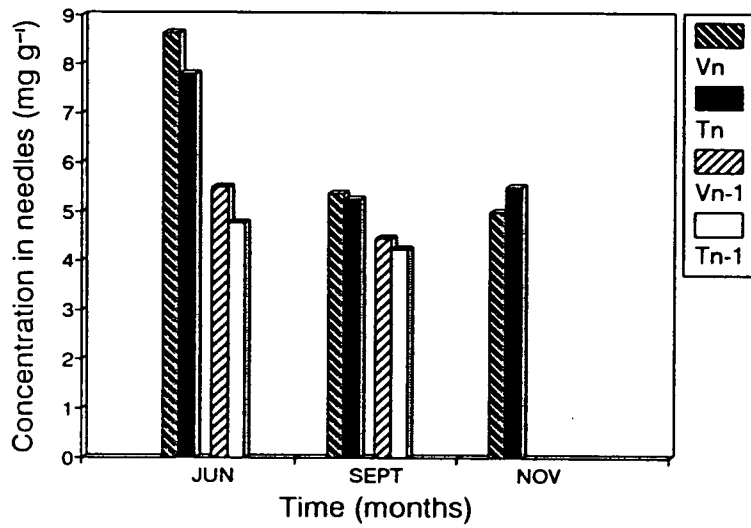

**Figure 4.8 :** Potassium concentration of *P. sylvestris* needles from a native population above the tree-line (T) and from the valley (V) in three months of 1990. Current year needles (n) and one year-old needles (n-1) are plotted separately.

between the two age groups in June when younger needles (n) had a higher nitrogen concentration. Nitrogen was found to vary significantly with time and with needle age ( $P=0.0001$ ). Variation with altitude was also significant although to a lesser extent ( $P=0.01$ ), in most cases nitrogen concentrations being higher above the tree-line than in the valley.

Figure 4.7 shows the results for needle phosphorus concentration and, as for nitrogen, one of the largest differences occurred between the needle age groups in June, with younger needles having higher values. The year n needles showed a large drop in phosphorus concentration between each time of measurement. In contrast to the N results, P concentrations were higher in the valley trees in most cases. Values were found to vary significantly with time and age ( $P=0.0001$ ) and to a lesser extent with altitude ( $P=0.001$ ).

The potassium concentrations of needles (figure 4.8) showed a similar overall pattern to that of phosphorus with the exception that the values for the younger needles did not decrease between September and November but were approximately equal in these two months. Variation with time and needle age was highly significant ( $P=0.0001$ ), variation with altitude was significant at the 5% level ( $P=0.05$ ).

Figure 4.9 shows the results for calcium concentrations. A smaller difference was shown between the needle age groups in June than for the plots for other nutrients although variation between altitudes was greater at this time. Calcium concentration decreased from June to September in the year n needles but remained relatively high in the n-1 needles. A large difference was shown in September with older needles (n-1) having much higher calcium concentrations. In most cases values were higher for the valley trees than for those above the tree-line. Variation was significant with time and needle age ( $P=0.0001$ ), and to a lesser extent with altitude ( $P=0.01$ ).

Magnesium concentrations (figure 4.10) were also quite variable and values decreased between June and September in all cases. Needles from the valley trees had higher concentrations than those from above the tree-line within age groups with the exception of the year n needles in June. Variation was found to be significant with time and needle age ( $P=0.0001$ ), and also with altitude ( $P=0.01$ ).

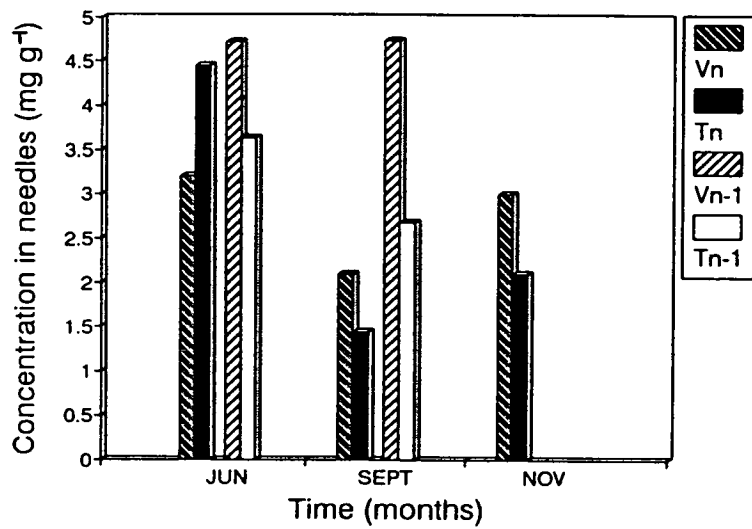

**Figure 4.9 :** Calcium concentration of *P. sylvestris* needles from a native population above the tree-line (T) and from the valley (V) in three months of 1990. Current year needles (n) and one year-old needles (n-1) are plotted separately.

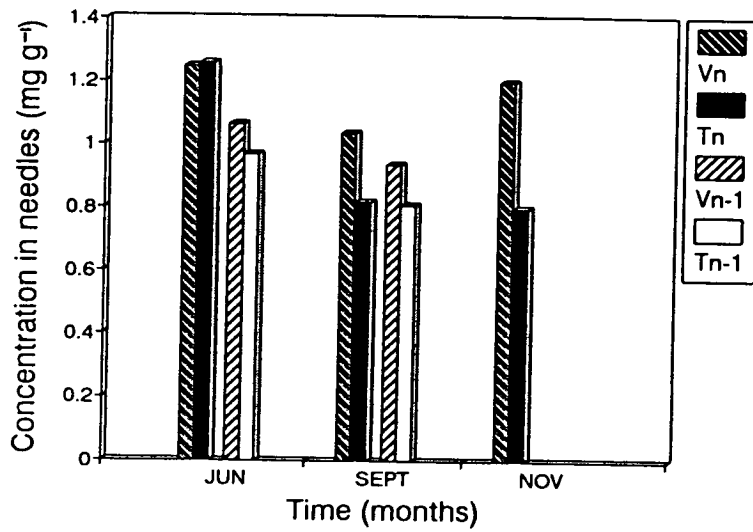

**Figure 4.10 :** Magnesium concentration of *P. sylvestris* needles from a native population above the tree-line (T) and from the valley (V) in three months of 1990. Current year needles (n) and one year-old needles (n-1) are plotted separately.

Within the analysis for each nutrient, tests for interactions were included as part of the three-way ANOVA. Interactions between needle age and month were highly significant ( $P=0.0001$ ) for nitrogen, phosphorus and potassium, and also for calcium ( $P=0.0002$ ). For phosphorus and calcium the interaction between altitude and month was also significant ( $P=0.03$  and  $P=0.001$ , respectively). Overall, the highest number of significant interactions was found for calcium where each combination of two of the three variables was significant, although the test for all three together was not. At the other end of the scale was magnesium which showed no significant interactions for any of the combinations.

For all nutrients measured the only increase with time within any of the four groups occurred between September and November. For nitrogen and magnesium the increase was in the young needles of the valley trees (Vn), for potassium it occurred in the young tree-line needles (Tn) and for calcium an increase was seen in both of these groups.

#### (iv) Discussion

##### *Water potential*

Water potential is the difference in chemical potential of water at any point in a system and that of pure water at the same temperature and atmospheric pressure (Sutcliffe, 1979). In most biological systems water has less potential energy than pure water and therefore values are usually negative. Water moves along a concentration gradient from regions of less negative to more negative potentials. Although water potential is often divided into three main components (matric, osmotic and pressure potential) no attempt to do so was made in this study. In the present work water potentials were measured in megapascals (MPa). These are units of pressure which are dimensionally equivalent to energy per unit volume (Tyree and Karamanos, 1981). Water is essential to plant growth and has a variety of functions. Kramer (1962) grouped <sup>these</sup> under four main headings; maintenance of cell turgidity, photosynthetic reagent, primary solvent and the principal constituent of protoplasm. Tree growth is reduced by water deficits both directly and indirectly through these functions. Water deficits in the tissues of plants may arise when the balance between water absorbed and water lost becomes disrupted. Such a disruption may be due to excessive loss, for example through transpiration or as a result of tissue damage, or to relatively slow uptake and absorption of water from the soil, for example when soil water is frozen, cold, or in short supply. Atmospheric water vapour deficit determines the potential rate of water loss from the plant. The actual loss is influenced by stomatal conductance which varies with the age of leaves, their position on the plant and in the canopy, and also with the season, time of day and both recent and current weather (Jarvis, 1981).

With respect to altitude a general division can be made between atmospheric demand and factors reducing water uptake. Körner and Mayr (1981) investigated leaf diffusive conductance, water potential and anatomy for 37 species between 600 and 2,600 m in the Austrian Central Alps. They found maximum leaf diffusive conductance to increase with increasing altitude except in very exposed communities in summit habitats. Also leaf water potentials in herbaceous and woody species were observed to increase slightly with altitude. Often the factors

contributing to water deficits involve a combination rather than a single cause and therefore may not be easily identified.

In the present work the effects of low temperatures were considered to be the most likely causes of water deficits. Low temperatures can reduce uptake rates by roots by slowing chemical reactions in metabolic processes and thereby slowing root growth. They can also exert effects on the physical properties of water causing an increase in viscosity or freezing to occur and thereby restricting the amount of soil water available to the plant. Soil water potential at the root-soil interface is a key factor controlling the availability of soil water to plants and under conditions where soil water potential and hydraulic conductivity are low, the concentration gradient necessary to maintain flow will increase and may cause critical values of root water potential to develop (Slatyer, 1967). Another possible effect of low temperatures is freezing damage to plant cells and surfaces although prolonged freezing is less frequent at this site than at other tree-lines in western Europe and in Scandinavia. A more likely cause of tissue damage here is that caused by the impaction of wind-blown particles and the abrasion of surfaces brought in contact during plant movement in wind as described by van Gardingen *et al.* (1991) and mentioned in the previous two chapters.

The most direct climatic effect, apart from temperature, which may cause variation in water potentials of trees along an altitudinal transect is precipitation, the amount and duration of which may vary between stations. Rainfall and cloud moisture are likely to increase with altitude in oceanic climates resulting in lower evaporative demands and therefore reduced water loss from plants at higher elevations. In more continental regions where tree-lines occur at much higher altitudes the protective effect of snow may be more important in maintaining water balance. A comparative study of two areas by McCracken *et al.* (1984) showed desiccation to be a major problem for mountain beech (*Nothofagus solandri* var. *cliffortioides*) seedlings growing at 1,370 m in the Craigieburn Forest Park in New Zealand where the dense snow pack seldom exceeds 0.5 m in depth. In contrast, seedlings of cembra pine (*Pinus cembra*) at Stillberg in Switzerland survived at altitudes between 1,800 and 2,200m largely due to the protective snow cover, 1.3 to 1.5 m in depth, which lies for approximately 130 days longer than that at the New Zealand timberline.

An idea of the rate of change with altitude can be gained from estimates of climatic factors for different elevations such as those given by Körner and Mayr (1981) for the Austrian Central Alps. From the data presented by these authors values of the annual sum of evapotranspiration, annual average of vapour pressure and the July maximum vapour pressure deficit would give rates of  $150 \text{ mm km}^{-1}$ ,  $0.6 \text{ MPa km}^{-1}$  and  $0.2 \text{ MPa km}^{-1}$ , respectively, all factors decreasing with increasing altitude.

All trees measured in the present study showed more negative needle water potentials at the start and end of the main growth period (early May and late August), and less negative values in the early part of the year and throughout the main growth phase. Stomatal closure has been found to occur in Scots pine seedlings at a needle water potential of  $-1.5 \text{ MPa}$  (Jarvis and Jarvis, 1963). In the current work needles with values below  $-1.4 \text{ MPa}$  were considered to have significant water stress and thereby only those values observed over April and May and in late August are regarded as indicative of stress. This pattern can be related to the amount of rainfall over these months by reference to meteorological data for Aviemore and the Cairngorm Chairlift (the two closest meteorological stations). Across the period from April to August, April and June were wetter months (April;  $59.9 \text{ mm}$  - Aviemore. June;  $133.3 \text{ mm}$  - Aviemore,  $190.2 \text{ mm}$  - Cairngorm Chairlift). Rainfall was low on and prior to the measurement days in May, July and August. From this it can be seen that the more negative values of needle water potential occurred in the relatively dry periods of May and August. However, the relationship is not a simple one since less negative values were found in late May (dry), June (wet) and July (dry). The results for the native trees suggest that no water deficits occurred throughout the main period of needle extension and therefore that needle elongation was unlikely to have been limited by water availability.

In general *Pinus* spp. have a relatively high resistance to water loss when compared with other species largely as a result of highly cutinised leaf surfaces and sunken stomata both of which contribute to a high diffusion resistance (Kaufmann, 1968). The more variable results for the potted trees can be attributed to their comparatively young age and small size and to the fact that their root growth may have been more restricted than that of the naturally occurring plants at this site. The relatively small stature of the potted trees means that the potential for internal water storage is much less than that for the larger native trees which means that the

potted trees are likely to be more susceptible to fluctuations in water availability. This effect may be emphasised by the more vigorous growth of the younger trees. The restriction inflicted on root growth by the pots was such that lateral extension was not possible without first growing to a depth below that of the open base of the pot. As a result, the plants would only have had access to soil water in the immediate region of their main stem whereas the roots of the larger, native trees may have covered a substantial area of soil. A restriction on lateral root growth may be of significance at this site where shallow, peaty soil over a granite substrate provides relatively little rooting depth. The root area of the potted trees was observed to have been fairly small and mainly still contained within the region of the pots when the plants were removed from the site at the end of the second winter. A small root area combined with small plant size also implies that the internal water storage capacity is fairly low and therefore that the water balance of the whole plant can become disrupted easily.

The variation in needle water potential between altitudes was far more marked in the potted than the native trees. Although a lag exists between transpiration and uptake related to internal water storage (Waring and Running, 1976) and trees tend to become increasingly dehydrated during the day as a result, this effect is more common in large trees and it cannot be concluded that this was the single cause of altitudinal variation in the present work. Even though the distances between stations along the transect were such that several hours elapsed between the first and last sample collections a similar pattern was not shown by the native trees and neither was the relative position of the stations the same in all plots even though the samples were collected in the same altitudinal order on each occasion.

### *Nutrient concentrations*

An element is classed as being essential to a plant if the plant is unable to complete its normal life cycle without it and if no other element can substitute for it (Street and Öpik, 1984). The elements measured in the current work are all essential ones and are all macronutrients.

A nutrient deficiency can be defined as the level below which a given nutrient becomes limiting to the growth or development of a plant. In this experiment

values were initially compared to those given by Binns *et al.* (1980) for optimal, marginal and deficient percentage contents of N, P, K and Mg. However, no direct comparison was valid as the determination of deficiencies should be carried out between the months of November and February when effects created by the accumulation and translocation of nutrients during the growing season are absent. The only values obtained in the present study which may be directly comparable, therefore, are those made on February 9th and in late November.

Studies on the nutrient concentrations of the foliage of *Pinus* spp. have shown varying results. Values obtained by several authors for the concentrations of the nutrients measured in the current work cover the ranges shown below;

N	7.7 to 22.5
P	0.8 to 2.3
K	2.3 to 7.8
Ca	0.3 to 4.8
Mg	0.2 to 2.3

All values are in g kg<sup>-1</sup> dry material and have been taken from the data set for the European Pine Model compiled by Schäfer and Krieger (1991). A full table of the values can be found in Appendix IV.

The relationship between the concentrations of the different nutrients with time in all trees measured is closely linked to growth and translocation. Generally, calcium would be expected to increase in concentration as the season progressed and the production and growth of new plant tissue took place since it is a major constituent of cell walls in the form of calcium pectate. The other nutrients measured in this study, however, would be expected to decline with time as after their initial uptake the amount per weight of tissue would decrease as the plants continued to grow. A further distinction between the nutrients is that calcium is poorly mobile and therefore remains close to its site of deposition whereas the others may be translocated to other regions of the <sup>plant</sup> thus lowering needle concentrations.

The results of the first set of measurements made prior to, and during, the early part of the growth season showed variation in needle nutrient concentrations with

time and between native and potted trees. For P, K and Mg the potted trees had larger amounts ( $\text{mg g}^{-1}$ ) than the native trees, but for N and Ca amounts were greater in the native trees. N deficiency may be due to a poorly established root system as suggested for *P. sylvestris* seedlings grown in Sweden (Ericsson *et al.*, 1984). If this is the case in the present work it would explain the difference between the values for the native and potted trees where the potted trees, with a restricted area for root extension, are clearly low in N but the comparatively unrestricted native trees only have low concentrations in a few cases. This reasoning may also explain why only the potted trees had small values of Ca and why all Ca concentrations in the needles of these trees were so much lower than those of the native trees. The compost in the pots originally contained ground limestone ( $\text{CaCO}_3$ ) which may have been leached by rainwater and surface run-off prior to this experiment. After this, restricted access to the surrounding soil may have prevented the trees from accumulating sufficient Ca in their needles.

For the two native populations measured in this part of the study the variation with time and between needle ages was found to be highly significant for each nutrient measured. The general trend with time was a decrease in nutrient concentration as expected which can be related to the increase in needle weight and size taking place simultaneously. Helmisaari (1990) found current needle dry weight for *P. sylvestris* growing in eastern Finland to be negatively correlated with concentrations of N, P, and K, but not related to concentrations of Ca and Mg. Decreases in the concentrations of mobile macronutrients (N, P, K and Mg) in mature needles with time was attributed to the transport of these nutrients to the growing shoots and needles, whereas more poorly mobile nutrients, (Ca, and to some extent Mg) which could not be retranslocated were found to accumulate gradually in the needles each growing season depending on their availability. Similar results have been found for *P. radiata* and cyclic patterns of nutrient accumulation, retranslocation and replenishment were observed in needles up to the age of two years (Fife and Nambiar, 1984).

The results of the second part of this study also indicated a decrease in nutrient concentrations of mature needles linked to the simultaneous increase in dry weight as a result of photosynthate production and size increase, as mentioned earlier. Decreases in P and K between July and August reported for *P. sylvestris* year n needles in Finland have been thought due to dry weight increases being faster than

nutrient transport (Helmisaari, 1990). If growth is small, such as that above the tree-line, there may be a greater tendency for high nutrient concentrations to develop and this could be a cause of some of the differences observed along the transect.

Needle nutrient concentration was found to vary significantly with altitude although at a lower level than either time or needle age in each case. For P, K Ca and Mg values were higher in the valley trees than in those above the tree-line which suggests that there is greater availability of nutrients in the valley, possibly because percolation and throughflow of water, and therefore run-off and leaching of nutrients, are all relatively less important in this area. This result opposes the theory of greater atmospheric pollutant inputs at high elevation (Fowler *et al.*, 1989). However, values for N were higher above the tree-line than in the valley for n-1 needles in September and in every month for the n needles.

Leaching of nutrients may have been of particular significance for the potted trees. Although the base of the pots had been removed when the trees were first placed at the site, on completion of the field part of the study it was noted that the roots had not grown outside the region of the pots. The roots would therefore have had very little access to nutrients other than those remaining in the original potting compost and it is likely that much of these would have been washed out over the previous year. A study on nutrient loss from fertilised peat in a closed system carried out in Dumfriesshire in Scotland indicated that during moderate to heavy rainfall leachate volumes corresponded closely to precipitation and therefore in a cool, moist climate heavy initial applications of fertilisers may be retained in peat (compost in pots) for only short periods (Malcolm *et al.*, 1977). Possibly a further extension of the present work would be to run a similar experiment with frequent, light applications of nutrients to eliminate altitudinal variation in growth resulting chiefly from a poor nutrient balance. This was not implemented in the current study because it was required that conditions were kept natural as far as possible to observe growth and development as it might take place in seedlings from the native trees.

An alternative view is that equal amounts of nutrients may be present in both areas but the uptake ability of the plants may be lower above the tree-line. In the cases of Ca and Mg values were higher above the tree-line in the year n needles in June.

This could be explained in terms of the comparatively slower development of the needles at this altitude related to the timing of onset of growth (refer to chapters 2 and 5). As these needles showed a developmental lag behind those in the valley at this time it is likely that they were of a smaller size and therefore the amounts of Ca and Mg acquired via the transpiration stream in early growth was still high relative to the leaf weight. It is unlikely that nutrients are present in equal amounts along the transect not only because of climatic and topographic effects on leaching but also because soils tend to be deeper in valleys and at the base of hills and therefore have a greater storage capacity. Circulation is also likely to be greater as larger trees have a greater turnover ability and other species (plant and animal) which contribute may benefit from comparatively longer seasons of activity as a result of warmer temperatures as lower altitudes.

### *General discussion*

When considering the water potential and nutritional concentrations of a plant it should be remembered that the two are closely linked. Water movement and hence nutrient uptake and transport is dependent on a difference in water potential between two regions, and without such a gradient, will not take place. Limitations within this process include availability of the nutrients to the plant, the uptake capacity of the plant and the mobility of the nutrients within the plants.

The most negative water potentials measured occurred in early May and late August and coincided with low values of N (potted) and P (native). In periods of high water potential (eg. June to late July for the native trees) no notably low concentrations were observed. It is thought that this pattern may be a direct reflection of the water balance of the trees in that nutrients are supplied to the needles in part by means of water uptake. The peak observed in needle water potential occurred throughout the main elongation period when both water and nutrients were required for growth.

The optimal quantity of an essential nutrient varies with the age of the plant and with the altitude at which it is grown. In Britain the optimum N level for *P. nigra* var. *maritima* varies with age and is thought to be associated with changes in the relative proportions of sources and sinks within the trees (Miller *et al.*, 1981).

Some of the variation between the native and potted trees in the current work may be attributed to similar differences in the optimum levels of nutrients as the native trees were thought to be up to 10 - 15 years older than the potted ones. The low N values observed in the potted trees at all stations in the early part of the season may just reflect the higher requirement necessary for the rapid growth of these young plants. The corresponding values for native trees were higher and may be related to the accumulation of nutrients with age.

Variation in nutrient requirements with altitude at this site is more complex. Shallow, peaty soils have low available nutrient contents and probabilities for recycling largely as a result of slow breakdown of organic matter under acid conditions. This effect may be particularly important for trees growing at higher elevations where low temperatures reduce the activity of soil organisms and contribute to the slow turnover rate of nutrients in the soil. A study of *P. sylvestris* growing at 625 m in the Pennines showed growth to be limited, particularly by K, even though soil nutrient levels were equal to those normally considered to be adequate at lower elevations (Brown *et al.*, 1964 (unseen) cited by van den Driessche, 1974). The authors concluded that a climatic effect, possibly one of temperature, was influencing nutrient uptake. It is possible that a similar conclusion can be reached for some results of the present work since having calculated the ratio of N:P:K it was found that all native trees had low values of K from February up until the end of May. Although little variation with altitude was apparent values were lowest at the highest station (675 m). Furthermore, a pattern observed between the N:P:K ratios of the young (n) and older (n-1) needles from the two native populations measured, suggests that a lag occurred in K accumulation in the trees above the tree-line behind those of the valley.

In addition to its effect on microbial activity, temperature also affects the rates of chemical reactions in plant processes and the permeability of membranes. It may also restrict nutrient and water availability through increased viscosity and freezing of soil water as mentioned earlier. As seen in chapter 2, growth is affected by temperature and both decrease with altitude at this site, therefore effects such as these may be of significance to the water and nutrient status of the plants especially at the higher stations and particularly in winter and early in the growth season.

A further factor of particular importance to the trees growing at the higher stations was that of needle damage, as described in chapter 3. Any damage to the needle surfaces is likely to increase water loss from the plant and result in lower water potentials of the needles. Water and nutrient uptake may initially be increased as a consequence of this change in the water potential gradient and could contribute to the slightly higher nutrient concentrations observed in some cases in the trees above the tree-line above those at lower elevations.

Another possible cause of the higher N values above the tree-line is that atmospheric deposition, particularly from cloud water, is likely to be greater at this elevation and may be sufficient to result in the difference observed. In recent decades increases in nitrate concentrations in air and rain have been observed and an increase in nitrate deposition in both rural sites and those close to major industrial regions (Brimblecombe and Stedman, 1982). Whilst some increase, particularly to nutrient-poor environments, may be regarded as beneficial in that some stimulation of growth may result, this source of input may be sufficient to disrupt the nutrient balance of current ecosystems and initiate changes in species' dominance hierarchy. High concentrations can be detrimental to growth especially within sensitive plant groups such as bryophytes which obtain essential nutrients almost exclusively from the atmosphere.

Studies on the chemical composition of acid fog in the Los Angeles basin have implied that the dominant processes involved are the condensation and evaporation of water vapour on pre-existing aerosol (Waldman *et al.*, 1982). This suggests that atmospheric concentrations of pollutants may promote fog/cloud formation by providing hygroscopic nuclei onto which water vapour droplets may condense, and once formed, the fog/cloud may incorporate further compounds which might increase deposition concentrations reaching vegetation. Although pollutants can be carried great distances in the atmosphere (eg. some pollutants measured in Scandinavia have been thought to originate from power station emissions in Britain) the prevailing winds in Britain are westerly and cloud formation and precipitation here is probably mainly orographic from the west coast. Input from marine sources are likely to include Ca, Mg, K and Na whereas nutrients originating from human impact will probably be N, P and S. Nitrogen deposition is likely to be the most important at Creag Fhiaclach, for example in the form of ammonia (NH<sub>3</sub>) from nearby agricultural practices. Input of nitrogen, particularly

on the upper slopes where low cloud is more frequent and where soils are likely to contain less nutrients, may enable certain plants to survive at altitudes which would otherwise be marginal to, or outside their range.

Some compensation for increases in needle nutrient concentrations takes place as a result of needle loss overwinter. Percentage values of needle survival are lowest at and above the tree-line and therefore plants in this region are more susceptible to desiccation and to reductions in storage capacities and hence nutrient deficiencies. It has been observed that *P. sylvestris* at altitudes of over 600 m are widely spaced at this site. Although many other factors influence the establishment and survival of the trees here it is possible that the distribution is determined edaphically in addition to climatic and biotic responses.

## **(v) Conclusions**

- 1.** The null hypothesis for needle water potential was rejected in the case of the potted trees but accepted for the native trees. Variation with altitude was thought to be related to the age and susceptibility of the potted trees to fluctuating conditions.
- 2.** The null hypothesis for needle nutrient concentrations was rejected. Significant differences in nutrient concentrations were found with time, needle age and altitude. A decrease in needle nutrient concentrations with time was attributed to a relatively faster increase in needle weight than in nutrient accumulation.
- 3.** N and P concentrations increased in year n needles early in the growth season but were low prior to its onset and after completion of needle elongation. The most negative water potentials were observed in all needles at these times.
- 4.** Values of nutrient concentrations were higher in the valley trees than in those above the tree-line. Low nutrient values were thought to be related to poor nutrient availability of the soil combined with restricted root growth and the effects of low temperatures.

## CHAPTER 5 : SEASONAL PHOTOSYNTHESIS OF CURRENT AND ONE YEAR-OLD SHOOTS OF NATIVE *P. sylvestris* TREES DURING 1990.

### (i) Introduction

The decline in growth as the tree-line is approached includes a reduction in both stature and the size of plant organs. In 1979 Tranquillini suggested that this could be a direct result of a shortage of organic materials due to deficient primary production. He showed that leaves at timberline have a lower temperature minimum for photosynthesis than those of a similar age and developmental stage in the valley.

Many environmental factors are likely to influence photosynthesis in relation to altitude, acting either singly or, more probably, simultaneously. Various suggestions have been made as to what the major ones are, temperature and water stress being two of the more common. The temperature range for net photosynthesis by most plants is approximately 5 °C more narrow than that either side of which leaves are killed or injured and the rates of photosynthesis and respiration can adapt to the prevailing temperature (Larcher 1980). Plants growing along an altitudinal gradient can therefore display evolutionary temperature adaptations to their own microclimate.

It was therefore considered important to include some measurements of the photosynthetic rates of the native pines at Creag Fhiaclach in an attempt to gain knowledge of the metabolic activities of the plants at this site and to detect any change with altitude. Much of the work carried out on Scots pine has been on detached shoots or needles and over short time intervals. An example of continuous measurements of net photosynthesis made *in situ* is that of Troeng and Linder (1981a,b) on a stand of twenty year-old trees in central Sweden. Field measurements on intact plants under natural conditions were chosen as the best method of experimentation in the present work since this would provide results directly comparable with those of the other experiments described earlier (chapters 2 and 3).

Aims and hypotheses were thus as follows;

To measure the photosynthetic rates of two populations of native Scots pine trees, one above the tree-line and one in the valley below and to determine any differences in those rates.

To investigate any differences between rates of current and one year-old needles, to establish an idea of the seasonal variation in such rates, and to detect the presence of any pattern through time.

The null hypothesis was;

$H_0$  : Current year and one year-old needles of *P. sylvestris* trees growing above the tree-line have equal rates of photosynthesis to the needles of corresponding age on trees growing in the valley below.

## **(ii) Materials and methods**

### ***Photosynthetic rates***

Measurements of the photosynthetic rates of *Pinus sylvestris* trees of approximately equal size and age were made on three separate occasions during 1990. The first group of measurements were carried out in late June, the second in early September and the third in late November. The dates on which the measurements were made are as follows;

June	26 to 28
September	4 to 6
November	27 to 29

All field work was carried out at Creag Fhiaclach (Grid ref: 855053) in the Cairngorm Mountains of Scotland, a full description of which can be found in section (vi) of Chapter 1.

Two sampling areas were chosen at the field site within each of which low-growing *P. sylvestris* trees occurred at approximately equal spacing. The areas were chosen with regard to similarity of tree height and morphology in order to reduce errors incurred by plant age and size differences. One area was chosen above the tree-line at an elevation of 600 m and the other at the edge of the valley below at 290 m. Above the tree-line the trees exist as small, isolated individuals and those measured were between 20 and 45 cm in height with an average spacing of 4 m. In the valley area the trees measured were between 60 and 80 cm tall and were spaced slightly closer at about 3 m. However, mature pines were also present in this area where the environment can be described as 'park-like' resulting from felling of taller trees in the past. The locations of both sampling areas are shown on a map (figure 1.4) in chapter 1.

Photosynthetic rates were measured on twelve trees at each altitude. On each tree both a current (year  $n$ ) shoot and a one year-old ( $n-1$ ) shoot were measured at the three different photosynthetically active radiation (PAR) levels.

Photosynthetic rates were measured using a battery-operated portable infrared carbon dioxide analyser (Model LCA-2, Analytical Development Company Ltd., Hoddesdon, Hertfordshire, England), connected to a large, cylindrical leaf chamber with quantum, humidity and temperature sensors which was designed specifically for use on pine shoots.

The Model LCA-2 carbon dioxide analyser uses a single beam portable system with a low voltage sealed infrared source at one end of the sample cell. Energy from the source passes through sample gas in the cell, through a sealing window and a narrow band pass thin film filter onto a solid state detector. In the differential mode the difference between the reference and analytical concentrations are displayed. The gas from the reference supply is passed to the cell for two seconds directly and then for two seconds through soda lime followed by a sample from the leaf chamber passed in a similar manner. The outlet from the cell exhausts through a flow meter to waste.

The leaf chamber is shown in Figure 5.1. It was constructed, for use with pine shoots, in the workshop at the University several years prior to the observations described here. The walls were all made from clear, acrylic plastic (Thermo

Designs, Edinburgh, Scotland) and were of 5.5 mm in thickness. They were glued together with "Tensol" cement No.70, a methyl methacrylate mixture (20:1, A:B). The upper panel was constructed of ICI Propafilm (ICI Films, Welwyn Garden City, Hertfordshire, England). This is a polypropylene film which transmits long wave infrared radiation but not short wave and therefore prevents the chamber and the shoot enclosed within it from becoming heated too much above ambient. It was attached to the chamber using double-sided sticky tape (Scotch Brand Tape, Minneapolis-St.-Paul, Minnesota, U.S.A.). Foam gasket (LI-COR, Inc., Lincoln, Nebraska, U.S.A.) was placed along the connecting faces of the two halves of the chamber and a closed pore, crosslinked polyethylene foam (Volara Type A, Voltek, Sekisui America Corp., Lawrence, Massachusetts, U.S.A.) was attached at the centre of each side to form a seal around the sample shoot. The temperature sensor consisted of a thermistor bead within an open-ended metal cylinder, as was the humidity sensor (Vaisala (UK) Ltd., Cambridge, England). Both of these sensors were fitted into sockets in the plastic and a close fit was made to avoid any spaces through which air might leak by wrapping PTFE tape (polytetrafluoroethylene, RS Components, Corby, Northamptonshire, England) around the base of each. Air was continuously mixed by a Micronel fan (Micronel V369L Radiatron, Twickenham, England) which was mounted in the base of the chamber.

The equipment was calibrated in the laboratory by disconnecting the flow meter and attaching the analyser to a set of Wösthoff mixing pumps (1 G27/3F, 1 SA 18/3F and 1SA 27/3F, H.Wösthoff oHG, Bochum, Germany). Air of a known concentration of carbon dioxide was pumped into the analyser which was then adjusted as necessary until the reading stabilised. Reference, analysis, differential and zero were all correctly set in this way.

For each tree, measurements were made firstly on current year shoots by enclosing the entire present year growth of any single shoot within the chamber. In some cases the current growth consisted of a single stem whilst others were multistemmed and it was sometimes necessary to remove a few of the one year-old

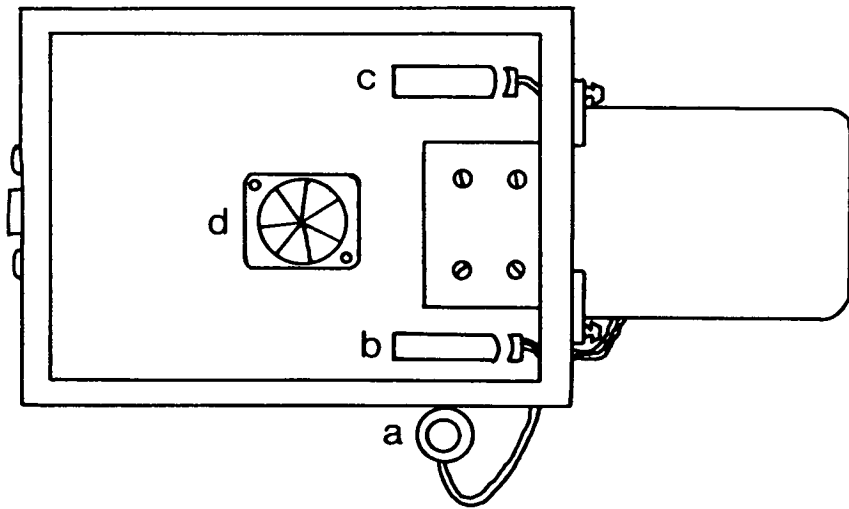
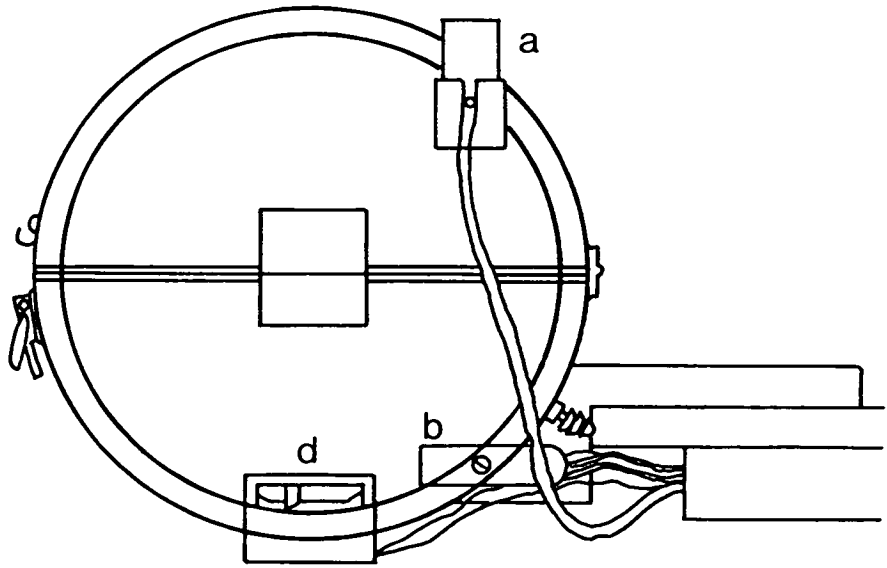

**Figure 5.1 :** Conifer leaf chamber with quantum sensor (a), temperature sensor (b), humidity sensor (c) and fan (d). Viewed from side (upper) and above (lower). Approx. 1/2 size.

needles growing adjacent to the current year needles in order to ensure a close seal around the stem at the point where it entered the chamber.

A minimum of five minutes was allowed for the air to equilibrate within the chamber before each reading was made. This was the length of time taken for a reading of zero to be obtained when the chamber was closed, empty and the analyser was in differential mode. Table 5.1 shows a series of readings taken in this way together with those of a separate test for relative humidity. This relatively long time interval was due to the large volume of the chamber which was such that true flushing of the system did not take place over a shorter period.

Readings were taken for each shoot at three different PAR levels, two of which were created artificially. The first reading was obtained using natural light. The chamber was hand-held and was orientated so that the quantum sensor faced the direction of maximum light as judged by eye. To avoid any breaking or undue bending of the shoot being measured, shoots were carefully chosen with this orientation in mind and this resulted in measurements being made on similarly-positioned shoots within any one sampling area.

Whilst maintaining this orientation a second light level was created by placing a sheet of white muslin, folded double, over the chamber. Again an equilibration period of five minutes was allowed before any readings were made. A third light level was created using a dark blue-coloured nylon material as a covering for the chamber, having first removed the muslin. The changeover between these two coverings was made as quickly as possible to minimise the effect of natural light entering the chamber on the photosynthetic rate of the shoot enclosed at that time.

The purpose of creating two further PAR levels in addition to that of natural light was twofold. Firstly, photosynthetic rates under a wide range of photon flux densities could be recorded and later observed in this way, giving a more complete idea of the response of the plants under varying light conditions. Secondly, this method allowed the possibility of more than one type of analysis to be carried out on the resulting data. Light response curves could have been constructed on either a population basis or for individual plants. As time was limited in the field, and daylength restricted the number of measurements which could be made, this method also minimised movement of the equipment between plants by reducing the

**Table 5.1 :** Results of equilibration tests of the conifer chamber ( $\mu\text{mol CO}_2 \text{ m}^{-2} \text{ s}^{-1}$ ).

---

<b>Differential test runs</b>						
<b>Time (mins)</b>	<b>1</b>	<b>2</b>	<b>3</b>	<b>4</b>	<b>5</b>	<b>6</b>
<b>1</b>	10	48	71	133	139	124
<b>2</b>	5	26	41	73	71	74
<b>3</b>	2	14	21	43	37	36
<b>4</b>	0	5	9	15	11	16
<b>5</b>	0	1	4	6	2	4
<b>6</b>	0	0	0	0	0	0

<b>Relative humidity test runs</b>						
<b>Time (mins)</b>	<b>1</b>	<b>2</b>	<b>3</b>	<b>4</b>	<b>5</b>	<b>6</b>
<b>1</b>	18	21	26	20	20	20
<b>2</b>	13	14	17	14	13	15
<b>3</b>	10	10	12	10	10	11
<b>4</b>	7	8	9	7	7	7
<b>5</b>	6	6	7	6	5	6
<b>6</b>	5	5	5	5	4	4

actual sample size of plants. Twelve was chosen as the largest sample size which could be measured during a single day after taking into account travel to the site and the setting up of the equipment. This was considered large enough to be representative of each sample area since variation between individual Scots pine trees tends to be small (Parker 1961; Troeng and Linder 1981b). Conductance was not measured since the plants were quite often wet and therefore stomatal resistances to water vapour were considered<sup>to</sup> have been removed.

After current year shoots had been measured the shoot was removed and placed in a clear, polythene bag. The one-year-old needles of the same shoot were then measured using exactly the same procedure and sampled as before. The shoots were returned to the laboratory for determination of shoot length and projected needle area.

Measurements were made throughout the day with short breaks to check the stability of the gas analyser when the chamber was closed without a shoot in it, ie. that the differential read zero. For all measurements the flow meter was placed as far from the analyser as the connecting tubing length would allow (approximately 2 m). The air intake tube was taped to a 2.7 m bamboo cane which was fixed into the ground in an upright position approximately 8 m upwind of the analyser and chamber. In this way any difference in the ambient carbon dioxide created by the presence of people making measurements was avoided. At the highest end of the cane the air intake tube was curved over so that the opening faced towards the ground to prevent anything from falling directly down into the tube and disrupting either the rate of flow or the composition of the air.

In all cases readings from the analyser were taken by hand in addition to those using the LCA-2 datalogger on the analyser as a precaution against battery failure and also as a check against later calculations and against equipment malfunction.

The data collected were downloaded at the end of each day onto a lap-top personal computer (Compaq SLT/286, Compaq Computer Corporation, Houston, Texas, U.S.A.) and saved on a 3½" diskette.

In the laboratory the length of all shoot samples were measured to the nearest millimetre using a transparent ruler. Projected needle areas were measured using a

LI-COR Model 3100 Area Meter (LI-COR Inc., Lincoln, Nebraska, U.S.A.) for both intact shoots and then for the needles after they had been removed from the stem. The values obtained were used together with the output from the gas analyser to calculate the actual photosynthetic rate for each shoot. This was carried out on a personal computer by means of a spreadsheet package (Lotus 1-2-3, Lotus Development Corporation, Cambridge, Massachusetts, U.S.A.), where the actual needle area was entered to replace the estimated area which had been pre-set into the memory of the data-logger analyser to enable calculations to be made during readings.

Using the same package a graph was plotted of photosynthetic rate in  $\mu\text{mol CO}_2 \text{ m}^{-2} \text{ s}^{-1}$  against PAR in  $\mu\text{mol photons m}^{-2} \text{ s}^{-1}$  for each needle age at each of the two sampling areas.

The values used to plot these graphs were transferred to a mainframe system where a statistical package (BMDP Statistical Software Inc., Los Angeles, California, U.S.A.) was used to fit a curve to each plot. The formula used to fit the curve was that for a rectangular hyperbola as described by Long and Hallgren (1985), with the addition of a further parameter to include respiration, or  $R$ . It should be noted that a typing error exists in equation 6.22 in Long and Hallgren's paper; the multiplication sign between  $k$  and  $Q$  should be an addition sign.

This equation was re-written as,

$$P_n = \frac{P_{g\max} Q}{k + Q} - R \quad [5.1]$$

where  $P_n$  is the observed rate of photosynthesis,  $Q$  is the photon flux density and the three unknown parameters  $P_{g\max}$ ,  $k$  and  $R$  represent light saturated assimilation rate of the whole curve (gross photosynthesis), the value of  $Q$  at half  $P_{g\max}$ , and respiration, respectively.

The numerical values of the parameters were estimated using the BMDP parameter optimisation program PAR, which iterates the parameters (starting with 'guessed' values supplied by the user) until the sum of squares of deviations between

calculated and observed values is minimised. The program worked well except for valley data of November when it was necessary to constrain  $R$  to 0.6 to obtain a good fit of the data. The predicted value of each observed reading was entered onto the corresponding file created previously on a spreadsheet and plotted as a single line of fit through the observed values. Curves were examined for goodness of fit; it was expected that residuals plotted against observed values would result in points close to zero with no distinct pattern or slope present. In each case the predicted curve was found to fit the data well, residuals were found to be randomly distributed.

The data sets of current year shoots for each site were then combined, as were those of one year-old shoots. Separately, within each site the data sets for both age classes of needles were combined. This resulted in four combined data sets for each sampling time for which curves were calculated using the same statistical package. Each time the package was run a print-out of the run was obtained on which estimated parameters and observed and predicted values were given. Having found the parameters, the calculated curves were superimposed on the data as before.

Values of the residual sum of squares for separate and combined curves given on this print-out were used to carry out a combined curve analysis of variance by putting them into the ANOVA scheme of Ross (1981) which tests the reduction in residual variance of the separate curves compared to the combined curve. A worked example can be found in Appendix V. Values used in the analysis and any significant differences obtained were tabulated.

The initial slope of each fitted curve (the apparent quantum efficiency) was calculated from the estimated parameters by taking the differential  $dP_n/dQ$  at  $Q = 0.0$  (Milthorpe and Moorby 1979),

$$\text{Initial slope} = \frac{P_{n\max} + R}{k} \quad [5.2]$$

All parameters ( $P_{n\max}^*$ ,  $k$  and  $R$ ) and the initial slopes were tabulated for the separate curves and for the combined curves.

$$* P_{n\max} = P_{g\max} - R$$

## Needle survival

In conjunction with the main experiment set up at the field site as described in chapter 2, needle survival of native trees was measured from one year to the next for two consecutive years. The number of new needles produced on one current year shoot was recorded early in the growth season of 1989 on the native plants at the five altitudes. These needles were re-counted in early spring of the following year to determine any losses over winter. The procedure was repeated for the new needles produced in the spring of 1990.

Percentage survival was calculated on a per site basis for the two years and results were plotted against altitude in the form of bar charts by means of the spreadsheet package Quattro Pro (Borland International Inc., California, U.S.A.). A two-way analysis of variance was carried out on the data using the package Statview 512+ (BrainPower Inc., Calabasas, California, U.S.A.).



### (iii) Results

#### *Photosynthetic rates*

Table 5.2 shows the mean needle areas of sampled shoots in the sampling area for the three measurement periods. The current year shoots had smaller areas than the one year-old shoots in June and to a lesser extent in September. This trend was due to the earlier developmental stage of the younger needles which had not reached their maximum size even by early September.

The mean needle areas were lower above the tree-line than their respective valley areas for each age group of needles and for all measurement periods. This suggests that conditions were less favourable for needle growth above the tree-line and therefore that the environmental conditions of the two areas are distinct from one another. Also, needles above the tree-line were visibly fewer in number per shoot compared to those of the valley and had a shorter but more flattened appearance in contrast to the longer, more slender needles of the valley trees. A similar observation was made by Haller in 1962 (unseen) cited by Tranquillini (1979).

The within-site variation was between  $\pm 0.6$  and  $\pm 2.2$  cm<sup>2</sup> for June and September but had increased by November to between  $\pm 3.6$  and  $\pm 5.4$  cm<sup>2</sup>. By November the mean needle areas had increased dramatically as the current year needles were now fully expanded.

The light response curves for the June measurements are shown in figure 5.2. The curves for the valley generally have a steeper initial slope and level off at a higher photosynthetic rate than those for above the tree-line. This suggests that the conditions existing within the valley are more favourable for photosynthesis than those above the tree-line at this time of the year.

If the results within either sampling area are considered, it can be seen that the year *n* shoots have much lower rates of photosynthesis than the corresponding year *n-1* shoots in each case. This provides a second example of the early developmental stage of the year *n* needles at this time in the growth season.

**Table 5.2 :** Mean leaf area of sampled shoots in the sampling areas (cm<sup>2</sup>), and standard errors for each measurement period.

---

	Shoot age	June	September	November
<b>Tree-line</b>	n	5.3 ± 0.6	8.0 ± 0.7	20.9 ± 3.6
	n-1	12.0 ± 1.4	9.8 ± 1.0	
<b>Valley</b>	n	9.2 ± 1.3	9.5 ± 0.9	23.9 ± 5.4
	n-1	12.1 ± 1.4	11.7 ± 2.2	

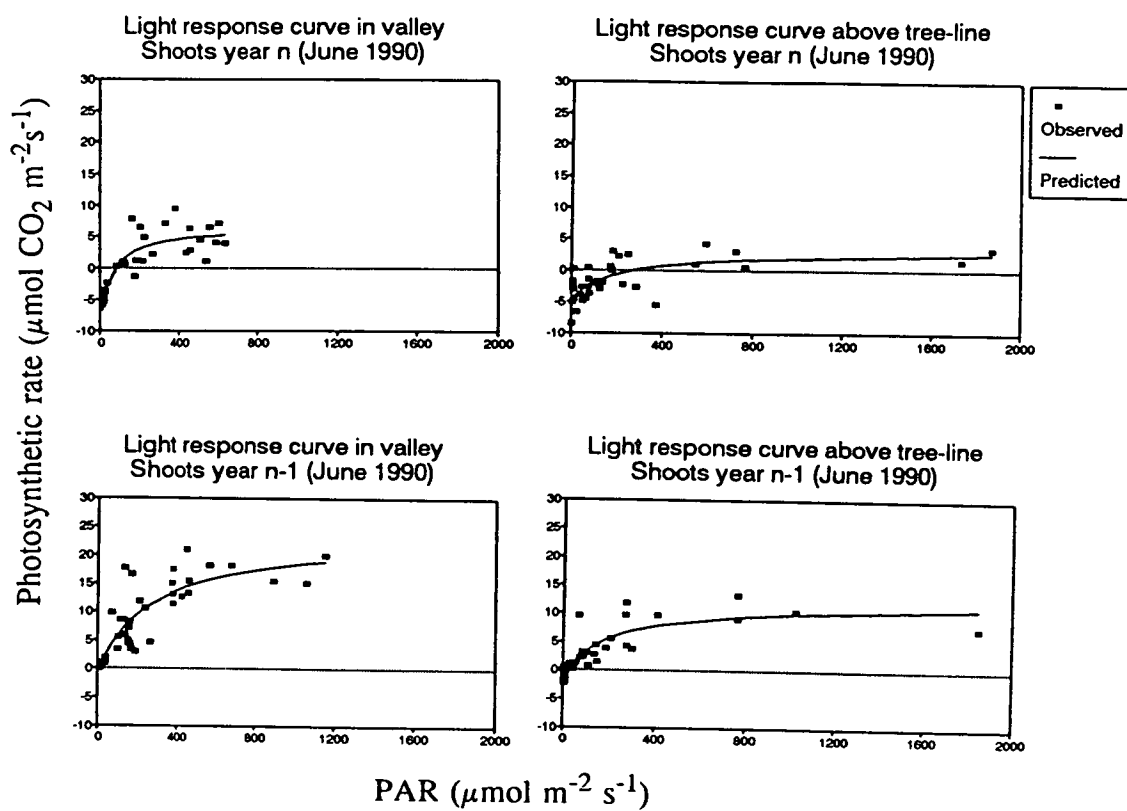

**Figure 5.2:** Light response curves for year n and year n-1 *P. sylvestris* shoots at both sampling areas in June 1990.

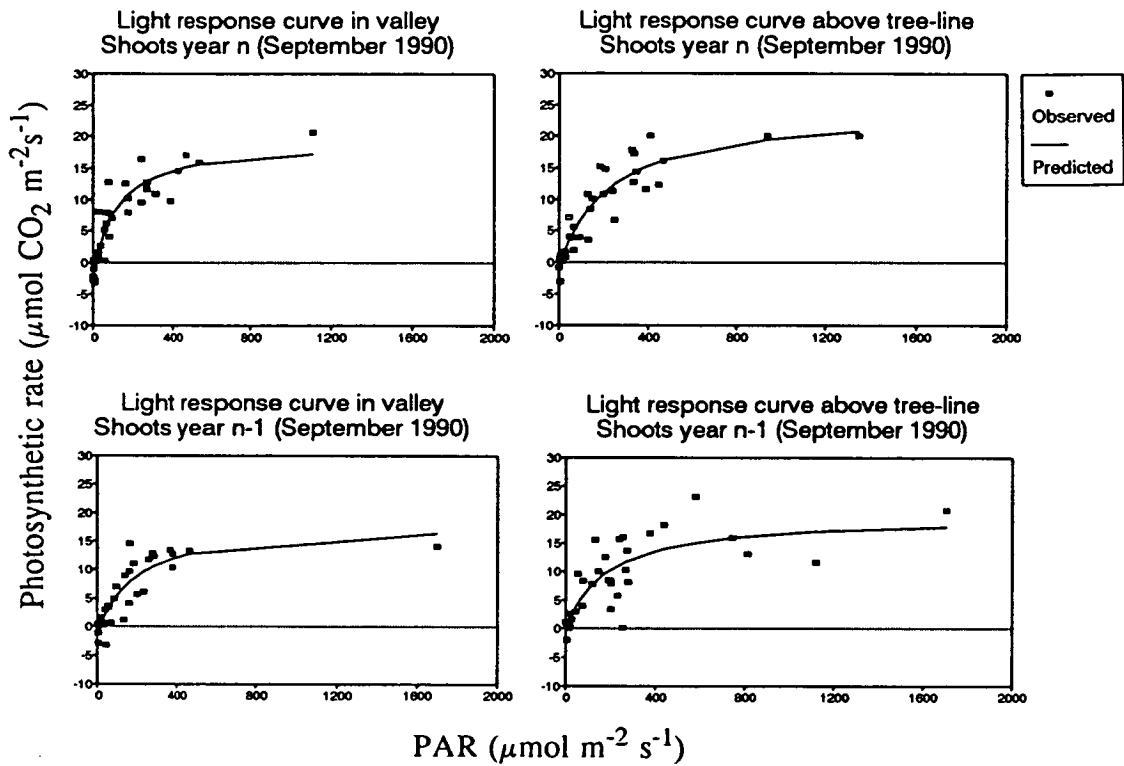

**Figure 5.3:** Light response curves for year n and year n-1 *P. sylvestris* shoots at both sampling areas in September 1990.

Figure 5.3 shows comparable graphs for the September data. In this case much less difference is apparent between the initial slopes and the maximum height of the curves of either sampling area or needle age class. At this point in the growth season there appears to be very little advantage photosynthetically at either sampling area. There is also much less difference between the rates of the year  $n$  shoots and those of the year  $n-1$  shoots indicating that the younger shoots had increased their photosynthetic potential by this time having advanced in development over the last two months.

Results of the November measurements are shown in figure 5.4 on two different scales. On the same scale as the earlier data (upper graphs) the dramatic reduction in the amount of photosynthesis within both sampling areas since the previous measurements can be noted. The lower graphs show the pattern of distribution of observed values which can be seen to resemble plots from earlier in the year. Although actual photosynthetic rates are now much lower, all below  $5 \mu\text{mol CO}_2 \text{ m}^{-2} \text{ s}^{-1}$ , the trees above the tree-line have both a steeper initial slope and a higher value of  $P_{n\text{max}}$  than those in the valley.

Table 5.3 shows the values of  $P_{n\text{max}}$ ,  $k$  and  $R$  and the gradients of the initial slopes for all curves described so far, (ie. figures 5.2 to 5.4). The mean  $P_{n\text{max}}$  value almost doubled in size from late June (11.3) to early September (20.4) and then fell to approximately one tenth of its former value by the end of November. The variation, as mentioned previously, was greater (s.d. 8.8), both between sampling areas and between shoot age groups, for the June data than for the September data when values were fairly similar throughout, (s.d. 2.8). For November the variation was less still but actual values were comparatively low.

Values of  $k$  followed a similar seasonal pattern of variation as would be expected due to the method by which  $k$  is derived. Respiration is greater where  $P_{n\text{max}}$  is lower and *vice versa* in June and to a lesser degree in September and November. Again this reflects the change in photosynthetic efficiency of the shoots as the season progresses where younger shoots are respiring more than older ones early in the season and their net carbon gain is lower. Although readings were positive for shoots measured above the tree-line in November the data are undoubtedly less dependable than those of June and September. The rates of photosynthesis were

\*  $P_{n\text{max}}$  —

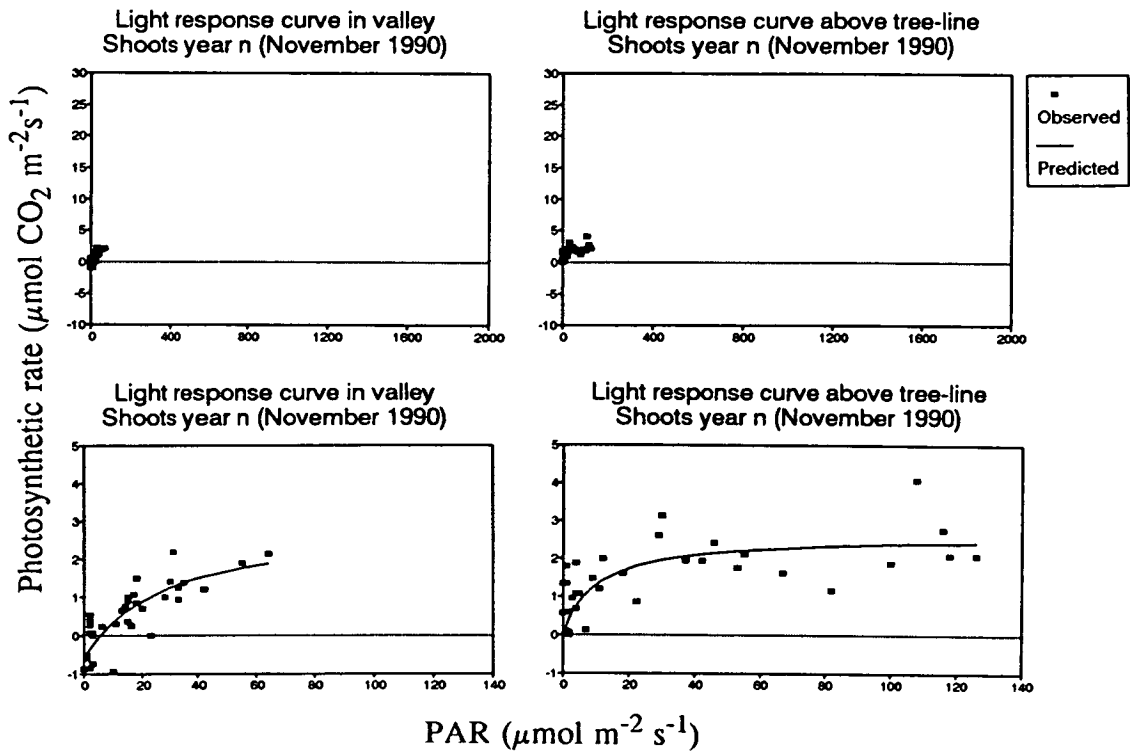

**Figure 5.4:** Light response curves for year *n* *P.sylvestris* shoots at both sampling areas in November 1990. The upper graphs are to the same scale as figures 5.2 and 5.3, the lower are the same data shown on a larger scale.

**Table 5.3 :** Values of  $P_{nmax}$ ,  $k$ ,  $R$  and the gradient of the initial slope for  $n$  and  $n-1$  shoots at both sampling areas for each measurement period.

		$P_{nmax}$	$k$	$R$	Initial slope
<b>June</b>	<b>Tn</b>	3.3	741.9	4.8	0.01
	<b>Tn-1</b>	12.1	227.6	1.5	0.06
	<b>Vn</b>	6.5	210.1	10.0	0.08
	<b>Vn-1</b>	23.2	277.4	0.8	0.09
	$\bar{x}$	11.3	364.2	4.3	0.06
	s.d.	8.8	253.4	4.2	0.03
<b>Sept.</b>	<b>Tn</b>	24.4	242.9	0.9	0.10
	<b>Tn-1</b>	19.8	186.1	0.3	0.11
	<b>Vn</b>	19.3	139.6	2.2	0.15
	<b>Vn-1</b>	18.1	203.8	1.5	0.10
	$\bar{x}$	20.4	193.1	1.2	0.12
	s.d.	2.8	42.8	0.8	0.03
<b>Nov.</b>	<b>Tn</b>	2.4	6.1	0.0	0.40
	<b>Vn</b>	2.0	67.4	1.5	0.05
	$\bar{x}$	2.2	36.7	0.8	0.22
	s.d.	0.3	43.3	1.1	0.24

low and consequently the  $\text{CO}_2$  differential was close to the limits of resolution of the analyser. Thus, respiration and initial slope cannot be accurately measured. However, it is clear that  $P_{n\max}$  is considerably lower in November than in June and September and the results from above the tree-line suggest there may be good adaptation to low light levels and poor conditions by the plants in this area.

The initial slopes of the fitted curves describe the apparent maximum quantum yield (Long and Hallgren, 1985) of the shoots concerned where a steeper slope indicates greater efficiency of light utilisation by photosynthesis than a more gently sloping one. From this it can be seen that year n-1 shoots are more efficient in June, especially above the tree-line, than the unexpanded current shoots and that a changeover in this efficiency takes place as the season progresses; firstly in the valley (September) and later above the tree-line (November).

Figures 5.5 to 5.9 show the observed values and fitted curves of the combined data sets for each measurement month. All current year data for June is combined in the upper graph of figure 5.5 whilst the lower graph shows the combined data of the year n-1 shoots. When compared with the plots for the respective individual data sets it can be seen that the effect of combining the data results in a predicted curve which lies roughly mid-way between the two original plots for the year n shoots but more closely resembles the valley plot for the n-1 shoots. In figure 5.6 the shoot age groups are combined within each sampling area and in each case the fitted curve appears more similar to the individual plots of the older shoots although the overall scatter is large.

Similar comparisons made for the September data reveal very little visual difference between the combined (figures 5.7 and 5.8) and the individual (figure 5.3) plots. This is not surprising since there was little variation between the original four sets of results for this month.

The combined data for November, shown in figure 5.9, has a pattern more similar to the tree-line than that of the valley data sets from which it is constructed. In this case the comparison differs from those made previously because the formula used to obtain the predicted curve was constrained to give  $R=0.6$  when applied to the valley data set in order to obtain a fit. Without such alteration the curve did not

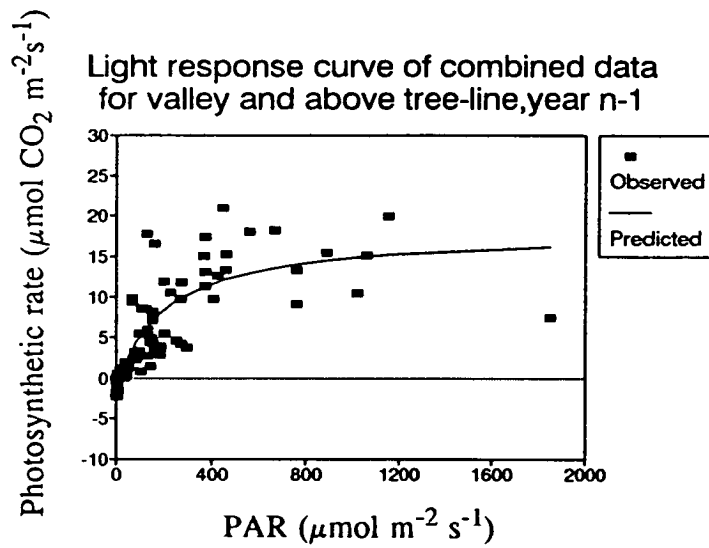
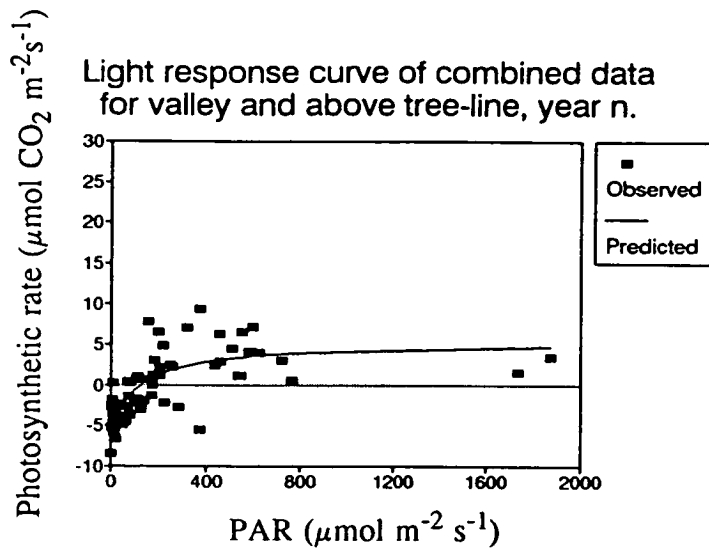

**Figure 5.5:** Light response curve for combined data of year n(upper) and year n-1(lower) shoots at both sampling areas in June 1990.

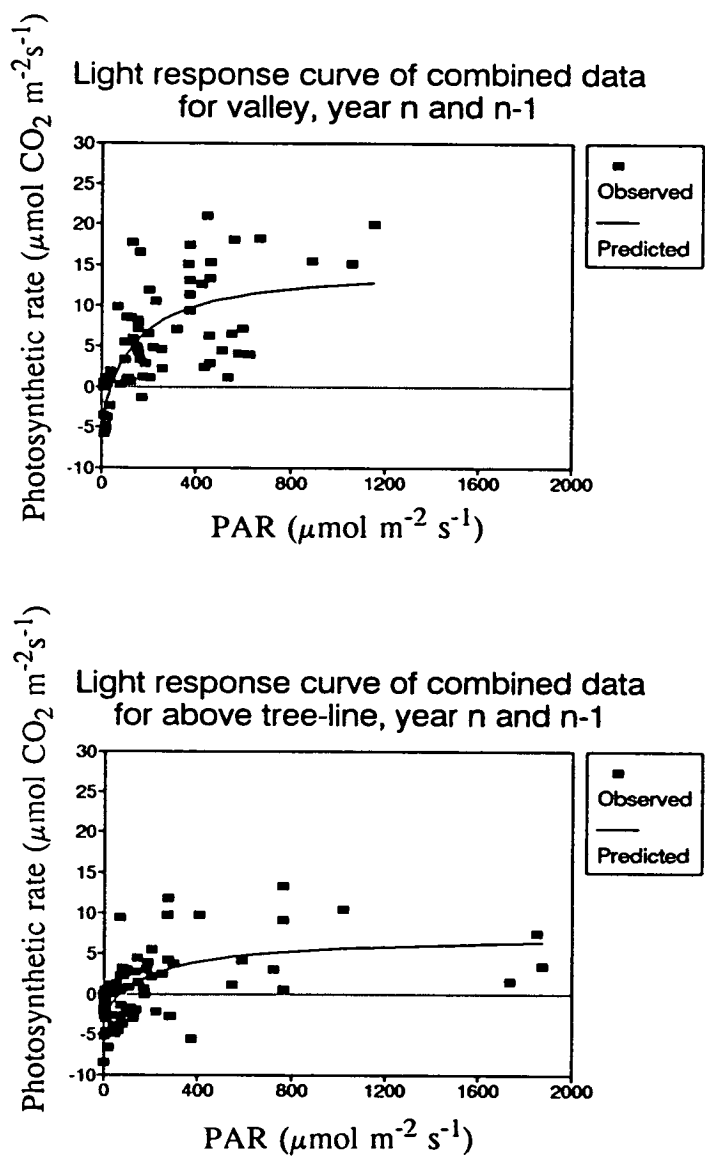

**Figure 5.6:** Light response curve for combined data of valley(upper) and above tree-line (lower) shoots for both shoot age groups in June 1990.

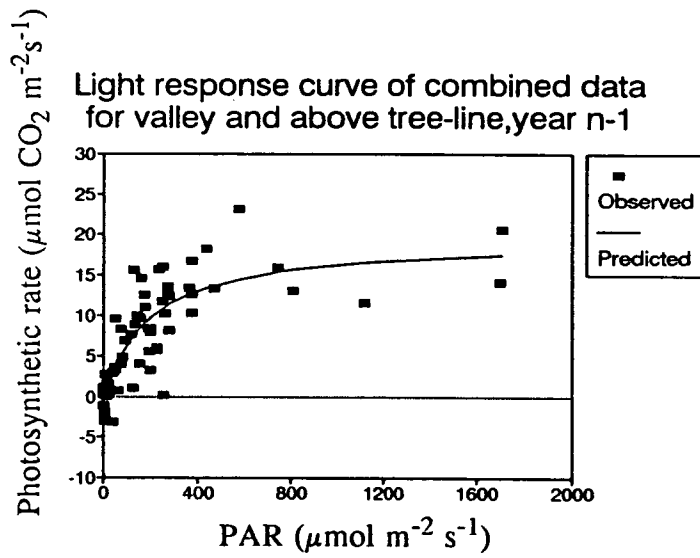
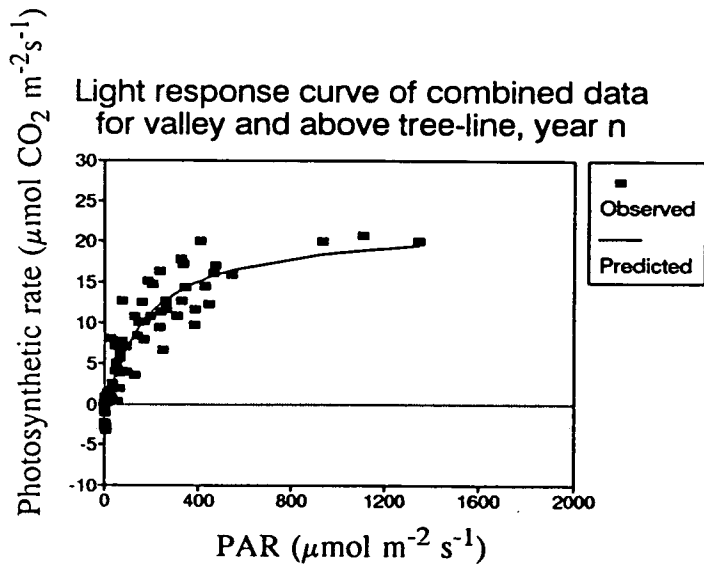

**Figure 5.7:** Light response curve for combined data of year n(upper) and year n-1 (lower) shoots at both sampling areas in September 1990.

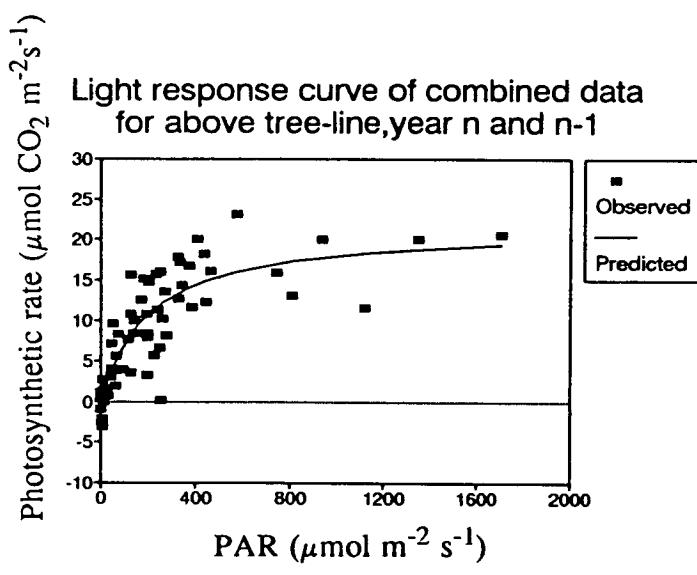
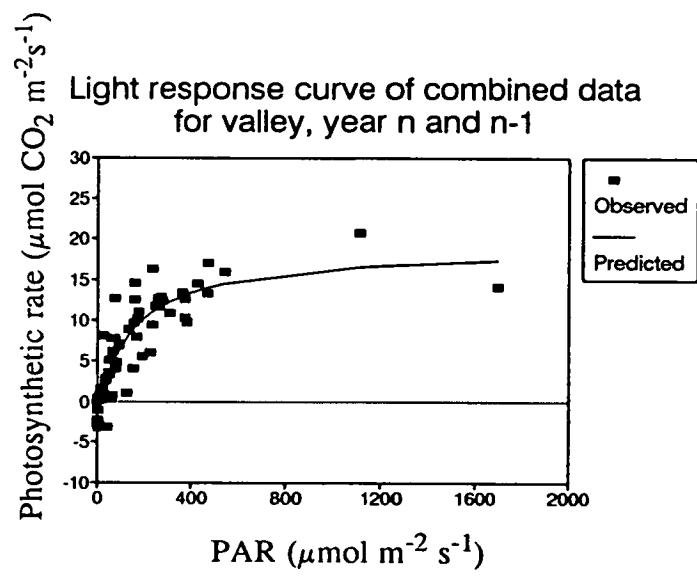

**Figure 5.8:** Light response curve for combined data of valley(upper) and above tree-line (lower) shoots for both shoot age groups in September 1990.

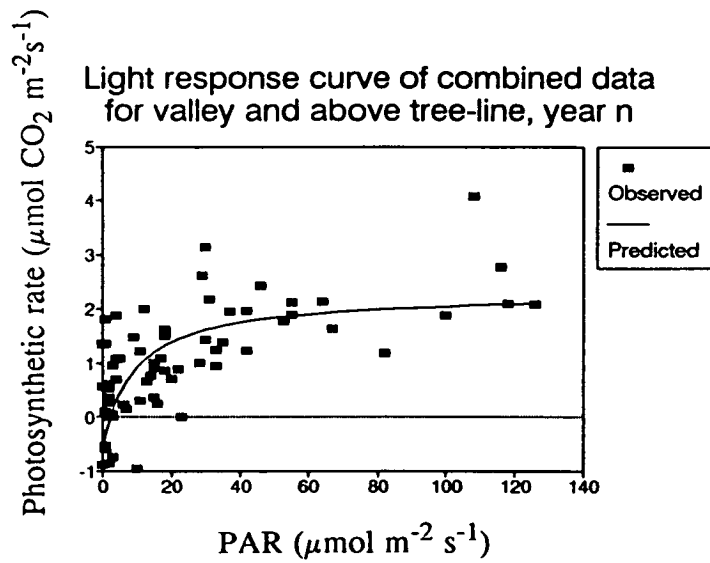
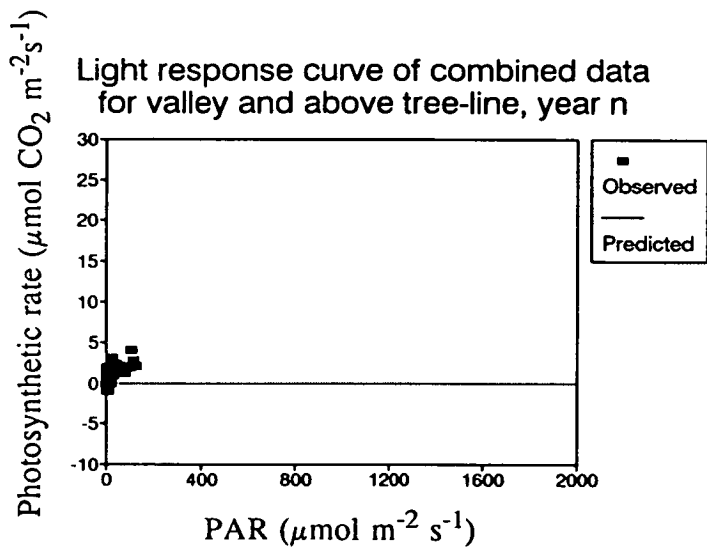

**Figure 5.9:** Light response curve for combined data of year n shoots at both sampling areas in November 1990. Scales as for figure 5.4.

pass through the negative values (ie. it did not include respiration) but went through the origin of the axes.

Values of  $P_{nmax}$ ,  $k$ ,  $R$  and the gradient of the initial slope for the curves of the combined data sets are shown in table 5.4. The means of these values are similar to those of the separate curves and the standard deviations are lower, as expected. The individual values in most cases lie between the two corresponding values of the separate curves. The exceptions occur in the June data for sets Tn-1 and Vn-1 where the value of  $R$  for the combined data exceeds both values for the separate data. Also in the November data the value of  $P_{nmax}$  for the combined data is greater than either value for the separate curves. This arises from the way in which the curve is fitted to the combined data. The fit created is the best possible using the method described previously but since the pattern of the data influences the fit, when the data is combined the curve produced is not likely to occur at an exact mid-way point between the two curves of the separate data sets. This variation therefore means that the values of  $P_{nmax}$ ,  $k$  and  $R$  will also vary accordingly.

In the same way the initial slope of the combined curves may be equal to half way between those of the separate curves or may be much closer to one, or be either side of both. For June the slope is steeper for all valley shoots when the data is combined but for all year n shoots the combined curve is less steep than either individual slope. The slope for all year n-1 shoots is much closer to that of the valley whilst that for the combined tree-line data produces a slope approximately mid-way between the two separate curves.

For September and November all combined slopes are between the two respective separate slopes.

Table 5.5 shows the results and significance levels from the combined curve analysis of variance together with some of the values used in the calculations. For the June data all tests were significant, three at the 0.1% level, indicating that the curves describing the individual data sets were significantly different from each other and therefore that the photosynthetic rates were significantly different between the sampling areas and the needle ages compared.

**Table 5.4 :** Values of  $P_{nmax}$ ,  $k$ ,  $R$  and the gradient of the initial slope for curves of combined data sets for each measurement period.

Combined data set	$P_{nmax}$	$k$	$R$	Initial slope
<b>June</b>				
Tn & Tn-1	7.4	362.3	2.8	0.03
Vn & Vn-1	14.8	221.8	4.8	0.09
Tn & Vn	5.3	370.3	6.2	0.03
Tn-1 & Vn-1	18.1	233.1	1.7	0.08
$\bar{x}$	11.4	296.9	3.9	0.06
s.d.	6.0	80.4	2.0	0.03
<b>Sept.</b>				
Tn & Tn-1	21.7	207.8	0.7	0.11
Vn & Vn-1	19.0	177.2	1.7	0.12
Tn & Vn	22.2	195.8	1.4	0.12
Tn-1 & Vn-1	19.4	202.0	1.0	0.10
$\bar{x}$	20.6	195.7	1.2	0.11
s.d.	1.6	13.2	0.5	0.01
<b>Nov.</b>				
Tn & Vn	2.8	9.7	0.1	0.30
$\bar{x}$	2.2	36.7	0.8	0.22
s.d.	0.3	43.3	1.1	0.24

**Table 5.5 :** Values used in combined curves analysis of variance with levels of significance using procedures recommended by Ross(1981).  
 (\*\*\*) P = 0.001; \*\* P = 0.01; \* P = 0.05)

June	Sums of squares	Degrees of freedom	Mean squares	Variance ratio	$F_{table}$
<b>Vn-1 &amp; Tn-1</b> Difference between curves	314.16	3	104.72	11.05	6.12 ***
Deviations from fitted curves (error)	644.43	68	9.48		
<b>Vn &amp; Tn</b> Difference between curves	162.08	3	54.03	8.77	6.17 ***
Deviations from fitted curves (error)	369.79	60	6.16		
<b>Vn &amp; Vn-1</b> Difference between curves	1287.92	3	429.31	66.37	6.16 ***
Deviations from fitted curves (error)	401.02	62	6.47		
<b>Tn &amp; Tn-1</b> Difference between curves	183.59	3	61.20	5.65	4.07 **
Deviations from fitted curves (error)	715.44	66	10.84		
<b>September</b>					
<b>Vn-1 &amp; Tn-1</b> Difference between curves	28.22	3	9.41	0.83	2.38
Deviations from fitted curves (error)	746.67	66	11.31		

**Table 5.5 (contd.)**

	<b>Sums of squares</b>	<b>Degrees of freedom</b>	<b>Mean squares</b>	<b>Variance ratio</b>	<b><math>F_{table}</math></b>
<b>September (contd.)</b>					
<b>V<sub>n</sub> &amp; T<sub>n</sub></b>					
Difference between curves	14.11	3	4.70	0.72	2.38
Deviations from fitted curves (error)	429.99	66	6.52		
<b>V<sub>n</sub> &amp; V<sub>n-1</sub></b>					
Difference between curves	56.39	3	18.80	2.92	2.92 *
Deviations from fitted curves (error)	425.44	66	6.45		
<b>T<sub>n</sub> &amp; T<sub>n-1</sub></b>					
Difference between curves	27.66	3	9.22	0.81	2.38
Deviations from fitted curves (error)	751.22	66	11.38		
<b>November</b>					
<b>V<sub>n</sub> &amp; T<sub>n</sub></b>					
Difference between curves	19.19	3	6.40	15.05	6.15 ***
Deviations from fitted curves (error)	26.77	63	0.43		

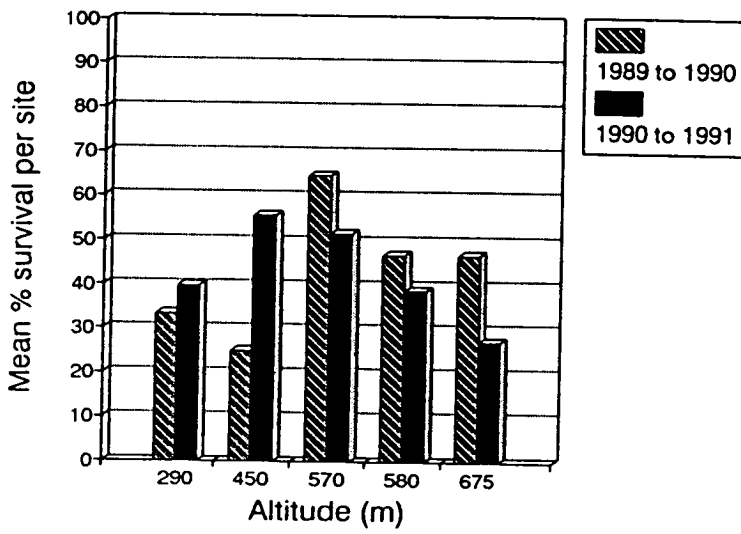

**Figure 5.10:** Mean percentage needle survival for two consecutive years at five altitudes for native trees.

Only one significant difference existed between the curves compared for the September data. That was for the valley shoots where the year n shoots had significantly higher rates of photosynthesis than those of year n-1 at the 5% level ( $P=0.05$ ).

For the November data the rates of the tree-line shoots were significantly greater than those of the valley, this was at the 0.1% level of significance.

### *Needle survival*

Figure 5.10 shows the mean percentage needle survival from 1989 to 1990 and from 1990 to 1991 for the native trees. Survival increased with increasing altitude to a peak at around 570 m after which it decreased. At three of the altitudes (290 m, 580 m and 675 m) less than 50% of the needles survived in either year.

Differences were found in the percentage needle survival between the two years measured. At the lower altitudes (290 m and 450 m) survival was greater over the second winter but at all other sites it was higher over the first. Overall the differences in survival between years were small being between approximately 5 and 10%. However, at 450 m survival from 1990 to 1991 was more than double that of the previous winter.

#### (iv) Discussion

##### *The seasonal pattern*

The photosynthetically active period can be defined as the months in which the net carbon balance is positive. Within this period photosynthetic rates are likely to first increase during the post-winter 'recovery' period. This is the time in spring when conifers undergo a dehardening process and reconstruction of partially-destroyed photosynthetic apparatus (notably chloroplast membranes, Öquist and Martin, 1980) takes place in the needles which survived the winter. Photosynthetic capacity gradually increases, as the season progresses, then stabilises at or near full potential as constrained by environmental conditions. Finally, rates decline as conditions become limiting with the onset of winter and falling temperatures induce frost hardiness (Street and Öpik, 1984).

Widely-spaced intervals of data collection provided a view of the seasonal pattern of photosynthetic rates in the year. Measurements were made early in the growing season (late June) and later in the main period of photosynthesis to give a comparison in the rates between different times of the same season. Further readings were made in late November to discover whether the trees were photosynthetically active at this time of year and, if so, the extent to which photosynthesis was taking place.

The seasonal pattern of the photosynthetic rates of the current year shoots is related to the developmental rates of the needles as well as the environmental conditions acting upon the trees concerned. At this site *P. sylvestris* has been observed to flush from late May onwards and in this experiment the year *n* needles were very small (5 to 10 mm in length) at the time of the first measurements. Mean projected needle areas for whole shoots were between 5.3 and 9.2 cm<sup>2</sup> and maximum rates of photosynthesis between 3.3 and 6.5  $\mu\text{mol CO}_2 \text{ m}^{-2} \text{ s}^{-1}$  at this time. High respiration rates of the rapidly expanding needles would have provided the main sink for carbon at this stage thereby reducing the net gain of these shoots. Relatively small surface areas would restrict the amount of photosynthesis occurring, unless compensated for by increased rates, and thereby also restrict the net gain in carbon achieved.

By September the current year needles were considerably larger being between 25 and 35 mm in length and with a mean projected needle area of between 8.0 and 9.5 cm<sup>2</sup>. Values of  $P_{nmax}$  had increased threefold to between 19.3 and 24.4  $\mu\text{mol CO}_2 \text{ m}^{-2} \text{ s}^{-1}$  largely as a result of the greater potential surface area available for photosynthesis by this time.

In late November current year shoots still had positive photosynthetic rates despite much shorter photoperiods and lower temperatures than those necessary for maximum photosynthesis to occur. However, rates did not exceed 4.08  $\mu\text{mol CO}_2 \text{ m}^{-2} \text{ s}^{-1}$  and were generally about one half of this value. The fact that any positive values were recorded at all supports the idea that under suitable conditions of light and temperature Scots pine are able to assimilate carbon dioxide throughout the year to some extent (Troeng and Linder, 1981a).

Temperatures close to zero, as occur with the onset of winter, exert a chilling effect on plants. Photosynthesis is one of the first processes affected and can be further suppressed under conditions of high irradiance when enzyme activity can become inhibited (Powles, 1984). In the past, winter decrease in photosynthetic efficiency has been related to a reduction in chlorophyll content (Bourdeau, 1959; Bamberg *et al.*, 1967). More recent studies have emphasised the importance of photoinhibition which is a time- and light-dependent decline of photosynthesis that may occur after long-term exposure of plants to strong light. If such conditions persist photo-oxidation may result in which photosynthetic pigments become bleached, (Powles, 1984).

Öquist *et al.* (1980) distinguish frost hardening from winter stress, the former being an adaptive physiological response, the latter a physically and chemically induced destruction of the photosynthetic apparatus. An increase in temperature for several days during the winter will increase the photosynthetic efficiency of *P. sylvestris* (Bourdeau, 1959). Frost hardening at above zero temperatures does not reduce the quantum yields of net photosynthesis or photosynthetic electron transport in *P. sylvestris* (Öquist *et al.*, 1980) and for *Picea sitchensis* hardened shoots have been found to continue to photosynthesise at an unreduced rate after exposure to sub-zero temperatures (Neilson *et al.*, 1972). Winter stress, however, inhibits the electron transport chain and causes a block between the two

photosystems when the secondary electron acceptor, plastoquinone, no longer functions efficiently (Öquist and Martin, 1980). In early spring the electron transport capacity increases once more as the formation of new thylakoid membranes begins (Martin and Öquist, 1979).

From only three measurement periods in a single growth season a pattern can be seen in the change in photosynthetic capacity of current year shoots related to their developmental stage. Within season variations may also occur as have been observed for other species. For common silver fir (*Abies alba*) the relationship between the rate of maturation and temperature varied throughout the spring period with the stage of development (Pisek and Kemnitzer, 1968 (unseen) cited by Pelkonen and Hari, 1980). Rates of photosynthesis and respiration can adapt to changes in temperature within a few days through shifts in substrate concentrations and replacement of enzymes with isoenzymes of similar function but different temperature optima (Larcher, 1980). This provides an extension of several degrees to the range in which photosynthesis is not limited by temperature.

One year-old shoots, in the present work, were found to be a very significant source of carbon assimilate. The one year-old shoots displayed very high rates of photosynthesis in June and also showed an increase in photosynthetic rate between June and September although to a lesser extent as they were fully developed at the start of the season and therefore reached their full capacity to photosynthesise earlier. Also respiration rates would have been more constant in the older needles and their effect as a carbon sink would have been comparatively less. Although no measurements of photosynthetic rates were made between early September and late November it is possible that they remained high before declining around October presumably as a result of low temperatures and the onset of photoinhibition.

### *Interrelationships of needle age classes*

A distinct pattern can also be seen between the two age groups of the needles measured. The year *n* shoots at first have lower photosynthetic rates and lower quantum efficiencies than the *n-1* shoots. This difference narrows as the season progresses until a reversal takes place and the current shoots become the more productive parts. This pattern was observed by Gordon and Larson (1968)

working on four year-old *Pinus resinosa* trees where the peak of photosynthetic efficiency of the new needles coincided with a large increase in the export of photosynthate from them to other parts of the plants. Primarily the differences in the actual rates recorded and in the calculated values between the two age groups (Tables 5.3 and 5.4) is due to the age difference and hence the developmental stage of the needles, as mentioned previously. However, the differing seasonal pattern is not simply a lag in development since the current year rates not only reach those of the older shoots but by September have exceeded them. A similar result was found for detached needles of *Pinus pumila* in Central Japan where  $P_{nmax}$  of current year needles was less than that of year n-1 until September when it became larger, (Kajimoto, 1990). The length of the maximum photosynthetic period is therefore shorter for the younger needles but also more productive. Similar results for *P.sylvestris* in Central Sweden have been found by Troeng and Linder (1981a), and results of growth analysis in southern England implied that the initial growth of *P.sylvestris* shoots was mainly at the expense of materials stored in the old needles during the winter (Rutter, 1957).

Further insight to the differing patterns of seasonal photosynthetic rates between the two age classes can be obtained by looking at internal exchange of translocates between the needles of the two groups. An example of such work is that carried out on *Pinus strobus* plants kept in a cold frame in Ontario, Canada (Ursino *et al.*, 1968). By exposing plants to labelled carbon dioxide ( $^{14}CO_2$ ) and monitoring the subsequent position and concentration of it within the plants, it was shown that in addition to respiration and photorespiration, loss of  $^{14}C$  from the older shoots was a result of transport to the new, developing shoots and roots. Early in the growth season significant amounts of photosynthate were exported to the new expanding needles to compensate for the negative carbon balance of the current shoots. This gain by the young needles would allow them to continue respiration and to prevent the inability to photosynthesise from being a factor limiting to their growth and development. Ursino *et al.* (1968) found that by mid-July the current year shoots had replaced the year n-1 shoots as the primary assimilation centres and as exporters of photosynthate to the roots.

Similar experiments by Ericsson in 1978 on twenty year-old *P.sylvestris* in Sweden showed translocation from one year-old shoots to current year shoots to occur in May, and especially in June but hardly at all later in the year. In general he found

a five-day lag existed between exposure of the plant to  $^{14}\text{CO}_2$  and translocation completion. No translocation from year n-2 needles to the current shoot occurred unless the n-1 needles had been removed in which case these older needles acted as a reserve source of photosynthates to the expanding needles.

These ideas can be used to interpret the present results in a similar way with the gradual increase in the photosynthetic capacity of the current year shoots occurring in relation to a corresponding decline in the importance of the year n-1 shoots as the primary sources of photosynthates.

The June results (Table 5.5) show that the year n shoots had significantly lower rates of photosynthesis than the year n-1 shoots at each sampling area. Measurements made in September show the approximate 'crossing over' point in this pattern where each age group is of fairly equal importance in carbon turnover. Only one significant difference exists between the age classes at this point and although at a lower level ( $P=0.05$ ) it is in the opposite direction to that of June showing the younger needles to now be the major sites. The timing of this transition is in agreement with that found for *Pinus resinosa* where an almost complete reversal of translocation in the year n-1 shoots, from being upward to the current shoot to being downward to the roots, occurred at an interval of nine weeks after flushing of the new needles, (Gordon and Larson, 1968). The extent to which the rates of the younger needles exceeded the older after this point is not known for the present data since limited time prevented measurements to be made of year n-1 needles at a later date in the season.

These seasonal changes in photosynthetic rates involving rapid development of new needles and translocation of photosynthates between the different aged parts of the trees can be seen as a very efficient system within the plants to achieve maximum fixation of carbon dioxide in a relatively short period when environmental conditions are not limiting, in a way that results in sufficient new growth to compensate for needle losses incurred elsewhere on the plant.

### *Needle survival*

An idea of the percentage needle survival at this field site can be obtained from figure 5.10. As values shown represent the mean percentage survival of current year needles after their first winter these results can also be viewed as the percentage of reserves lost and no longer available to the following year's new growth.

Survival ranged between 25% and 65% in the first year measured, with greater survival above 450 m. In the second year values showed a more gradual change between stations, decreasing from 450 m with increasing altitude. For both years measured more than 30% of the current year needles were lost over winter (and in many cases 40% or 50%) representing a significant proportion of the potential photosynthetic surface area and of the stored reserves that might otherwise have become available to the new growth in the spring. That survival appears highest around 570 m and is distinctly lower at 290 m suggests an additional factor is acting upon the valley trees.

The survival of year *n* needles in any two consecutive years is likely to affect the development of the next new needles. If the survival is very low it may be possible that the current needles would not fully expand or mature from which it can be seen that increased losses over successive winters could greatly restrict growth of the trees and may even result in their death.

Needle loss over winter can be related to climate and in particular to temperature and wind as seen in chapters 2 and 3. Although the climate of this Cairngorm site is less extreme than many tree-line sites studied and no data are currently available on winter soil-freezing patterns here, it is possible that the cumulative drying and cooling effects of strong winds together with restricted water uptake are the major cause of needle loss over winter. However, the valley sampling area is much more sheltered and the degree of exposure to strong winds much less significant, yet needle survival of the plants was no greater here than above the tree-line. Though this statement might suggest that the reasons for winter needle loss given so far are invalid, the valley region is thought likely to be a 'frost pocket'. Frost damage and frozen soil may be the chief causes of needle loss in this area where wind is of relatively less importance.

These effects are likely to influence the photosynthetic development and performance of the trees to different extents between the two sampling areas largely as a result of the difference in altitude. The area above the tree-line is around 600 m and is over 300 m higher than that of the valley below. Temperatures experienced by the higher altitude plants are likely to be approximately 2.7 °C lower than those affecting the valley plants (as based on a lapse rate of 9 °C km<sup>-1</sup>; refer to chapter 2, also Grace, 1987) and therefore the microclimates at each sampling area can be said to be distinct. However, on some occasions the effect of the valley area as a frost pocket could result in a far smaller temperature difference between these two altitudes. The general difference between the two regions is reflected in the results where the rates of photosynthesis and the values of  $P_{nmax}$ ,  $k$  and  $R$  are significantly greater in the valley when the two altitudes are compared.

### *Altitudinal effects*

The largest differences between the two altitudes were found in June at the start of the growth season. At this time the influence of temperature on the recovery of the year n-1 shoots after the winter is likely to be the strongest factor determining the rates of photosynthesis (Ludlow and Jarvis, 1971). That the rates of the valley trees were significantly greater ( $P=0.001$ ) than those above the tree-line, for both shoot age groups suggests that there is a climatic advantage for photosynthesis at the lower site. Since mean daily temperatures are known to be higher within the valley than above the tree-line at this site this difference in rates between the two areas can be interpreted as a lag in development and maturation of the year n needles, and of the recovery of the year n-1 needles, at the higher elevation behind those of the valley trees due to the limiting effect of low temperatures. As temperature increases throughout the season it no longer limits this maturation and recovery, and plants therefore reach their full capacity to photosynthesise. This capacity is likely to be achieved earlier in the valley as temperature ceases to be limiting here before it does so above the tree-line.

However, other factors must be included when explaining the differences in the actual rates of photosynthesis recorded at the two altitudes because by September

no significant differences existed even though the plants above the tree-line were still experiencing lower temperatures than those in the valley, and in November the higher altitude trees exceeded the rates of those in the valley. This reversal between the two sampling areas could be a time lag in obtaining maximum rates or a genuine adaptation by the higher altitude trees of increased efficiency to photosynthesis at low PAR levels. The apparent quantum efficiencies as obtained from the initial slopes (Table 5.3) suggest that the trees at the higher altitude utilise PAR more efficiently in photosynthesis as the season progresses and exceed those of the valley trees at or around early September in a pattern similar to that of the values of  $P_{nmax}$ .

Contrary to the maximum rates of net photosynthesis, the efficiency of the year  $n$  shoots above the tree-line exceeded those of the valley prior to the same pattern occurring for the respective year  $n-1$  shoots, ie. the current year needles of the higher altitude plants became more efficient than the lower ones earlier in the year than the previous year needles. This indicates a strong selection for plants above the tree-line to rapidly establish and maintain high levels of quantum efficiency to enable maximum use of PAR for photosynthesis in the comparatively short growth season.

The idea that diffuse rather than direct radiation is more favourable to increased efficiencies has been demonstrated mathematically and shows the photosynthetic rate of a shoot to be higher during overcast skies than clear skies (Oker-Blom, 1985). It should be noted that the true quantum efficiency may bear little relationship to the apparent quantum efficiency determined here. This is because the geometry of the quantum sensor is different from that of the shoot, and not all quanta that impinge on the shoot are absorbed. The apparent quantum efficiency in the present study was often high and even exceeded 0.1. Some of the variation may arise from differences in shoot structure between altitudes as mentioned earlier in the results.

Differences in the seasonal pattern of photosynthesis between two sites of different microclimates have been shown by Häsler (1982; 1985) and Turner *et al.* (1982) where an east-facing slope experienced soil temperatures 3 to 4 °C higher than those of a north-facing slope of the same inclination (40°) only 25 m away (horizontal distance) in the upper subalpine zone of the central Swiss alps. The

initiation of the growing period for conifers was 5-10 days earlier on the east slope and the pines growing there (*Pinus cembra* L. and *Pinus montana* ssp. *arborea* Tubeuf) were able to fix approximately five times more carbon than those on the north slope, (Turner *et al.*, 1982).

The general effect of temperature is on metabolism. Early in the season low values are limiting to the metabolic processes involved which rely on certain thresholds above which they can function. As temperatures tend to decrease with increasing altitude these thresholds are reached earlier in the year at lower altitudes and in this way a lag effect can often be found, as seen here at Creag Fhiaclach.

### ***Further work***

Further work to aid the interpretation of these results would primarily involve additional measurement periods during the months not previously measured, notably July, August and October, to establish a clearer idea of the seasonal pattern of photosynthesis between the two age classes of shoots and between the two altitudes. Second, the addition of further sampling areas between the two measured here to investigate the transition in such patterns with altitude.

A further, interesting extension of this work would be to analyse the causes of change in the photosynthetic capacity of the trees throughout the main period of net photosynthesis by means of chlorophyll fluorescence. Öquist and Huner (1991) suggested that photoinhibition of photosynthesis under limiting temperatures allows controlled dissipation of excess excitation as heat to occur and in this way is of significance for evergreen species in cold, temperate climates. Determination of the extent to which photoinhibition is limiting at this site could be included together with the aid of soil-freezing experiments.

## **(v) Conclusions**

- 1.** In June, current year needles in the valley were more fully expanded than those at the tree-line, with higher rates of net photosynthesis in sunlight and lower light compensation points, as well as a greater area. Needles that had overwintered were making a major contribution to the net carbon balance, and those in the valley displayed about twice the rate of those above the tree-line.
- 2.** By early September, there was very little difference in the photosynthetic rates of trees in the valley and above the tree-line. Current year needles were fully expanded and had comparable rates of photosynthesis to the one year-old needles.
- 3.** By late November photosynthetic rates were very low, and for current year needles were higher above the tree-line. The reversal in highest rates between the two altitudes was thought to be partly a temperature-induced time lag effect but also an adaptation of increased quantum efficiency by the plants above the tree-line.
- 4.** Trees at both altitudes lost needles over the winter. The percentage lost was similar in each case and thought due chiefly to low temperatures, an effect increased in the valley by frost.
- 5.** The null hypothesis was rejected. Trees in the valley have higher rates of photosynthesis in the early growing season and trees above the tree-line achieve higher rates approximately three months after flushing. The seasonal pattern of photosynthesis is linked to needle expansion and development which, in turn, is linked to temperature (chapter 2), and influenced by other environmental differences between the sites.
- 6.** Further work should include comparable measurements during the months omitted here, the extent of photoinhibition, and the use of chlorophyll fluorescence to analyse causes of change in photosynthetic capacity.

## CHAPTER 6 : GENERAL DISCUSSION

### (i) Altitude and climate

Upland Britain experiences an oceanic climate. For much of the year, cool moist air from the Atlantic sweeps across the landscape causing mild winters and cool, cloudy summers. As air masses are raised over high ground they cool and condensation occurs. As a result of this, characteristic climatic relationships with increasing altitude occur.

The British uplands are particularly cloudy and wet; up to altitudes of about 1,000 m solar radiation and hours of sunshine decline as the incidence of cloud increases (Grace and Unsworth, 1988). Under these conditions evaporation and transpiration may decline rapidly with elevation, despite increases in wind speed. The rate of change in transpiration with elevation may be illustrated by using the Penman-Monteith equation;

$$\lambda E = \frac{\Delta R + \rho c_p (e_s(T) - e) / r_a}{\Delta + \gamma (r_a + r_c) / r_a} \quad [6.1]$$

where;

$E$  is evaporation rate ( $\text{kg m}^{-2} \text{s}^{-1}$ )

$R$  is net radiation ( $\text{W m}^{-2}$ )

$\rho$  is air density ( $\text{kg m}^{-3}$ )

$c_p$  is specific heat of dry air ( $\text{J kg}^{-1} \text{ }^\circ\text{C}^{-1}$ )

$e_s(T)$  is saturated vapour pressure at temperature  $T$  (kPa)

$\Delta$  is slope relating  $e_s$  to temperature ( $\text{kPa } ^\circ\text{C}^{-1}$ )

$r_a$  is aerodynamic resistance ( $\text{s m}^{-1}$ )

$r_c$  is canopy resistance ( $\text{s m}^{-1}$ )

$\lambda$  is latent heat of vaporisation of water ( $\text{J kg}^{-1}$ )

$\gamma$  is the psychrometric constant ( $0.066 \text{ kPa } ^\circ\text{C}^{-1}$ )

The stomatal resistance of the whole canopy ( $r_c$ ) was taken to be  $200 \text{ s m}^{-1}$  as recommended by Shuttleworth (1989), rather than the day-time average value of  $100 \text{ s m}^{-1}$  obtained for forest surface conductance from a variety of sources, since all other variables used in the equation were 24 hour means. At Creag Fhiaclach suitable climatological data for the calculation of transpiration rates were collected by Wilson *et al.* (1987) for the month of June 1985. The data were put into equation 6.1 and the results are shown in table 6.1 together with some values obtained by Körner and Mayr (1981) for low vegetation growing in the Austrian Central Alps. The aerodynamic resistances for the Scottish data were obtained from the curves calculated by Wilson *et al.* (1987, Fig.5.) according to vegetational height.

Transpiration rates were found to decrease with altitude for both sets of data although the rate of decrease was much greater at Creag Fhiaclach. Values were much higher in the Alps, for example they were over four times as large at 600 m. These variations can be attributed to climatic differences between the two locations. In the Cairngorms the actual evapotranspiration is often the same as the potential (approximately  $400 \text{ mm year}^{-1}$ ) with high air humidities and frequent hill mist at high altitudes (Green, 1981). At 850 m (Creag Fhiaclach) the transpiration rate was negative. The most likely cause for this is that this altitude is above the main condensation level and that the majority of water exchange with the atmosphere at this elevation is an input (from the atmosphere to the vegetation) rather than a loss.

Excess transpiration from the vegetation may occur in both regions but is likely to be a more important determinant of plant survival in continental climates where rainfall and cloud cover are less frequent. For tree-lines the effect of decreasing atmospheric pressure with increasing altitude will be more pronounced in the Alps where the position of the tree-line can often be above 2,000 m.

The decline in temperature with altitude in the Cairngorms often departs from more usual environmental lapse rates, as Wilson *et al.* (1987) observed. Figure 6.1 shows some lapse rates recorded in hills and mountains in various parts of the world including the mean of those calculated in the present study ( $8.5 \text{ }^\circ\text{C km}^{-1}$ ). It can be seen that the plot for Creag Fhiaclach is the least steep shown and that it is considerably less than that for south Scotland (data of Freezillah). The

**Table 6.1 :** Calculated rates of transpiration ( $\text{mm day}^{-1}$ ) at several altitudes at Creag Fhiaclach (calculated from data by Wilson *et al.*, 1987) and in the Austrian Central Alps (Korner and Mayr, 1981).

---

	<b>Altitude (m)</b>			
<b>Creag Fhiaclach</b>				
	<b>450</b>	<b>600</b>	<b>650</b>	<b>850</b>
	2.41	1.00	0.60	-1.65
<b>Austrian Central Alps</b>				
	<b>600</b>	<b>1,000</b>	<b>1,600</b>	<b>2,600</b>
	4.5	4.6	4.5	3.8

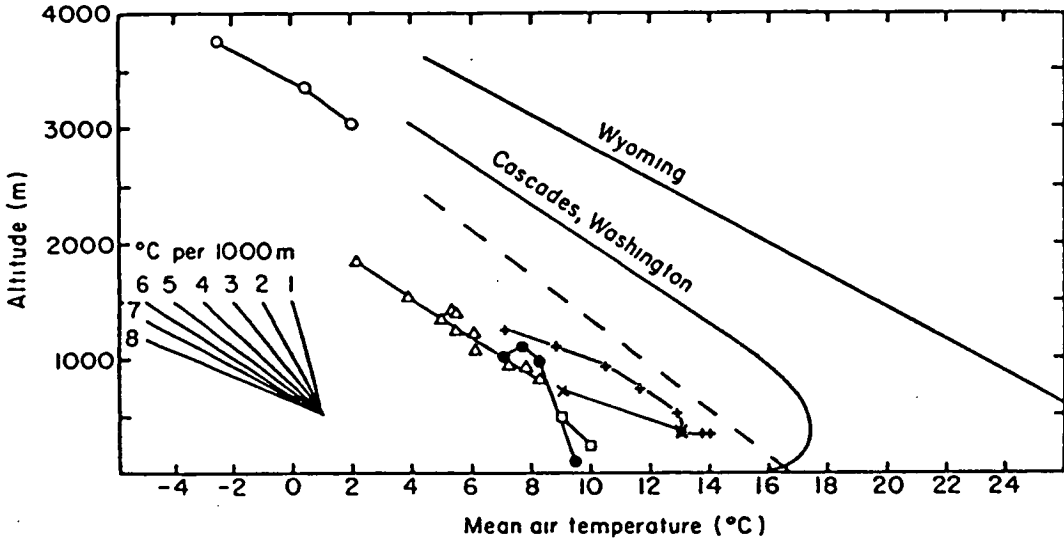

**Figure 6.1 :** Temperature lapse rates recorded in hills and mountains in various parts of the world. O, Wardle at Colorado; —, Baker at Wyoming and the west slopes of the Cascade mountains in July; Δ, Morris in New Zealand; --, Dickson in the south Appalachians; ●, Munro in Wales; +, Dybeck and Green in the Cairngorms (an incomplete year); □, Freezaillah in south Scotland; x, the present work at Creag Fhiaclach in the Cairngorms. (Reproduced with permission from Grace, 1977, where the original references may be found).

lapse rate is also greater than that given for the Cairngorms by Dybeck and Green which was constructed from an incomplete data set.

Climatic conditions at many tree-lines are more continental than in Scotland with more extreme seasonal temperature variations. Frequently the tree-line occurs well above 1,000 m and so the plants are growing above the main cloud level and are exposed to comparatively less precipitation but greater solar radiation.

Environmental lapse rates are also influenced by water and shade variations which are created to a large extent by the size and type of vegetation over which the air moves. Variation between areas along a single slope and between geographical regions can therefore be related to vegetational, as well as topographical and climatic differences.

The microclimate experienced by plants, and any gradient of this with altitude, may differ slightly from that even 1 m above the vegetation, as shown in the current study. Aerodynamic resistance to heat transfer ( $r_a$ ) has been shown to increase as the stature of the vegetation decreases (Wilson *et al.*, 1987; Grace, 1981; 1988) and therefore shorter or low-growing plants will tend to be less closely coupled to the atmosphere and may experience rather high temperatures in bright sunshine and lower temperatures at night when radiation is negative. In the current study there was evidence of a distinct change in the altitudinal gradient of mean monthly meristem temperatures at the tree-line (ie. between 570 m and 580 m). A comparable change did not occur in the mean monthly air temperatures measured 1 m above these plants, however. This may be attributed to the higher winds at the more open station above the tree-line (580 m). Such step-wise change may occur in other variables, for example the rates of mineralisation and the soil temperatures in winter. The microclimatic differences between sheltered and exposed sites may thus help to explain why the tree-line forms a relatively abrupt boundary.

The cooler meristems above the tree-line suggest that the young *P. sylvestris* seedlings in this area may be more often limited by temperature than those just below. In this way the effects of temperature on growth can be seen to be an important factor determining the position of the current tree-line at this site. Variation between the two lapse rates (air and meristem) along any section of the

transect is likely to have been influenced by wind effects as higher wind speeds, for example at the higher altitudes, would tend to lower the aerodynamic resistance of the plants and increase the degree of coupling with the atmosphere. Through this, differences in the relationship between air and meristem temperatures may be created between sections of the transect.

## **(ii) The altitudinal transect as an 'open-air laboratory'**

In chapter 1 (section vi) some aspects of the value of Creag Fhiaclach as a study site were highlighted, in particular, the lack of human disturbance at the tree-line. Whilst this site allows measurements of plant growth to be made under natural conditions, the nature of the experimental site does not provide scope for single factors varying independently as would be possible under growth room conditions. Since the variables influencing the plants in the field are often correlated the relative importance of single variables may be unclear. Results obtained in such a study must therefore be viewed with caution, particularly as correlations between variables may be different at other sites and may also be different in the future, given climatic change.

The alternatives to this type of field experiment include growth rooms and open top chambers. Although the former provide the opportunity to investigate the effects of a single variable under otherwise uniform conditions, the environment created is largely artificial and results may not represent the natural response of the plants. Most notably, perhaps, are the diminished diurnal and seasonal fluctuations in contrast to the dynamic nature of the natural environment. Whilst plant response to an individual variable may be recorded over a wide range the results may not be representative of the response under additional fluctuating variables. A further problem occurs in creating full summer sunlight and winter temperatures. It is for this reason that many researchers are not using growth rooms to study impacts of climate change on plants, but instead, open top chambers. These may be preferable to growth rooms in that a close approximation to natural light conditions prevail, and precipitation enters the top of the chamber: However, wind is reduced and temperature is increased, thus, two of the main environmental factors considered to be of prime importance in determining the position of tree-lines are not well controlled and usually not measured.

A distinct advantage of artificial environments is that uniform soil conditions can easily be maintained. Although the use of pots of known soil content in the field provides a uniform start to plant growth it does not allow roots to expand naturally, nor water and nutrient status of the soil to be directly comparable with that surrounding the pot. This may be significant in long-term experiments where root growth may become restricted, nutrients may become limiting and soil may either dry out or be repeatedly waterlogged. In the current study some precautions were taken against these possibilities by removing the base of the pots and lowering them to the soil surface level.

In addition to the potted plants measurements were made on naturally-occurring native trees. For all measurements made on both sets of trees the results were more consistent along the transect for the native than the potted trees. As mentioned previously (chapter 2) this could be due to several factors. Firstly the potted trees were much younger than the native ones, being between 2 and 4 years old compared to 10 to 20 years, and therefore differences in growth and development with respect to age are likely. Secondly, the growth form of the trees was different as the native trees were larger and more bushy and had far more growing shoots, whereas the potted trees were comparatively small and had single, terminal shoots in which the majority of growth was concentrated. Thirdly, the soil, water and root restrictions imposed by the pots may have prevented the younger trees from exploiting their habitat to their best advantage. The older, native trees, without such restrictions, would have the advantage of time to establish root systems adapted to variations occurring along the transect.

### **(iii) Temperature and growth**

Temperature affects growth both directly and indirectly. Direct effects include those on cell division and expansion which involve temperature-sensitive metabolic processes. Cell division occurs in the meristematic tissue of the buds which develop during the summer preceding their expansion. Current year temperatures are therefore important determinants of the following years' shoot growth, in the case of *P. sylvestris* fascicle numbers and height extension. Further division plus cell expansion occur in the spring as the previous season buds develop (Sutcliffe,

1977). These processes are limited partly by temperature, particularly leaf expansion (needle elongation), where maximum growth occurs within an optimal range. In the current work the comparison of growth data recorded in the field with that in the greenhouses suggested that maximum growth took place under mean monthly temperatures (June and July) of between 10 and 21 °C and that above this range growth became limited.

The main indirect effect of temperature on growth is through photosynthesis. The extent of leaf development determines the potential photosynthetic surface area which can contribute towards further growth. Temperature also influences the rate of photosynthesis, increasing it within an optimal range between 15 and 25 °C (Lawlor, 1987). This range is within that found for *P. sylvestris*, a wider range having been suggested by Küppers *et al.* (1985 (unseen) cited by Schäfer and Krieger, 1991). Photosynthetic rate is known to be a function of both instantaneous temperature and to temperature in the preceding days. Under conditions of low temperature and bright light photochemical damage to the light-harvesting systems (photoinhibition) may occur (Lawlor, 1987). It is not possible to state the optimal temperature range for photosynthetic rates of *P. sylvestris* at Creag Fhiaclach from the results of the present study because measurements were made at only three widely-spaced time intervals and observed patterns created by the developmental stage of the needles obscured any responses due solely to temperature.

A previous study at this site (Grace and Norton, 1990) involved the correlation of monthly temperature and rainfall data with the width of annual growth rings from an altitudinal transect. Although this did not provide a quantitative measure of sensitivity it implied that not only is temperature more important than rainfall in determining ring-widths, but that late winter temperatures (January and February), especially at high altitudes, are particularly so. A suggestion for the cause of this relationship is that needle loss over winter is likely to reduce the radial growth increment during the following summer as a result of depleted potential photosynthetic surface area. It has been shown in the current study that the percentage of current year fascicles that survive from one year to the next varies significantly with altitude. Above the tree-line (675 m) less than 30% of needles on the native trees survived in either year of measurement and less than 60% at

most other stations. Therefore, a considerable loss of leaf area occurs which may be sufficient to restrict the total growth of the following season.

#### **(iv) The importance of nutrition**

Nitrogen and potassium were found in low concentrations in many of the needles sampled. In the case of the potted trees low concentrations were primarily attributed to restricted root development which limited plant nutrient uptake after the potted soil had become depleted of reserves. In comparison, the native trees were thought to have well-established root systems, a larger leaf and stem area for nutrient storage, and a slower rate of growth, and hence, nutrient demand.

Significant variation in nitrogen concentration was found with altitude for the needles from the native trees. Although low values were observed in February and May between 450 m and 580 m, the foliar concentrations remained relatively high above the tree-line and were higher than those of the valley trees throughout the season. These results may be related to greater atmospheric inputs of nitrogen at high elevation, particularly through cloud deposition. As the foliage of both the potted and native trees was more equally exposed to the air than the roots were to the surrounding soil, it is likely that low concentrations found in the potted trees were due to poor nutrient uptake ability of the roots. The larger storage capacity, size and age of the naturally-occurring trees (as mentioned earlier) could also have accounted for the differences observed.

Some forms of pollution-related tree decline result from an imbalance of atmospheric inputs. For example, Type 1 spruce decline in Germany is associated with yellowing of leaves and magnesium deficiency. The latter is said to arise from the relatively large atmospheric inputs of nitrogen, which stimulate canopy growth, while soil magnesium supply is limited (Schulze *et al.*, 1989). No evidence of tree decline was apparent in the form of low magnesium concentrations in any of the plants measured. In fact the amounts of magnesium were often found to be high and showed little variation with altitude. Some decreases in the concentrations of other nutrients were observed with respect to altitude and it is possible that these relate to a general trend of movement through the soil downslope by leaching processes.

#### **(v) Winter desiccation at Creag Fhiaclach**

It has already been noted that the percentage survival of needles overwinter from one year to the next represents a substantial loss from the plant in terms of both stored reserves and the potential photosynthetic surface area. However, it has been shown that this loss is not the result of poorly-developed cuticles which give inadequate protection against winter desiccation. A more likely cause of needle death at this site is through desiccation initiated by surface abrasion. The impaction of wind-blown particles, together with inter- and intra-plant surface contact during buffeting by air movement, can cause abrasion of epicuticular waxes and subsequent leaf damage. Since no significant relationship was found between cuticle weight per surface area and altitude, yet percentage needle survival decreased with increasing altitude it is thought that the effects of wind (mechanical, abrasive, reduced boundary layer resistance) are more important at this site than the length of the growing season available for cuticular maturation. Needle loss with respect to altitude is thought to be due chiefly to increasing wind-speeds with elevation and may be accelerated by seasonal climatic fluctuations, as indicated by the decrease in cuticular weight at all stations in October. It is therefore concluded that at Creag Fhiaclach variations observed in tree growth along the transect were not caused directly by cuticular differences. The emphasis given to cuticular development at alpine sites seems quite inappropriate to the conditions in this more oceanic environment.

#### **(vi) Some general considerations**

##### ***Adaptation to the tree-line environment***

In order to survive, adaptations to the surrounding habitat are necessary, and in regions where conditions are limiting to growth these are often highly specialised and efficient. The *krummholz* growth form frequently found above the true forest limit is probably the most distinct adaptation to this habitat. Characteristics include short, twisted stems and stunted growth with the appearance of low-growing scrub.

At Creag Fhiaclach it is not yet known whether these tree forms are phenotypically or genetically determined (Wilson *et al.*, 1987). Repeated damage caused by environmental factors acting on plant morphology may have been sufficient to have caused these forms to develop at this altitude and if these trees were transplanted to a lower elevation they may be found to increase in stature. Alternatively, *krummholz* individuals growing here may represent a distinct genetic population which should retain its characteristic growth in a less severe situation. An example of such a species is *Betula pubescens* var. *tortuosa* growing in Scandinavian timber-line birch forests which retain their stunted appearance even after transference to more favourable habitats (Crawford, 1989).

Although the term "*krummholz*" ("crooked wood") is often used to describe all stunted forms of the dominant tree species at tree-lines (as used in the present work), a distinction is sometimes made in which the term is only applied to those which are genetically determined (Holtmeier, 1981). Holtmeier (1981) suggested that the term "cripple trees" was adequate for the description of trees within the forest-tundra ecotone which are climatically-stunted but are not genetic dwarfs. Norton and Schönenberger (1984) consider the term "*krummholz*" inappropriate to the *Nothofagus* tree-lines in New Zealand and attribute deformed growth in these regions to environmental processes, namely winter desiccation and frost, and snow accumulation and movement. In Scotland the effects of snow are probably far less important at the natural tree-line than at those in more continental regions. Snow can act both against and in favour of tree survival depending on its depth and in relation to the size of the plants. Branches weighed down under accumulated snow may break thereby reducing leaf area and exposing the tree to desiccation and infection at the injured surface. Some depth of surface snow can provide protection, however, by insulating the soil and thus minimising the depth to which it freezes. Also by restricting the amount of water loss from buried branches and providing a surface from which covered foliage may absorb water (Marchand, 1987).

Desiccation has often been considered as a major factor limiting tree growth above the tree-line (Hansen and Klikoff, 1972; Wardle, 1968; Tranquillini, 1979) and the term "*Frostrockknis*" ("frost desiccation") is frequently used to describe the winter condition induced by frozen soils, wind and excess water loss, and characterised by a browning of the foliage in late winter and early spring.

To some extent the effects of desiccation are reduced by developing a low growth form as the aerodynamic resistance between the plant and its microenvironment is higher than it would be were the plant taller. This concept of "coupling" was proposed by Monteith (1981) and later the "omega factor" was introduced by Jarvis and McNaughton (1986), a decoupling factor that describes how closely the saturation deficit at the leaf surface is linked to that of the air outside the leaf boundary layer. However, by developing a form which provides the potential to maintain tissue temperatures above those of the surrounding air, rates of cell division and expansion may often be higher than in the tree form and any associated risks may ensue. As a result of an elevated surface temperature in bright sunshine, the likelihood of desiccation could be heightened in continental regions of high irradiation and frozen soils through excess evapotranspiration. This aspect of mountain vegetation probably deserves more attention.

Whatever the causes of the development of the dwarf growth habit above the tree-line the trees found here are extremely well adapted to their environment in being able to withstand the adverse conditions which taller forms of the same species are unable to tolerate. By exploiting this region through such adaptations tree-line dominants extend their natural range to the limits of their survival.

#### **(vii) Relevance of the study**

The present study is concerned chiefly with the natural altitudinal limit of the native pine in Scotland and hence, to some extent, may only be relevant within this area, to the rest of Britain and for the current knowledge about this species. However, all these are important aspects and the significance of the study site alone, as a relict natural tree-line, warrants investigation.

Today the native pinewoods of Scotland represent part of an ancient natural forest which was once extensive across the country. They are unique, undisturbed, diverse habitats of prime conservation value and are an outstanding feature of the natural heritage of Britain.

The lack of past management at Creag Fhiaclach has created ideal natural conditions for scientific field experiments by eliminating the majority of effects resulting from human interference. The present work has provided an insight to some aspects of the growth of *P. sylvestris* at a range of altitudes largely with respect to temperature. Although these relationships may not be equivalent to those in other regions of Scotland they are likely to be of direct value as a baseline for native pinewoods of similar composition.

Perhaps the most important results obtained were the growth increment variations between the measurement stations. From these, some idea can be gained as to the amount of development this species is likely to undergo at a given temperature or altitude in a comparable situation. This has implications for the future management of native pinewoods by providing information on the possible performance of trees in relation to local climate variations or modifications and may therefore be of use, for example during planting considerations.

The limitations of the study include the lack of soil measurements. It was unfortunate that no data on the depth and duration of soil freezing were obtained particularly at the tree-line where restriction of access to soil water may be of significance (refer to section i). In the case of the naturally-occurring trees the nutrient content of the soil may also be important and may vary along the transect. The availability of nutrients to the roots could involve a physiological adaptation, the extent of which may relate to altitude.

To some extent microclimatic effects were taken into account. This was true for the potted trees where size, age and soil effects were reduced and temperature measurements were made on the plants themselves. In this way any relationships found could be applied to *P. sylvestris* (of the same provenance) growing elsewhere. However, climatic factors may influence long-term growth patterns between regions along an altitudinal transect on a larger scale. Quantitative values of precipitation loads, run-off and percolation may reveal links which emphasise the current suggestions for observed differences along a hillside and thereby strengthen conclusions made. The mechanical effect of wind also varies between geographical locations and with the degree of exposure and provision of shelter. The results of the present work could be used in predictions of future survival and

the success of the species at other comparable sites. The accuracy of such predictions would clearly be enhanced if data on these variables were obtained.

On a European scale the relevance of this study is probably linked more closely to the relationship found between growth and the length of the growing season. Even over an altitudinal distance of less than 700 m differences were observed in the onset, duration and cessation of some physiological processes. For *P. sylvestris* values obtained, eg. the time lag in needle extension of the trees at higher elevations behind those growing at lower stations, may be applicable to other regions. Although such information may not be directly transferable to other sites, the values nevertheless contribute to the current information available on this species and could be used in the construction of models to predict growth patterns over a range of temperatures.

#### **(viii) Predictions for the future**

If global warming continues at its present rate temperatures are likely to increase by 3 °C before the end of the next century (Haughton *et al.*, 1990). Changes in wind and precipitation patterns may also occur which together with temperature would affect soil moisture and plant growth. As plants respond and adapt to their surrounding environment they also contribute to climatic changes. An increase in atmospheric carbon dioxide may stimulate photosynthesis and increase water- and nutrient-use efficiency. In this way the amount of stored carbon may increase through stimulation of woody growth. However, at higher temperatures respiration may increase and lead to an initial net release of carbon to the atmosphere (Melillo *et al.*, 1990).

Many models simulating climate change and its effect on forest systems have been created. From these it has been predicted that greater warming is likely at high latitudes than at the equator. In one model (FORENA - a forest stand simulation model) the simulated dieback within deciduous-coniferous transition areas (assuming climate to change at a constant rate as atmospheric CO<sub>2</sub> doubles) was indistinct in southern regions but clear in northern ones (Solomon, 1986). From the same model, results indicated that the replacement of boreal conifers by deciduous hardwoods would be slower in the north than the south and also that

transient responses in species composition and carbon storage may continue for up to 300 years after the climatic change. Results using a "forest productivity - soil process" model with similar climatic assumptions showed the greatest changes in north-eastern North American forests to occur at the boreal/cool temperate forest border (Pastor and Post, 1988). The simulated forest responses in this case were concluded to be

"..results of a positive feedback between carbon and nitrogen cycles, bounded by negative constraints of soil moisture availability and temperature."

Some of the values obtained in the current work could be used to estimate possible growth responses of *P. sylvestris* at Creag Fhiaclach with respect to climatic temperature change. The best values to use in this type of estimate would probably be the environmental lapse rates of the main growth months together with the calculated maximum growth rates. Lapse rates could be used to determine the likely elevational displacement necessary to experience a given temperature change. An estimate of the subsequent change in growth rate could then be obtained using the current values measured at the "new" altitude. For example, in 1989 the lapse rates in May and June were  $-9.2\text{ }^{\circ}\text{C km}^{-1}$ . The maximum height growth rates of the naturally-occurring trees over this time decreased with increasing altitude from  $4.83$  to  $1.60\text{ mm week}^{-1}$ . If temperatures increased by  $2\text{ }^{\circ}\text{C}$  the mean air temperatures at the highest station ( $675\text{ m}$ ) might become similar to those  $217\text{ m}$  lower ( $458\text{ m}$ ), ie. close to those at station 4 ( $450\text{ m}$ ). As a result the maximum height growth rate might be expected to increase from  $1.6\text{ mm week}^{-1}$  to approximately  $3.0\text{ mm week}^{-1}$ . However, it should be noted that by the same method not all plants would be predicted to increase their growth rates after such a displacement to a lower elevation. In several cases the growth rates measured did not decrease between all stations along the transect. Above the tree-line increases were observed between  $580\text{ m}$  and  $675\text{ m}$  and therefore an estimate of the change in the rate of needle extension, for example, would be a decrease of  $-0.25\text{ mm week}^{-1}$  for plants growing at  $675\text{ m}$ .

Clearly this type of prediction is over-simplistic and does not take account of the change in lapse rate with altitude. It is also based on air temperatures rather than meristem temperatures, the latter having been shown to fluctuate on either side of

the former (chapter 2). However, the basic outcome of these calculations is an overall view of the probable direction of change in growth rate.

A decrease in growth rates following an increase in air temperature may reflect the speed of adaptation of the species at extremes of altitude. The higher rate prior to the temperature increase could have been an adaptation for completion of growth within the limited growth season. After warming, the length of the season would no longer be as limiting and growth rates may slow as a result. Alternatively, a decrease in rate could be due to a poor capacity to adapt to temperature change since higher temperatures would be expected to promote more rapid growth. For northern provenances of *P. sylvestris* seedlings grown in natural light under controlled temperatures the shoot elongation period has been shown to decrease and the rate of growth increase as current season temperatures increase (Junttila, 1986).

The number of needle fascicles produced would also be expected to increase under higher temperatures as would the total needle length and hence, plants would increase their total leaf area and potential for photosynthesis. An increase in photosynthetic production would result in further growth through positive feedback.

When considering the possibility of a change in climate, interspecific interactions should not be overlooked. At this site the *Calluna* community would also be likely to undergo growth fluctuations. Since the height of *Calluna* plants has been observed to decrease with altitude at this site it is likely that an increase in temperature here would cause an altitudinal shift in plant size and production comparable to that suggested for *P. sylvestris*. Initially competition for light might occur between the two species if pine seedlings were outgrown by the heather plants and became shaded. Competitive growth rates might determine the survival of previously established trees, especially those above the tree-line where their height advantage would be less than at lower altitudes. Establishment of new seedlings at elevations above the present distribution could be possible under warmer temperatures although timing could be critical because enhanced *Calluna* growth, whilst providing shelter and some protection from grazing, may form a more dense canopy and restrict the amount of light reaching the soil surface. More vigorous growth at high altitudes would deplete already limited soil nutrient

reserves (although an increase in soil temperatures could accelerate nutrient release through increased microbial activity) and may result in competition for space. If this occurred some thinning of the vegetation may take place and result in fewer, stronger individual plants surviving. The importance of the competitive power of ground vegetation has been observed for subalpine tree life in the Swiss Alps (Turner *et al.*, 1982).

All speculations so far in this section were made under the assumption that a temperature rise would affect all altitudes equally and would result in a straightforward shift of present growth to higher elevations by approximately 100 m for each degree raised. Changes in topography and in the effect of the vegetation on the local climate are important factors which would cause deviations from this relationship and which are probably the main determinants of the altitudinal "step" observed either side of the tree-line in several of the results. Long-term data are necessary to make valid predictions about future change.

The results of air temperature measurements in this study showed fluctuations in monthly lapse rates even between two consecutive years. Invasion of the site by species which are currently absent, or in very low numbers, is possible and has not been considered. The effects of grazing, which have been incorporated to some extent by recording needle and plant survival, could increase, particularly by invertebrates, as higher temperatures might allow species to extend their range altitudinally.

Whatever changes and interactions occurred the effects on the growth of *P. sylvestris* would be most pronounced at the upper limit of its current distribution. Here, the plants are adapted to certain environmental characteristics distinct from those even a few hundred metres lower. If changes disrupted this relationship the plants' adaptation may no longer be suitable for the microenvironment. Rapid adaptability during change would therefore be essential for the continued success of pine in this area.

### **(ix) Suggestions for further work**

Possible further work relating to the present study other than the collection of similar data over a longer period to obtain an estimation of long-term means, would include measurements of factors omitted and further information on those investigated. Information of the soil properties upslope, downslope and of the area surrounding the naturally-occurring pines may be useful. Values of nutrient and water content and any patterns in these with distance or altitude from individual plants could aid the interpretation of plant nutrient and water status. By sampling soils above and below the root area along an altitudinal transect an idea of the leaching processes taking place at this site and the soil-plant interactions involved might be obtained. Measurements of root growth (such as those made by Turner *et al.*, (1982)) and the area to which the roots extend from the stem may stimulate suggestions for the causes of above-ground growth patterns and could indicate the extent of below-ground limitations. The methods involved in this type of sampling would be destructive, or at very least perturbing, and it is not likely that permission would be granted at this site in order to undertake them. Although below-ground processes may be of major importance in the determination of the position of the tree-line at Creag Fhiaclach the scope for data on the existing trees is limited in comparison with that which could be obtained from potted seedlings or larger trees which could be harvested.

The establishment of soil-freezing experiments in a greenhouse or growth room could be used to gain information on needle and plant survival at a range of prolonged, low root temperatures. Studies of this type may enable sensitivity ranges of winter browning of needles to be identified. Some investigation of mycorrhizal associations with respect to altitude would also be of interest.

Further investigation of the extent of leaf damage could be obtained by fluorescence analysis. This technique could provide information on the photochemical efficiency of trees subjected to a range of air and soil fluctuations. It could be used in connection with soil-freezing experiments under a range of light regimes to estimate the importance of photoinhibition at this site in winter.

A long-term study on the population dynamics of Scots pine at this tree-line and in the valley below could help to explain some of the current results. The

construction of a static life table for each population (notably those on which measurements of photosynthesis were made) would provide an extra form of comparison between the trees of these two areas. Results could then be compared with those obtained by Grace and Norton (1990) on tree age along an altitudinal transect and those by Pears (1988) on the age structure of the seedling population over the last 30 years.

The conclusions listed at the end of chapters 2 to 5 remain as stated. The overall view obtained from the current work is one of adaptation by a single species to its microenvironment and the extent to which this varies with altitude. The following concluding statement made by Ford and Milne (1981) on the subject of plants and their atmospheric environment summarises the complexity involved in this type of study;

"Both weather and plant growth are dynamic systems varying over time in such a way that component processes are constantly changing in their rate of activity."

The future patterns of change in the growth of Scots pine at Creag Fhiaclach will ultimately be determined by human impact. Pressures acting upon the site and the surrounding area include political as well as environmental ones. Future legislation on local land use and access together with local and largescale pollution and erosion effects are involved. Changes resulting from such effects could determine the future existence of the native pine as an ancient relict in Scotland.

## REFERENCES

- Anonymous (1991)** *Climate Change: A report to the FRCC by the Review Group* (unpublished, Forestry Commission, Penicuik).
- Baig, M.N. and Tranquillini, W. (1976)** Studies on upper timberline: morphology and anatomy of Norway spruce (*Picea abies*) and stone pine (*Pinus cembra*) needles from various habitat conditions. *Canadian Journal of Botany* **54**:1622-1632.
- Baker, E.A. (1974)** The influence of environment on leaf wax development in *Brassica oleracea* var. *gemmifera*. *New Phytologist* **73**:955-966.
- Bamberg, S., Schwarz, W. and Tranquillini, W. (1967)** Influence of daylength on the photosynthetic capacity of stone pine (*Pinus cembra* L.). *Ecology* **48**(2):264-269.
- Barclay, A.M. and Crawford, R.M.M. (1984)** Seedling emergence in the rowan (*Sorbus aucuparia*) from an altitudinal gradient. *Journal of Ecology* **72**:627-636.
- Barry, R.G. and Chorley, R.J. (1968)** *Atmosphere, Weather and Climate*. Methuen & Co. Ltd., London.
- Beadle, C.L., Neilson, R.E., Talbot, H. and Jarvis, P.G. (1985a)** Stomatal conductance and photosynthesis in a mature Scots pine forest; I. Diurnal, seasonal and spatial variation in shoots. *Journal of Applied Ecology* **22**:557-571.
- Beadle, C.L., Neilson, R.E., Talbot, H. and Jarvis, P.G. (1985b)** Stomatal conductance and photosynthesis in a mature Scots pine forest; II. Dependence on environmental variables of single shoots. *Journal of Applied Ecology* **22**:557-571.

- Benecke, U. and Havranek, W.M. (1980)** Gas exchange of trees at altitudes up to timberline, Craigieburn Range, New Zealand. In: *Mountain Environments and Subalpine Tree Growth*. (Eds.) U. Benecke and M.R. Davies. *New Zealand Forest Service Technical Paper 70*:195-210.
- Binns, W.O., Mayhead, G.J. and MacKenzie J.M. (1980)** *Nutrient Deficiencies of Conifers in British Forests*. Forestry Commission Leaflet 76, H.M.S.O..
- Birks, H.H. (1972)** Studies in the vegetational history of Scotland; III A radiocarbon-dated diagram from Loch Maree, Ross and Cromarty. *New Phytologist 71*:731-754
- Birks, H.H. (1975)** Studies in the vegetational history of Scotland; IV Pine stumps in Scottish blanket peats. *Philosophical Transactions of the Royal Society B270*:181-226.
- Birks, H.J.B. (1989)** Holocene isochrone maps and patterns of tree-spreading in the British Isles. *Journal of Biogeography 16*:503-540.
- Bourdeau, P.F. (1959)** Seasonal variation of the photosynthetic efficiency of evergreen conifers. *Ecology 40*(1):63-67.
- Bridge, M.C., Haggart, B.A. and Lowe, J.J. (1990)** The history and palaeoclimatic significance of subfossil remains of *Pinus sylvestris* in blanket peats from Scotland. *Journal of Ecology 78*:77-79
- Brimblecombe, P. and Stedman, D.H. (1982)** Historical evidence for a dramatic increase in the nitrate component of acid rain. *Nature 298*:460-462.
- Burgess, J. (1985)** *An Introduction to Plant Cell Development*. Cambridge University Press, Cambridge.
- Caldwell, M.M. (1968)** Solar ultraviolet radiation as an ecological factor for alpine plants. *Ecological Monographs 38*:243-268

- Cannell, M.G.R. (1974)** Production of branches and foliage by young trees of *Pinus contorta* and *Picea sitchensis*: provenance differences and their simulation. *Journal of Applied Ecology* 11:1091-1115.
- Cannell, M.G.R., Grace, J. and Booth, A. (1989)** Possible impacts of climatic warming on trees and forests in the United Kingdom: a review. *Forestry* 62(4):337-364.
- Cannell, M.G.R., Thompson, S. and Lines, R. (1976)** An analysis of inherent differences in shoot growth within some north temperate conifers. In: *Tree Physiology and Yield Improvement*. pp.173-205. (Eds.) M.G.R. Cannell and F.T. Last. Academic Press, London.
- Carlisle, A. and Brown, H.F. (1968)** Biological flora of the British Isles; *Pinus sylvestris* L.. *Journal of Ecology* 56:269-307.
- Clark, J.B. and Lister, G.R. (1975)** Photosynthetic action spectra of trees: II. The relationship of cuticle structure to the visible and ultraviolet spectral properties of needles from four coniferous species. *Plant Physiology* 55:407-413
- Crawford, R.M.M. (1982)** Habitat specialisation in plants of cold climates. *Transactions of the Botanical Society of Edinburgh* 44(1):1-12.
- Crawford, R.M.M. (1989)** *Studies in Plant Survival; Ecological case histories of plant adaptation to adversity*. Blackwell Scientific, Oxford.
- Crossley, A. and Fowler, D. (1986)** The weathering of Scots pine epicuticular wax in polluted and clean air. *New Phytologist* 103:207-218.
- Dahl, E. (1990)** Probable effects of climatic change due to the greenhouse effect on plant productivity and survival in North Europe. In: *Effects of climate change on terrestrial ecosystems*. Report from a seminar in Trondheim 16.01.1990 *Norsk Institutt For Naturforskning* 4:7-18.

- Dallimore, W. and Jackson, A. (1966)** *A Handbook of Coniferae and Ginkgoaceae*. Arnold, London.
- Daubenmire, R. (1954)** Alpine timberlines in the Americas and their interpretation. *Butler University Botanical Studies* 2:119-136.
- Davies, C.E. and Benecke, U. (1980)** Fluidized bed coating of conifer needles with glass beads for determination of leaf surface area. *Forest Science* 26(1):29-32.
- Davis, D.G. (1971)** Scanning electron microscopic studies of wax formations on leaves of higher plants. *Canadian Journal of Botany* 49:543-546.
- Dollard, G.J., Unsworth, M.H. and Harve, M.J. (1983)** Pollutant transfer in upland regions by occult precipitation. *Nature* 302:241-243.
- Drew, A.P. and Running, S.W. (1975)** Comparison of two techniques for measuring surface area of conifer needles. *Forest Science* 21:231-232.
- Ericsson, A. (1978)** Seasonal changes in translocation of  $^{14}\text{C}$  from different age-classes of needles on 20-year-old Scots pine trees (*Pinus sylvestris*). *Physiologia Plantarum* 43:351-358.
- Ericsson, A., Lindgren, A. and Mattsson, A. (1984)** Effects of cold storage and planting date on subsequent growth, starch and nitrogen content in Scots pine (*Pinus sylvestris*) and Norway spruce (*Picea abies*) seedlings. *Studie Forestalia Suecia* 165.
- Ford, E.D. and Milne, R. (1981)** Assessing plant response to the weather. In: *Plants and their Atmospheric Environment*. pp. 333-362. (Eds.) J. Grace, E.D. Ford and P.G. Jarvis. Blackwell Scientific Publications, London.
- Fowler, D., Cape, J.N., Leith, I.D., Paterson, I.S., Kinnaird, J.W. and Nicholson, I.A. (1982)** Rainfall acidity in northern Britain. *Nature* 297:383-386.

- Fowler, D., Cape, J.N. and Unsworth, M.H. (1989)** Deposition of atmospheric pollutants on forests. *Philosophical Transactions of the Royal Society of London*. **B324**:247-265.
- Fife, D.N. and Nambiar, E.K.S. (1984)** Movement of nutrients in radiata pine needles in relation to the growth of shoots. *Annals of Botany* **54**:303-314.
- Gates, D.M. (1990)** Climate change and the response of forests. *International Journal of Remote Sensing* **11(7)**: 1095-1107.
- Geyer, U. and Schönherr, J. (1990)** The effect of the environment on the permeability and composition of *Citrus* leaf cuticles. *Planta* **180**:147-153.
- Gordon, J.C. and Larson, P.R. (1968)** Seasonal course of photosynthesis, respiration and distribution of <sup>14</sup>C in young *Pinus resinosa* trees as related to wood formation. *Plant Physiology* **43**:1617-1624.
- Grace, J. (1977)** *Plant Response to Wind*. Academic Press, London.
- Grace, J. (1981)** Some effects of wind on plants. In: *Plants and their Atmospheric Environment*. pp.31-56. (Eds.) J. Grace, E.D. Ford and P.G. Jarvis. Blackwell Scientific Publications, Oxford.
- Grace, J. (1983)** *Plant-Atmosphere Relationships*. Outline studies in Ecology. Chapman and Hall, London.
- Grace, J. (1987)** Climatic tolerance and the distribution of plants. *New Phytologist* **106(Suppl.)**: 113-130.
- Grace, J. (1989)** Tree lines. *Philosophical Transactions of the Royal Society of London*. **B324**:233-245.
- Grace, J. (1990)** Cuticular water loss unlikely to explain tree-line in Scotland. *Oecologia* **84**:64-68.

- Grace, J. and Norton, D.A. (1990)** Climate and growth of *Pinus sylvestris* at its upper altitudinal limit in Scotland: evidence from tree growth-rings. *Journal of Ecology* **78**:601-610.
- Grace, J. and Unsworth, M.H. (1988)** Climate and microclimate of the uplands. In: *Ecological Change in the Uplands*.pp.137-150. Special Publication (Eds.) M.B. Usher and D.B.A. Thompson. Blackwell Scientific Publications, Oxford.
- Grammeltvedt, A. (1990)** Climate change in Norway due to increased greenhouse effect. In: *Effects of climate change on terrestrial ecosystems*. Report from a seminar in Trondheim 16.01.1990 *Norsk Institutt For Naturforskning* **4**:6-7.
- Green, F.H.W. (1981)** Climate and Weather. In: *The Cairngorms; Their Natural History and Scenery*.pp.228-236. (Eds.) D. Nethersole-Thompson and A. Watson. Melven Press, Perth.
- Hadley, J.L. and Smith, W.K. (1986)** Wind effects on needles of timberline conifers: seasonal influence on mortality. *Ecology* **67**(1):12-19.
- Hansen, D.H. and Klikoff, L.G. (1972)** Water stress in *krummholz*, Wasatch Mountains, Utah. *Botanical Gazette* **133**(4):392-394.
- Häsler, R. (1982)** Net photosynthesis and transpiration of *Pinus montana* on east and north facing slopes at alpine timberline. *Oecologia* **54**:14-22.
- Häsler, R. (1985)** CO<sub>2</sub> uptake in European larch (*Larix decidua* Mill.) near treeline in Switzerland (Stillberg/Davos). In: *Establishment and Tending of Subalpine Forest: Research and Management*. Proceedings of 3rd IUFRO Workshop 1984, *Eidgenoessische anstalt fuer das forstliche versuchswesen*, pp.113-122. (Eds.) H. Turner and W. Tranquillini. Berlin.
- Houghton, J.T., Jenkins, G.J. and Eupraums, J.J. (1990)** *Climate Change*. IPCC Scientific Assessment. Cambridge University Press, Cambridge. (see Melillo *et al.*, 1990)

- Helmisaari, H-S. (1990)** Temporal variation in nutrient concentrations of *Pinus sylvestris* needles. *Scandinavian Journal of Forest Research* 5:177-193.
- Herbin, G.A. and Robins, P.A. (1968)** Studies on plant cuticular waxes. III. The leaf wax alkanes and -hydroxy acids of some members of the Cupressaceae and Pinaceae. *Phytochemistry* 7:1325-1337.
- Holtmeier, F-K. (1981)** What does the term "krummholz" really mean? Observations with special reference to The Alps and the Colorado Front Range. *Mountain Research and Development* 1(3-4):253-260.
- Hunneman, D.H. and Eglinton, G. (1972)** The constituent acids of gymnosperm cuticles. *Phytochemistry* 11:1989-2001.
- Huntley, B. (1990)** European post-glacial forests: compositional changes in response to climatic change. *Journal of Vegetation Science* 1:507-518.
- Huntley, B. and Birks, H.J.B. (1983)** *An atlas of past and present pollen maps for Europe: 0-13,000 years ago*. Cambridge University Press, Cambridge.
- Hustich, I. (1947)** Climatic fluctuations and vegetation growth in northern Finland during 1890-1939. *Nature* 160:478-479.
- Innes, J.L. (1987)** *Air Pollution and Forestry*. Forestry Commission Bulletin No.70. HMSO, London.
- Jarvis, P.G. (1981)** Stomatal conductance, gaseous exchange and transpiration. In: *Plants and their Atmospheric Environment* pp.175-204. (Eds.) J. Grace, E.D. Ford and P.G. Jarvis. Blackwell Scientific Publications, Oxford.
- Jarvis, P.G. and Jarvis, M.S. (1963)** The water relations of tree seedlings. IV. Some aspects of the tissue water relations and drought resistance. *Physiologia Plantarum* 16: 501-516.

- Jarvis, P.G. and McNaughton, K.G. (1986)** Stomatal control of transpiration: scaling up from leaf to region. *Advances in Ecological Research* **15**:1-49.
- Jeffree, C.E. (1986)** The cuticle, epicuticular waxes and trichomes of plants, with reference to their structure, functions and evolution. In: *Insects and the Plant Surface*. pp.23-64. (Eds.) B. Juniper and R. Southwood. Arnold, London.
- Jeffree, C.E., Baker, E.A. and Holloway, P.J. (1976)** Origins of the fine structure of plant epicuticular waxes. In: *Microbiology of Aerial Plant Surfaces*. pp.119-158. (Eds.) C.H. Dickinson and T.F. Preece. Academic Press, London.
- Juniper, B.E. and Jeffree, C.E. (1983)** *Plant Surfaces*. Edward Arnold, London.
- Junttila, O. (1986)** Effects of temperature on shoot growth in northern provenances of *Pinus sylvestris* L.. *Tree Physiology* **1**:185-192.
- Junttila, O. and Heide, O.M. (1981)** Shoot and needle growth in *Pinus sylvestris* as related to temperature in Northern Fennoscandia. *Forest Science* **27(3)**: 423-430.
- Kaufmann, M.R. (1968)** Water relations of pine seedlings in relation to root and shoot growth. *Plant Physiology* **43**:281-288.
- Kajimoto, T. (1990)** Photosynthesis and respiration of *Pinus pumila* needles in relation to needle age and season. *Ecological Research* **5**:333-340.
- Kearney, M.S. and Luckman, B.H. (1983)** Holocene timberline fluctuations in Jasper National Park, Alberta. *Science* **221**:261-262.
- Kinloch, B.B., Westfall, R.D. and Forrest, G.I. (1986)** Caledonian Scots pine: origins and genetic structure. *New Phytologist* **104**:703-729.
- Kolattukudy, P.E. (1981)** Structure, biosynthesis, and biodegradation of cutin and suberin. *Annual Review of Plant Physiology* **32**:539-567.

- Köppen, W. (1931)** *Grundriss der Klimakunde*. De Gruyter, Berlin.
- Körner, Ch. and Cochrane, P. (1983)** Influence of plant physiognomy on leaf temperature on clear midsummer days in the Snowy Mountains, south-eastern Australia. *Acta Oecologica/Oecologia Plantarum* **4(18)No.2**:117-124.
- Körner, Ch. and Mayr, R. (1981)** Stomatal behaviour in alpine plant communities between 600 and 2,600 metres above sea level. In: *Plants and their Atmospheric Environment*. pp.205-218. (Eds.) J. Grace, E.D. Ford and P.G. Jarvis. Blackwell Scientific Publications, Oxford.
- Kramer, P.J. (1962)** The role of water in tree growth. In: *Tree Growth*. pp.171-182. (Ed.) T.T. Kozlowski. Ronald Press Company, New York.
- Kullman, L. (1980)** Radiocarbon dating of subfossil Scots pine (*Pinus sylvestris* L.) in the southern Swedish Scandes. *Boreas* **9**:101-106.
- Kullman, L. (1988)** Holocene history of the forest-alpine tundra ecotone in the Scandes Mountains (central Sweden). *New Phytologist* **108**:101-110.
- Larcher, W. (1980)** *Physiological Plant Ecology* 2nd Ed. Springer-Verlag, Berlin.
- Lawlor, D.W. (1987)** *Photosynthesis: Metabolism, Control and Physiology*. Longman Scientific and Technical, Harlow, Essex.
- Lee, B. and Priestley, J.H. (1924)** The plant cuticle: I. Its structure, distribution and function. *Annals of Botany* **38**:525-545.
- Lendzian, K.J., Nakajima, A. and Ziegler, H. (1986)** Isolation of cuticular membranes from various conifer needles. *Trees* **1**:47-53.
- Lockwood, J. (1974)** *World Climatology; An environmental approach*. Arnold, London.

- Long, S.P. and Hallgren, J-E. (1985)** Measurement of CO<sub>2</sub> assimilation by plants in the field and the laboratory. In: *Techniques in Bioproductivity and Photosynthesis*. pp.62-94. (Eds.) J. Coombs, D.O. Hall, S.P. Long and J.M.O. Scurlock Second edition, Pergamon Press, Oxford.
- Ludlow, M.M. and Jarvis, P.G. (1971)** Photosynthesis in Sitka spruce (*Picea sitchensis* (Bong.) Carr.): I. General characteristics. *Journal of Applied Ecology* **8**:925-953.
- McCracken, I.J., Wardle, P., Benecke, U. and Buxton, R.P. (1985)** Winter water relations of tree foliage at timberline in New Zealand and Switzerland. In: *Establishment of Tending Subalpine Forest: Research and Management*. pp.85-93. Proceedings of 3rd IUFRO Workshop 1984, Eidgenoessische anstalt fuer das forstliche versuchswesen, pp.85-93. (Eds.) H. Turner and W. Tranquillini. Berlin.
- McVean, D.N. (1963)** Ecology of Scots pine in the Scottish Highlands. *Journal of Ecology* **51**:671-686.
- Malcolm, D.C., Bradbury, I.K. and Freezaillah, B.C.Y. (1977)** The loss of nutrients from fertilized peat in an artificial system in the field. *Forest Ecology and Management* **1**:109-118.
- Marchand, P.J. (1987)** *Life in The Cold*. University Press of New England, Hanover.
- Martin, J.T. and Juniper, B.E. (1970)** *The Cuticles of Plants*. Edward Arnold, London.
- Martin, J.T. and Öquist, G. (1979)** Seasonal and experimentally induced changes in the ultrastructure of chloroplasts of *Pinus sylvestris*. *Physiologia Plantarum* **46**:42-49.
- Melillo, J.M., Callaghan, T.V., Woodward, F.I., Salati, E. and Sinha, S.K. (1990)** Effects on ecosystems. In: *Climate Change*.pp. IPCC Scientific Assessment.

- Mikola, P. (1962)** Temperature and tree growth near the northern timber line. In: *Tree Growth*. pp.265-274. (Ed.) T.T.Kozlowski. Ronald Press, New York.
- Miller, G.R. and Cummins, R.P. (1982)** Regeneration of Scots pine *Pinus sylvestris* at a natural tree-line in the Cairngorm Mountains, Scotland. *Holarctic Ecology* 5:27-34.
- Miller, H.G., Miller, J.D. and Cooper, J.M. (1981)** Optimum foliar nitrogen concentration in pine and its change with stand age. *Canadian Journal of Forest Research* 11:563-572.
- Milthorpe, F.L. and Moorby, J. (1979)** *An Introduction to Crop Physiology*. Second Edition. Cambridge University Press.
- Mitchell, A. and Wilkinson, J. (1982)** *The Trees of Britain and Northern Europe*. Collins, London.
- Monteith, J.L. (1981)** Coupling of plants to the atmosphere. In: *Plants and their Atmospheric Environment*. pp.1-29. (Eds.) J. Grace, E.D. Ford and P.G. Jarvis. Blackwell Scientific Publications, Oxford.
- Murray, M.B., Cannell, M.G.R. and Smith, R.I. (1989)** Date of budburst of fifteen tree species in Britain following climatic warming. *Journal of Applied Ecology* 26:693-700.
- Neilson, R.E., Ludlow, M.M. and Jarvis, P.G. (1972)** Photosynthesis in Sitka spruce (*Picea sitchensis* (Bong.) Carr.). II. Response to temperature. *Journal of Applied Ecology* 9:721-745.
- Nethersole-Thompson, D. and Watson, A. (1981)** *The Cairngorms; Their Natural History and Scenery*. Melven Press, Perth.
- Norton, D.A. (1984)** Phenological growth characteristics of *Nothofagus solandri* trees at three altitudes in the Craigieburn Range, New Zealand. *New Zealand Journal of Botany* 22:413-424.

- Norton, D.A. and Schönenberger, W. (1984)** The growth forms and ecology of *Nothofagus solandri* at the alpine timberline, Craigieburn Range, New Zealand. *Arctic and Alpine Research* **16(3)**:361-370.
- Oker-Blom, P. (1985)** Photosynthesis of a Scots pine shoot: simulation of the irradiance distribution and photosynthesis of a shoot in different radiation fields. *Agricultural and Forest Meteorology* **34**:31-40.
- Öquist, G., Brunes, L., Hallgren, J-E., Gezelius, K., Hallen, M. and Malmberg, G. (1980)** Effects of artificial frost hardening and winter stress on net photosynthesis, photosynthetic electron transport and RuBP carboxylase activity in seedlings of *Pinus sylvestris*. *Physiologia Plantarum* **48**:526-531.
- Öquist, G. and Huner, N.P.A. (1991)** Effects of cold acclimation on the susceptibility of photosynthesis to photoinhibition in Scots pine and in winter and spring cereals: a fluorescence analysis. *Functional Ecology* **5**:91-100.
- Öquist, G. and Martin, B. (1980)** Inhibition of photosynthetic electron transport and formation of inactive chlorophyll in winter stressed *Pinus sylvestris*. *Physiologia Plantarum* **48**:33-38.
- Orgell, W.H. (1955)** The isolation of plant cuticle with pectic enzymes. *Plant Physiology* **30**:78-80.
- Parker, J. (1961)** Seasonal trends in carbon dioxide absorption, cold resistance, and transpiration of some evergreens. *Ecology* **42**:(2)372-380.
- Pastor, J. and Post, W.M. (1988)** Response of northern forests to CO<sub>2</sub> induced climate change. *Nature* **334**:55-58.
- Pears, N.V. (1967)** Present tree-lines of the Cairngorm Mountains. *Journal of Ecology* **55**:815-829.

- Pears, N.V. (1968)** The natural altitudinal limit of forest in the Scottish Grampians. *Oikos* **19**:71-80.
- Pears, N.V. (1988)** Scots pine (*Pinus sylvestris*) seedling survival above the Tree-line in the Cairngorm Mountains, Scotland. *Forestry* **61**(1):61-71.
- Pelkonen, P. and Hari, P. (1980)** The dependence of the springtime recovery of CO<sub>2</sub> uptake in Scots pine on temperature and internal factors. *Flora* **169**:398-404.
- Pitcairn, C.E.R., Fowler, D. and Grace, J. (1991)** *Changes in species composition of semi-natural vegetation associated with the increase in atmospheric inputs of nitrogen*. ITE (NERC) Report to Nature Conservancy Council, Penicuik.
- Poore, M.E.D. and McVean, D.N. (1957)** A new approach to Scottish mountain vegetation. *Journal of Ecology* **45**:401-439.
- Powles, S.B. (1984)** Photoinhibition of photosynthesis induced by visible light. *Annual Review of Plant Physiology* **35**:15-44.
- Pravdin, L.F. (1969)** *Scots Pine; Variation, Intraspecific Taxonomy and Selection*. Translated from Russian, Jerusalem. *Academy of Sciences of the U.S.S.R.*
- Riederer, M. (1989)** The cuticles of conifers: structure, composition and transport properties. In: *Forest decline and air pollution: a study of spruce (Picea abies) on acid soils*. pp.157-192. (Eds.) E-D Schulze, O.L. Lange and R. Oren. Ecological Studies Vol.77, Springer-Verlag, Berlin.
- Riederer, M. and Schönerr, J. (1988)** Development of plant cuticles: fine structure and cutin composition of *Clivia miniata* Reg. leaves. *Planta* **174**:127-138.
- Rorison, I.H., Sutton, F. and Hunt, R. (1986)** Local climate, topography and plant growth in Lathkill Dale NNR. I. A twelve-year summary of solar radiation and temperature. *Plant, Cell and Environment* **9**:49-56.

- Ross, G.J.S. (1981)** The use of non-linear regression methods in crop modelling. In: *Mathematics and Plant Physiology* pp.269-282. (Eds.) D.A. Rose and D.A. Charles-Edwards. Academic Press, London.
- Rutter, A.J. (1957)** Studies in the growth of young plants of *Pinus sylvestris* L.. I. The annual cycle of assimilation and growth. *Annals of Botany* **21**:399-425.
- Schäfer, H. and Krieger, H. (1991)** Data set for the European Pine Model. Unpublished Proceedings of the Forest Ecosystems Research Network, European Science Foundation, Brussels.
- Scholander, P.F., Hammel, H.T., Bradstreet, E.D. and Hemmingsen, E.A. (1965)** Sap pressure in vascular plants; Negative pressure can be measured in plants. *Science* **148**:339-346.
- Schönherr, J. and Riederer, M. (1986)** Plant cuticles sorb lipophilic compounds during enzymatic isolation. *Plant, Cell and Environment* **9**:459-466.
- Schulze, E.-D., Oren, R. and Lange, O.L. (1989)** Nutrient relations of trees in healthy and declining Norway spruce stands. In: *Forest Decline and Air Pollution. A Study of Spruce (Picea abies) on Acid Soils*. pp.392-417. (Eds.) E.-D. Schulze, O.L. Lange and R.Oren. Springer-Verlag, Berlin.
- Schweingruber, F.H., Braker, O.U. and Schar, E. (1979)** Dendro-climatic studies on conifers from central Europe and Great Britain. *Boreas* **8**:427-452.
- Shuttleworth, W.J. (1989)** Micrometeorology of temperate and tropical forest. *Philosophical Transactions of the Royal Society*. **B324**:299-334.
- Slatyer, R.O. (1967)** *Plant-water Relationships*. Academic Press, London.

- Solomon, A.M. (1986)** Transient response of forests to CO<sub>2</sub>-induced climate change: simulation modelling experiments in eastern North America. *Oecologia* **68**:567-579.
- Steven, H.M. and Carlisle, A. (1959)** *The Native Pinewoods of Scotland*. Oliver and Boyd, Edinburgh.
- Street, H.E. and Öpik, H. (1984)** *The Physiology of Flowering Plants: Their Growth and Development*. Arnold, London.
- Sucoff, E. (1971)** Timing and rate of bud formation in *Pinus resinosa*. *Canadian Journal of Botany* **49**(2):1821-1832.
- Sutcliffe, J. (1977)** *Plants and Temperature*. Studies in Biology no. 86. Arnold, London.
- Sutcliffe, J. (1979)** *Plants and Water*. Studies in Biology no. 14. 2nd Ed. Arnold, London.
- Tansley, A.G. (1965)** *The British Islands and Their Vegetation*. Fourth Impression. Cambridge University Press, Cambridge.
- Thompson, F.B. and Leyton, L. (1971)** Method for measuring the leaf surface area of complex shoots. *Nature* **229**:572.
- Tranquillini, W. (1964)** The physiology of plants at high altitudes. *Annual Review of Plant Physiology* **15**:345-362.
- Tranquillini, W. (1979)** *Physiological Ecology of the Alpine Timberline*. Springer-Verlag, Berlin.
- Troeng, E. and Linder, S. (1981a)** Gas exchange in a 20-year-old stand of Scots pine: I. Net photosynthesis of current and one-year-old shoots within and between seasons. *Physiologia Plantarum* **54**:7-14.

- Troeng, E. and Linder, S. (1981b)** Gas exchange in a 20-year-old stand of Scots pine: II. Variation in net photosynthesis and transpiration within and between trees. *Physiologia Plantarum* **54**:15-23.
- Turner, H., Häslar, R. and Schönenberger, W. (1982)** *Contrasting microenvironments and their effects on carbon uptake and allocation by young conifers near alpine treeline in Switzerland*. Proceedings from IUFRO Workshop, Ecology of Subalpine Zones, 1982, pp.22-30. (Ed.) R.H. Waring. Oregon.
- Tyree, M.T. and Karamanos, A.J. (1981)** Water stress as an ecological factor. In: *Plants and their Atmospheric Environment* pp.237-262. (Eds.) J. Grace, E.D. Ford and P.G. Jarvis. Blackwell Scientific Publications, Oxford.
- Unsworth, M.H. and Crossley, A. (1987)** The capture of wind-driven cloud by vegetation. In: *Pollutant Transport and Fate in Ecosystems*.pp.125-137. (eds.) P. Coughtrey, M. Martin and M.H. Unsworth. Blackwell Scientific Publications, Oxford.
- Ursino, D.J., Nelson, C.D. and Krotkov, G. (1968)** Seasonal changes in the distribution of photo-assimilated  $^{14}\text{C}$  in young pine plants. *Plant Physiology* **43**:845-852.
- van den Driessche, R. (1974)** Prediction of mineral nutrient status of trees by foliar analysis. *Botanical Review* **40**(3):347-394
- van Gardingen, P.R., Grace, J. and Jeffree, C.E. (1991)** Abrasive damage by wind to the needle surfaces of *Picea sitchensis* (Bong.) Carr. and *Pinus sylvestris* L.. *Plant, Cell and Environment* **14**:185-193.
- Waldman, J.M., Munger, J.W., Jacob, D.J., Flagan, R.C., Morgan, J.J. and Hoffmann, M.R. (1982)** Chemical composition of acid fog. *Science* **218**:677-680.
- Wardle, P. (1968)** Engelmann spruce (*Picea engelmannii* Engel.) at its upper limits on the Front Range, Colorado. *Ecology* **49**:483-495.

- Wardle, P. (1971)** An explanation for alpine timberline. *New Zealand Journal of Botany* **9**:371-402.
- Waring, R.H. and Running, S.W. (1976)** Water uptake, storage and transpiration by conifers: a physiological model. In: *Water and Plant Life: Problems and Modern Approaches*. pp.189-202. (Eds.) O.L. Lange, L. Kappen and E.-D. Schulze. Springer-Verlag, Berlin.
- Watt, A.S. and Jones, E.W. (1948)** The ecology of the Cairngorms. I. The environment and altitudinal zonation of the vegetation. *Journal of Ecology* **36**:283-304.
- White, J., Yeats, A. and Skipworth, G. (1979)** *Tables for Statisticians*. Stanley Thornes Ltd., Cheltenham.
- Wilson, C., Grace, J., Allen, S. and Slack, F. (1987)** Temperature and stature: a study of temperatures in montane vegetation. *Functional Ecology* **1**:405-413.

## APPENDIX I

Forestry Commission compost fertiliser for forest tree seedlings;

For every 100 l peat;

167 g	Enmag
27 g	Frittered trace elements 253 A
33 g	ground limestone

## APPENDIX II

Fortran 77 program used to calculate degree days;

```
PROGRAM DEGREE
REAL TEMP, DELTA
INTEGER I, JDAY
SUM = 0
DO 10 I= 1, 145
READ(7, *) JDAY, TEMP
DELTA = TEMP-5.0
IF (DELTA.LT. 0.0) THEN
DELTA = 0.0
ENDIF
SUM = SUM + DELTA
WRITE (8, *) JDAY, SUM
WRITE (6, *) JDAY, SUM
10 CONTINUE
STOP
END
```

### APPENDIX III

Composition of the leaf cutin acids of *Pinus sylvestris* and their relative abundance (most abundant set at 100), from Hunneman and Eglinton (1972).

Cutin acid	Relative abundance
12-OH C <sub>12</sub>	19
C <sub>16</sub>	22
14-OH C <sub>14</sub>	9
16-OH C <sub>16</sub>	22
7-OH C <sub>15</sub> diacid	3
8-OH C <sub>16</sub> diacid	3
9,16-diOH C <sub>16</sub>	100
9-OH C <sub>18</sub> diacid	1
9,18-diOH C <sub>18</sub>	2
9,10,18-triOH C <sub>18</sub> (erythro)	14
9,10,18-triOH C <sub>18</sub> (threo)	9

## APPENDIX IV

Foliar nutrient concentrations. Data from the Data set for the European Pine Model compiled by H. Schäfer and H. Krieger (1991).

Nutrient	g kg <sup>-1</sup>	Source
<b>N</b>	14.5 - 18.2	Faensen-Thiebes & Cornelius (1989)
	9.0 - 13.0	Helmisaari (1990)
	7.9 - 11.4	Troeng & Linder (1982)
	14.7 - 18.5	Seibt & Wittich (1965)
	11.0 - 18.9	Gussone (1974)
	16.6 - 21.4	Kuppers <i>et al.</i> (1985)
	14.3 - 17.5	Rehfuess (1990)
	7.7 - 14.3	Raitio (1990)
	12.5 - 22.5	Heinsdorf <i>et al.</i> (1986)
	12.0 - 15.0	Wolf 1989
<b>P</b>	1.4 - 1.5	Faensen-Thiebes & Cornelius (1989)
	0.8 - 1.5	Helmisaari (1990)
	1.5 - 1.8	Seibt & Wittich (1965)
	1.3 - 2.3	Gussone (1974)
	1.5 - 1.6	Kuppers <i>et al.</i> (1985)
	1.4 - 1.7	Rehfuess (1990)
	1.3 - 1.6	Raitio (1990)
	1.3 - 1.9	Heinsdorf <i>et al.</i> (1986)
	1.1 - 1.5	Wolf (1989)
<b>K</b>	5.4 - 6.4	Faensen-Thiebes & Cornelius (1989)
	2.3 - 4.5	Helmisaari (1990)
	6.2 - 7.8	Seibt & Wittich (1965)
	6.3 - 8.8	Gussone (1974)
	4.3 - 4.5	Kuppers <i>et al.</i> (1985)
	5.1 - 6.1	Rehfuess (1990)
	3.8 - 7.7	Raitio (1990)
	4.4 - 5.6	Heinsdorf <i>et al.</i> (1986)
	3.0 - 4.6	Wolf (1989)
<b>Ca</b>	2.6 - 4.8	Faensen-Thiebes & Cornelius (1989)
	1.8 - 3.6	Helmisaari (1990)
	1.6 - 2.6	Seibt & Wittich (1965)
	1.4 - 3.9	Gussone (1974)
	2.2 - 3.4	Kuppers <i>et al.</i> (1985)
	2.1 - 3.3	Rehfuess (1990)
	0.3 - 2.4	Raitio (1990)
	1.9 - 4.2	Heinsdorf <i>et al.</i> (1986)
	1.6 - 3.4	Wolf (1989)

**Appendix IV (contd.)**

<b>Mg</b>	0.9	-	1.0	Faensen-Thiebes & Cornelius (1989)
	0.4	-	1.1	Helmisaari (1990)
	0.8	-	1.0	Seibt & Wittich (1965)
	0.7	-	2.3	Gussone (1974)
	0.2	-	0.9	Kuppers <i>et al.</i> (1985)
	0.7	-	0.9	Rehfuess (1990)
	3.8	-	7.7	Raitio (1990)
	4.4	-	5.6	Heinsdorf <i>et al.</i> (1986)
	3.0	-	4.6	Wolf (1989)

## APPENDIX V

Worked example of the combined curve analysis of variance used in chapter 5 to test for the reduction in residual variance of two separate curves compared to their combined curve (from the ANOVA scheme of Ross, 1981).

For June n-1 shoots from the valley (V) and above the tree-line (T).

### Data from curve-fitting print-out;

residual sum of squares for the separate curves	$V_{n-1} = 472.064$ $T_{n-1} = 172.364$
combined curve residual sum of squares	$V_{n-1} \text{ \& } T_{n-1} = 958.588$

### Method

1. Add residual sum of squares for the separate curves and call this A (sum of squares from fitted curves (error)).

$$A = 644.428$$

2. Subtract A from residual sum of squares of combined curve and call this B (sum of squares for difference between curves).

$$B = 314.160$$

3. Calculate mean squares for the separate curves by dividing B by its degrees of freedom;

$$\begin{aligned} \text{where d.f.} &= (\text{no. of curves} - 1) \text{ no. of unknown parameters} \\ &= (2 - 1) 3 \end{aligned}$$

$$\begin{aligned} B / \text{d.f.} &= 314.160 / 3 \\ &= 104.720 \end{aligned}$$

4. Calculate mean squares for combined curves by dividing A by its degrees of freedom;

$$\begin{aligned}\text{where d.f.} &= \text{no. observations} - (\text{no. of curves} \times \text{no. unknown} \\ &\hspace{15em} \text{parameters}) \\ &= 71 - (1 \times 3)\end{aligned}$$

$$\begin{aligned}A / \text{d.f.} &= 644.428 / 68 \\ &= 9.477\end{aligned}$$

5. Carry out a variance ratio test ( $F$  test) on  $(B / \text{d.f.}) / (A / \text{d.f.})$ .

$$\begin{aligned}\text{for } 104.720 / 9.477 \\ F_{\text{calc}} &= 11.050 \\ F_{\text{table}} &= 6.12\end{aligned}$$

### **Result**

The separate curves differ significantly from the combined curves at the 0.1 % level ( $P=0.001$ ).