

**Generation and analysis of ES cells expressing individual isoforms of AML1/Runx1 gene in a constitutive and regulatable manner**

Anna Liakhovitskaia

Thesis presented for the degree of Doctor of Philosophy

University of Edinburgh

2005



## **Acknowledgements**

I would like to thank my supervisor Dr Alexander Medvinsky for giving me the opportunity to do the research and for his guidance along the way. I also want to thank all past and present members of our laboratory especially Dr Igor Samokhvalov.

In addition, specific thanks must go to

Professor Hermann Bujard, Dr Ian Chambers, Dr Andrew Smith, Dr Michael Kyba, Dr George Daley, Dr Issay Kitabayashi and Dawn Fisher for providing plasmids, cells and advice,

Dr Dimitris Kioussis, Dr Nicky Haster and Mauro Tolaini for fruitful collaboration,

Jan Ure for blastocyst injections and help with tissue culture,

Jan Vrana for help with FACS analysis,

Carol Manson and animal unit staff for looking after my mice,

tissue culture staff for their help.

Finally, I would like to thank the Darwin Trust of Edinburgh for providing me with a PhD studentship.

## ABSTRACT

AML1 long splice isoform regulates transcription of many hematopoietic specific genes and may act as both transcriptional activator and repressor. The AML1 short isoform which lacks the transactivation domain can bind DNA but is not capable of activating transcription; suggesting that it acts in a dominant-negative manner. Thus, if the long AML1 isoform induces differentiation of hematopoietic progenitors, the short isoform may promote their self-renewal. This hypothesis may be tested using an engineered ES cell differentiation system overexpressing individual AML1 isoforms. Therefore, we aimed here to generate ES cell lines overexpressing individual AML1 isoforms constitutively or in a regulatable fashion in order to test their biological functions. Both, long and short AML1 isoforms demonstrated cytotoxic effect when overexpressed constitutively in ES cells. In order to overcome the toxicity problem, these isoforms have been expressed conditionally in an inducible fashion using the tetracycline gene expression system. Different experimental designs were tried to conditionally overexpress the isoforms in ES cells. Finally, the AML1 isoforms were targeted into the HPRT homing site of Ainv15 ES cells which harbour both regulatory and responsive elements of the tetracycline gene expression system. Since AML1 isoforms were linked to a fluorescent EGFP reporter the expression of AML1 could be readily monitored following induction with doxycycline. Upon doxycycline induction reduction in size and number of undifferentiated colonies was observed that has not been associated with obvious apoptotic events. AML1 induction has also been initiated during the putative haemangioblast differentiation stage. However, no obvious deviation in clonogenic haematopoietic activity has been observed in induced and non-induced differentiating embryoid bodies.

# TABLE OF CONTENTS

<u>TABLE OF CONTENTS.....</u>	<u>1</u>
<u>TABLE OF FIGURES.....</u>	<u>6</u>
<u>ABBREVIATIONS.....</u>	<u>8</u>
<u>CHAPTER 1: INTRODUCTION.....</u>	<u>10</u>
1.1. GENERAL INTRODUCTION.....	10
1.2. AML1 STRUCTURE AND EXPRESSION.....	12
1.2.1. THE AML1 GENE STRUCTURE.....	12
1.2.2. REGULATION OF THE AML1 TRANSCRIPTION AND TRANSLATION.....	12
1.2.3. AML1 EXPRESSION PATTERN.....	14
1.2.4. SUBCELLULAR LOCALIZATION OF THE AML1 PROTEIN.....	15
1.3. AML1 FUNCTION: AML1 AS A TRANSCRIPTIONAL REGULATOR.....	17
1.4. THE ROLE OF AML1 IN A MOUSE EMBRYONIC DEVELOPMENT.....	22
1.4.1. HEMATOPOIETIC DIFFERENTIATION <i>IN VIVO</i> .....	22
1.4.2. AML1 IS A REGULATOR OF THE DEFINITIVE HEMATOPOIESIS DURING MOUSE EMBRYOGENESIS.....	24
1.4.3. THE ROLE OF AML1 IN THE VASCULAR NETWORK DEVELOPMENT.....	27
1.4.4. HEMATOPOIETIC DIFFERENTIATION <i>IN VITRO</i> : ES CELL MODEL.....	29
1.5. THE ROLE OF AML1 IN ADULT HEMATOPOIESIS.....	32
1.5.1. INTRODUCTION.....	32
1.5.2. THE ROLE OF AML1 IN THE HSCs FUNCTIONING.....	32
1.5.3. THE ROLE OF AML1 IN THE MEGAKARYOCYTIC DEVELOPMENT.....	33
1.5.4. THE ROLE OF AML1 IN THE ERYTHROCYTES DEVELOPMENT.....	34
1.5.5. THE ROLE OF AML1 IN THE GRANULOCYTES AND MONOCYTES DEVELOPMENT.....	34
1.5.6. THE ROLE OF AML1 IN LYMPHOCYTE DEVELOPMENT.....	35
1.5.6.1. The role of AML1 in the B-cells development.....	35
1.5.6.2. The role of AML1 in the T-cells development.....	36
1.6. FUNCTIONAL ROLE OF INDIVIDUAL ISOFORMS OF AML1.....	39

CHAPTER 2: INTRODUCTION .....	
EXPERIMENTAL SYSTEMS FOR GENE EXPRESSION IN ES CELLS .....	42
2.1. CONSTITUTIVE GENE EXPRESSION .....	42
2.2. CONDITIONAL GENE EXPRESSION .....	42
2.2.1. CONDITIONAL GENE ACTIVATION USING CRE RECOMBINASE .....	42
2.2.2. CONDITIONAL GENE ACTIVATION USING CHEMICAL INDUCTION.....	43
2.2.2.1. RU486 (mifepristone) gene expression system .....	44
2.2.2.2. Ecdysone gene expression system .....	46
2.2.2.3. Tetracycline gene expression system.....	47
CHAPTER 3: MATERIALS AND METHODS .....	51
3.1. MOLECULAR BIOLOGY METHODS .....	51
3.1.1. LIST OF MAIN SOLUTIONS .....	51
3.1.2. CLONING.....	51
3.1.2.1. General remarks.....	51
3.1.2.2. Restriction.....	52
3.1.2.3. 5' overhang nucleotides filling and 3' overhang nucleotides removal.....	52
3.1.2.4. Isolation of DNA fragments from agarose.....	52
3.1.2.5. Ligation.....	52
3.1.2.6. Transformation of E. coli bacterial cells.....	53
3.1.2.7. Screening of recombinant clones.....	53
3.1.2.7.1. Colony lifts.....	53
3.1.2.7.2. Hybridisation of the membrane with a radioactive probe.....	53
3.1.2.7.3. Radiolabelling of DNA.....	54
3.1.2.8. Isolation of plasmid DNA.....	54
3.1.2.9. Site-directed mutagenesis .....	54
3.1.2.10. TA cloning of PCR products.....	54
3.1.3. DNA SEQUENCING.....	55
3.1.4. PCR (POLYMERASE CHAIN REACTION).....	55
3.1.5. ISOLATION OF DNA FRAGMENTS FOR PRONUCLEAR MICROINJECTIONS .....	56
3.1.6. SOUTHERN BLOT HYBRIDISATION.....	56
3.1.6.1. Isolation of genomic DNA from ES cells and animal tissues.....	56
3.1.6.2. Restriction digestion of genomic DNA.....	57
3.1.6.3. Electrophoresis.....	57

3.1.6.4. Blotting .....	57
3.1.6.5. Hybridization .....	57
3.1.6.6. Labelling reaction .....	58
3.1.6.7. Probe stripping.....	58
3.1.7. ISOLATION AND REVERSE TRANSCRIPTION OF RNA .....	58
3.1.7.1. RNA isolation .....	58
3.1.7.2. Reverse transcription – polymerase chain reaction (RT-PCR).....	59
3.1.8. LUCIFERASE REPORTER ASSAY .....	59
3.2. CELL BIOLOGY METHODS .....	60
3.2.1. THAWING ES CELLS .....	60
3.2.2. PASSAGING AND EXPANSION OF ES CELLS .....	60
3.2.3. FREEZING OF ES CELLS .....	61
3.2.4. TRANSFECTION OF ES CELLS.....	61
3.2.4.1. Electroporation.....	61
3.2.4.2. Lipofection.....	62
3.2.4.2.1. Lipofection of the E14/T cells with episomal vectors .....	62
3.2.4.2.2. Lipofection of the regulatory and B8 ES cells with AML1/luciferase responsive constructs .....	62
3.2.5. SELF-RENEWAL ASSAY.....	62
3.2.6. DIFFERENTIATION OF ES CELLS .....	62
3.2.6.1. EB differentiation assay.....	62
3.2.6.2. Methylcellulose differentiation assay .....	63
3.2.7. FLOW CYTOMETRY.....	63
3.2.7.1. Preparation of cells for flow cytometry .....	63
3.2.7.2. Co-staining using annexin V-PE and 7-AAD.....	64
3.3. ANIMALS.....	64

CHAPTER 4: RESULTS.....

CONSTITUTIVE EXPRESSION OF INDIVIDUAL ISOFORMS OF AML1 IN ES CELLS ..... 65

4.1. INTRODUCTION.....	65
4.2. GENERATION OF EPISOMAL VECTORS .....	65
4.3. SUPERTRANSFECTION OF ES CELLS.....	67

CHAPTER 5: RESULTS..... 70

GENERATION OF AML1/RTTA REGULATORY ES CELLS AND MICE..... 70

5.1. INTRODUCTION..... 70

5.2. GENERATION OF THE REGULATORY CONSTRUCT ..... 70

5.3. TARGETING OF THE AML1 GENE LOCUS ..... 78

5.4. CRE-MEDIATED EXCISION OF THE SELECTION CASSETTE ..... 81

5.5. GENERATION OF AML1/RTTA REGULATORY MICE..... 83

5.6. ANALYSIS OF THE RTTA TRANSGENE EXPRESSION IN *IN VITRO* DIFFERENTIATION ASSAY ..... 83

CHAPTER 6: RESULTS..... 88

GENERATION OF RESPONSIVE ES CELLS AND MICE..... 88

6.1. INTRODUCTION..... 88

6.2. GENERATION OF RESPONSIVE ES CELL LINES ..... 88

6.2.1. GENERATION OF THE LUCIFERASE RESPONSIVE CONSTRUCTS..... 88

6.2.2. TRANSFECTION OF AML1/RTTA REGULATORY ES CELLS WITH LUCIFERASE RESPONSIVE CONSTRUCTS ..... 90

6.2.3. TRANSFECTION OF B8 ES CELLS WITH RESPONSIVE CONSTRUCTS..... 94

6.3. GENERATION OF RESPONSIVE MOUSE STRAINS ..... 96

6.3.1. GENERATION OF THE EYFP RESPONSIVE CONSTRUCTS ..... 96

6.3.2. GENERATION OF THE AML1/EYFP RESPONSIVE MICE..... 99

6.3.3. DOXYCYCLINE INDUCIBLE EYFP EXPRESSION IN RESPONSIVE MICE ..... 105

CHAPTER 7: RESULTS..... 109

INDUCIBLE EXPRESSION OF THE AML1 ISOFORMS: TET-ON/HPRT GENE EXPRESSION SYSTEM..... 109

7.1. INTRODUCTION..... 109

7.2. GENERATION OF THE GENE TARGETING CONSTRUCTS ..... 111

7.3. TARGETING OF THE AINV15 CELLS..... 116

7.4. SELF-RENEWAL ABILITIES OF AINV15 CELLS AND ITS DERIVATIVES..... 116

7.5. AML1 OVEREXPRESSION DOES NOT INDUCE APOPTOSIS IN ES CELLS ..... 121

7.6. INFLUENCE OF THE AML1 OVEREXPRESSION ON THE ES CELLS HEMATOPOIETIC  
DIFFERENTIATION *IN VITRO* ..... 122

CHAPTER 8: DISCUSSION..... 131

REFERENCES ..... 139

APPENDIX..... 160

## TABLE OF FIGURES

Figure 1. Exon-intron structure of the AML1 gene locus and several alternatively splice isoforms .....	13
Figure 2. Transcriptional complex formation by AML1 .....	21
Figure 3. Schematic representation of the multilineage differentiation of hematopoietic stem cells in bone marrow.....	23
Figure 4. Schematic representation of the HSCs distribution in hematopoietic tissues of a mouse embryo.....	25
Figure 5. Schematic representation of RU486 and ecdysone gene inducible systems .....	45
Figure 6. Schematic representation of natural and artificial tetracycline responsive systems.....	48
Figure 7. Diagram of episomal vectors.....	66
Figure 8. EGFP expression in the E14/T supertransfected cells.....	68
Figure 9. The AML1 overexpression has an inhibitory influence on the ES cell growth .....	69
Figure 10. Schematic representation of the Tet-On gene expression system for conditional overexpression of the AML1 individual isoforms in hematopoietic progenitors .....	71
Figure 11. Diagram of the three step cloning of the rtTA gene expression cassette .	72
Figure 12. Diagram of the AML1 genomic clones.....	75
Figure 13. Schematic representation of the rtTA gene expression cassette cloning into the AML1 genomic DNA containing plasmid.....	76
Figure 14. Diagram of the four step cloning of the regulatory construct .....	77
Figure 15. Targeting of the AML1 gene locus .....	80
Figure 16. Cre-mediated recombination in the AML1 gene locus .....	82
Figure 17. Genotyping of the AML1/rtTA regulatory mice.....	85
Figure 18. Kinetics of rtTA and AML1 expression during ES cells <i>in vitro</i> differentiation.....	87
Figure 19. Diagram of the two step cloning of the luciferase responsive constructs for transient transfection assays.....	89
Figure 20. Doxycycline failed to induce the luciferase reporter gene expression in transiently transfected undifferentiated AML1/rtTA regulatory ES cells .....	92
Figure 21. Doxycycline failed to induce the luciferase reporter gene activation in the transiently transfected differentiated AML1/rtTA regulatory ES cells .....	93
Figure 22. Doxycycline induced the 40 fold luciferase reporter gene activation in the transiently transfected B8 cells .....	95
Figure 23. Diagram of the four step cloning of the AML1/EYFP responsive construct .....	97
Figure 24. Possible arrangements of AML1A/EYFP integrants in the genome.....	101
Figure 25. Southern blot hybridisation of genomic DNA isolated from the AML1A/EYFP transgenic mice biopsies.....	102
Figure 26. Possible arrangements of the AML1B/EYFP integrants in genome.....	103
Figure 27. Southern blot hybridisation of genomic DNA isolated from the AML1B/EYFP transgenic mice biopsies.....	104
Figure 28. Doxycycline induces EYFP expression in thymocytes of double transgenic mice .....	108

Figure 29. Tet-On/HPRT gene expression system .....	110
Figure 30. Sequence of the pLox plasmid .....	112
Figure 31. Modification of the pLox plasmid.....	114
Figure 32. Diagram of the two steps cloning of the constructs for site-specific recombination. ....	115
Figure 33. Flow cytometric analysis of EGFP expression in Ainv15-AML1A cells .....	117
Figure 34. Flow cytometric analysis of EGFP expression in Ainv15-AML1B cells .....	118
Figure 35. Self-renewal abilities of the Ainv15-AML1A (and B) and Ainv15 cells cultivated at different concentrations of doxycycline.....	120
Figure 36. AML1A overexpression does not induce apoptosis in undifferentiated Ainv15 cells .....	124
Figure 37. AML1B overexpression does not induce apoptosis in undifferentiated Ainv15 cells .....	126
Figure 38. Annexin V and 7-AAD co-staining of Ainv15 cells .....	127
Figure 39. Scheme of the Ainv15 cell hematopoietic differentiation <i>in vitro</i> assay	128
Figure 40. Overexpression of $_{AML1}$ isoforms does not significantly influence ES cell hematopoietic differentiation <i>in vitro</i> . ....	129

## ABBREVIATIONS

7-AAD	7-amino-actinomycin D
AGM	aorta/gonads/mesonephros
AML	acute myeloid leukaemia
BGH	bovine growth hormone
BMP	bone morphogenetic protein
bp	base pairs
bTRP	bidirectional tetracycline responsive promoter
CAT	chloramphenicol acetyl transferase
CBF	core binding factor
CMV	cytomegalovirus
DB	DNA binding
DN	double negative
DP	double positive
E	day of the embryonic development
EB	embryoid body
EC	embryonic carcinoma
ECMV	encephalomyocarditis virus
EcR	ecdysone receptor
EcRE	ecdysone responsive element
EGFP	enhanced green fluorescent protein
EYFP	enhanced yellow fluorescent protein
ES	embryonic stem
FACS	fluorescence activated cell sorting
G-CSF	granulocyte colony-stimulating factor
IE	immediate early
IL	interleukin
IRES	internal ribosomal entry site
kb	kilobase pairs
LB	ligand binding
LIF	leukaemia inhibitory factor
LMT	low melting temperature
HAT	histone acetyltransferase
HSC	hematopoietic stem cell
HDAC	histone deacetylases
HPRT	hypoxanthine phosphoribosyltransferase

HSV herpes simplex virus  
M-CSF macrophage colony-stimulating factor  
MHC major histocompatibility complex  
MoMLV Moloney murine leukaemia virus  
MCS multiple cloning site  
Neo<sup>r</sup> neomycin resistance  
NLS nuclear localization signal  
NMTS nuclear matrix targeting signal  
ORF open reading frame  
pA polyadenylation  
PCR polymerase chain reaction  
PE phycoerythrin  
PEBP polyomavirus enhancer binding protein  
PGK phosphoglycerate kinase  
PRE progesterone responsive element  
Puro<sup>r</sup> puromycin resistance  
RT-PCR reverse transcription – polymerase chain reaction  
RXR retinoid X receptor  
rtTA reverse tetracycline transactivator  
SCF stem cell factor  
SP single positive  
SPA synthetic polyadenylation signal  
SV simian virus  
TA transactivation, transcriptional activation  
TCR T-cell receptor  
TGF transforming growth factor  
Th T-helper  
TK thymidine kinase  
TRP tetracycline responsive promoter  
tTA tetracycline transactivator  
UAS upstream activation sequence  
UTR untranslated region

## Chapter 1: INTRODUCTION

### 1.1. General introduction

The AML1/Runx1/CBF $\alpha$ 2/PEBP2 $\alpha$  gene was described in the t(8; 21) chromosomal translocation in a patient with acute myeloid leukaemia (AML) (Miyoshi et al. 1991). Simultaneously, the mouse AML1 protein was purified by two research groups independently. It was found to be capable of binding to (i) the polyomavirus enhancer (therefore, the protein was called PEBP2 (polyomavirus enhancer binding protein)) (Kamachi et al. 1990) and (ii) the core site of the Moloney murine leukaemia virus (MoMLV) enhancer (the protein was called CBF (core binding factor)) (Wang and Speck 1992). The PEBP2/CBF protein was initially reported to be consisted of two subunits, designated as  $\alpha$  and  $\beta$  (Wang and Speck 1992). The PEBP2 $\alpha$ /CBF $\alpha$  subunit binds DNA, whereas PEBP2 $\beta$ /CBF $\beta$  does not bind DNA but significantly enhances DNA binding ability of the  $\alpha$  subunit (Ogawa et al. 1993; Wang et al. 1993). The mouse PEBP2 $\alpha$ /CBF $\alpha$  subunit is highly homologous to human AML1. It contains 128 amino acid *Runt* domain homologous to *Drosophila runt* genes (Ogawa et al. 1993; Wang et al. 1993). It has been shown that the *Runt* domain is responsible for both DNA binding and heteromerisation abilities of the AML1 protein. Later, two novel *Runt* homology domain containing genes, AML2/Runx3 and AML3/Runx2, were also described (Levanon et al. 1994; Wijmenga et al. 1995). They both bind DNA and heterodimerisation with the CBF $\beta$  protein enhances their DNA-binding ability. According to modern nomenclature, AML1, AML2 and AML3 constitute the Runx gene family (Westendorf and Hiebert 1999).

The involvement of AML1 in leukaemogenesis has been extensively studied (reviewed by Perry et al. 2002; Asou 2003). A few types of chromosomal translocations that involve AML1 are associated with different types of leukaemia. The t(8; 21) translocation has been found in 10-15% of all AML cases (Bitter et al. 1987). The t(3; 21) translocation is associated with chronic myeloid leukaemia (Mitani et al. 1994). The t(12; 21) translocation is common in the childhood B-cell leukaemia (Golub et al. 1995). The t(16; 21) translocation is associated with therapy-related myeloid leukaemia (Gamou et al. 1998). Of note, The CBF $\beta$  gene involvement in chromosomal aberrations associated with acute myeloid leukaemia has also been shown (Liu et al. 1993).

It has also been shown that AML1 plays an important role in normal haematopoiesis. It has been shown to be a transcription factor (Zaiman et al. 1995). A number of haematopoiesis related genes are targets of AML1 (Hernandez-Munain and Krangel 1994; Nuchprayoon et al. 1994; Zhang et al. 1996). AML1 is an important regulator of haematopoietic development in embryogenesis (reviewed by Tracey and Speck 2000; Speck 2001). It is indispensable in embryonic generation of the definitive haematopoietic cells. This chapter reviews current knowledge of AML1 biology during embryonic development and in the adult organism.

## **1.2. AML1 structure and expression**

### **1.2.1. The AML1 gene structure**

The AML1 gene is located on chromosome 21 in the human genome (Miyoshi et al. 1991; Levanon et al. 1994) and on homologous chromosome 16 in the mouse genome (Bae et al. 1994). It has a complex structure (see Figure 1). The human AML1 gene spans 260 kb (kilobase pairs) and contains 12 exons (Levanon et al. 2001). Only partial data about the mouse AML1 gene structure is available, but it appears to be similar to the human one (Bae et al. 1994; Telfer and Rothenberg 2001). 12 different alternatively spliced variants of the human cDNA (Levanon et al. 2001) and 9 variants of the mouse cDNA (Levanon et al. 1996; Telfer and Rothenberg 2001) have been described (see Figure 1). These alternatively spliced variants of the AML1 cDNA encode a large repertoire of proteins ranging in size from 20 to 52 kilodaltons (Miyoshi et al. 1991; Bae et al. 1993; Bae et al. 1994; Zhang et al. 1997; Tsuji and Noda 2000; Fujita et al. 2001; Levanon et al. 2001; Telfer and Rothenberg 2001). Functional roles of individual isoforms of AML1 will be discussed below.

AML1 protein contains two major domains: the *Runt* domain and the transactivation (TA) domain. The *Runt* domain consists of 128 amino acids and is located in the N-terminal part of the molecule. Two functions of the *Runt* domain have been described: (i) DNA binding and (ii) heterodimerisation with the CBF $\beta$  protein (Ogawa et al. 1993). Crystal structure analysis of the *Runt* domain showed that it consists mostly of antiparallel  $\beta$ -sheets forming a  $\beta$ -barrel with an S-type immunoglobulin fold (Berardi et al. 1999; Nagata et al. 1999). Interestingly, several other transcription factors (p53, NF- $\kappa$ B etc.) have the same fold (reviewed by Bork et al. 1994; Rudolph and Gergen 2001). The TA domain is located at the C-terminus of the protein and presumably interacts with other transcriptional factors (Ogawa et al. 1993; Bae et al. 1994; Miyoshi et al. 1995).

### **1.2.2. Regulation of the AML1 transcription and translation**

Two different promoters (distal and proximal) drive transcription of AML1 (Ghozi et al. 1996). The distance between the promoters is about 160 kb in human genome. The length of the longest primary transcripts is 260 kb (distal transcripts) and 100 kb (proximal transcripts) (Levanon et al. 2001). Several polyadenylation signals are interspersed in the gene locus. The alternative polyadenylation signals

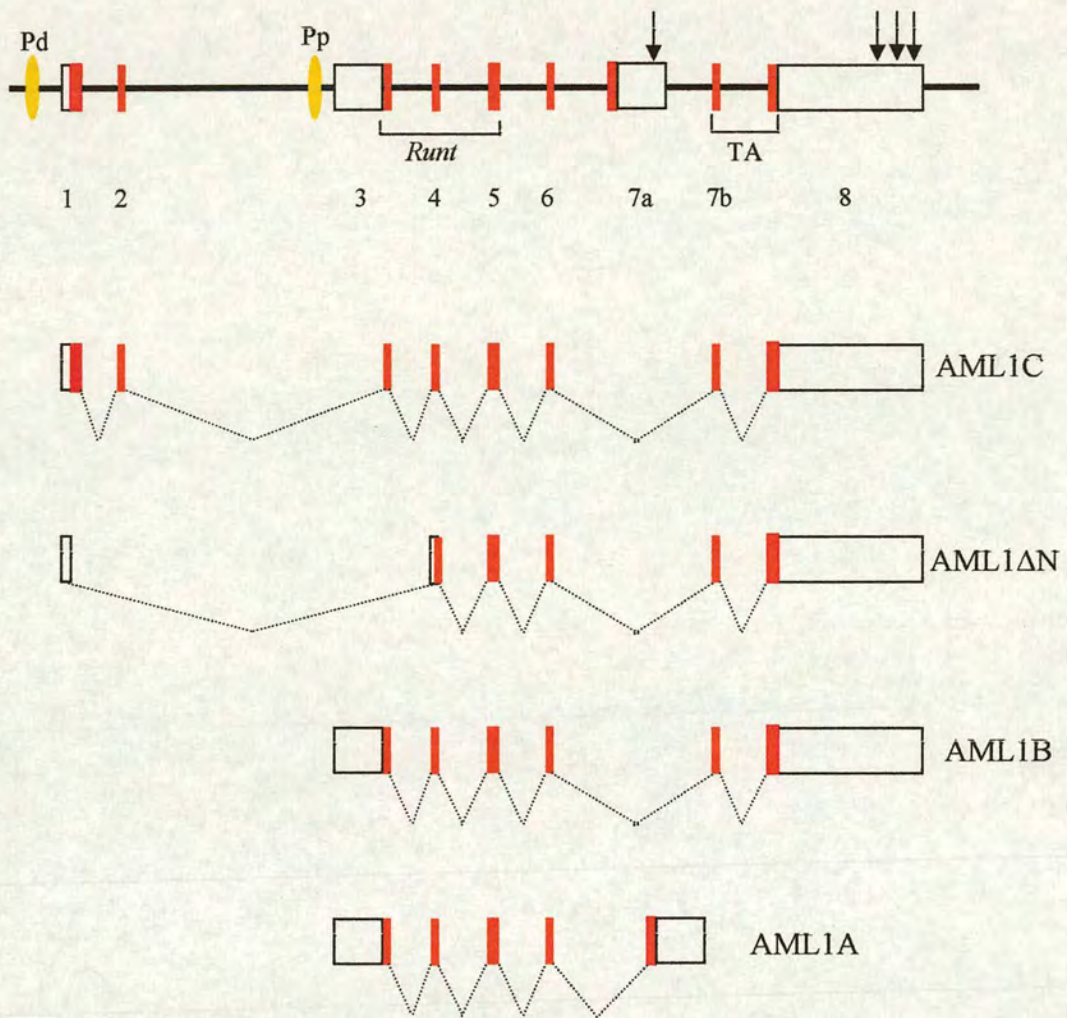

**Figure 1. Exon-intron structure of the AML1 gene locus and several alternatively splice isoforms**

The upper diagram shows the exon-intron structure of the AML1 gene locus. The distal (Pd) and proximal (Pp) promoters are designated by yellow ovals. Red boxes represent coding regions of exons, while white boxes show untranslated regions (UTRs). The exons numbers are shown below the diagram. Vertical arrows designate polyadenylation signals. The exons 3, 4 and 5 encode the *Runt* domain and the exons 7B and 8 encode the transactivation (TA) domain. The structure of the four most well studied AML1 isoforms is shown below the AML1 gene locus diagram. The 5' end part of the exon 4 is translating in all transcripts apart from AML1ΔN where the initiator ATG is located at the middle of the exon (see Chapters 1.2 and 1.6).

provide a mechanism for the generation of a set of transcripts of different lengths (Miyoshi et al. 1995). The regulation of activation and termination of the AML1 transcription as well as the spatiotemporal pattern of proximal and distal promoter activities is important for understanding various aspects of the AML1 biology. However, this issue remains poorly investigated. Only one attempt has been made to investigate the role of the promoter switch in cell fate decision (Telfer and Rothenberg 2001). To this end the activity of the AML1 promoters during lymphoid differentiation was studied. It was found that lymphoid progenitors, differentiated B- and T-cells preferentially use the AML1 distal promoter, whereas the switch onto the AML1 proximal promoter is strongly associated with the natural killer cell fate decision (Telfer and Rothenberg 2001).

The distal and proximal transcripts differ in structure and size of their 5' untranslated regions (UTR). 5' UTRs of the AML1 distal transcripts are rather short whereas 5' proximal UTRs are very long (more than 1.6 kb), GC-rich and may form the stable stem-loop structures (Levanon et al. 1996). 15 ATG codons upstream of the initiator ATG (uATGs) were found in the proximal 5' UTR. Many of the uATGs were followed by a short open reading frame (ORF). These short ORFs may have an inhibitory influence on the initiation of translation at the downstream initiator ATG (Kozak 1991). Interestingly, these features are characteristic for internal ribosomal entry sites (IRES) (reviewed by van der Velden and Thomas 1999). Indeed, IRES mediated initiation of the proximal transcripts translation was confirmed experimentally (Pozner et al. 2000). At the same time, the translation of distal transcripts is initiated via the usual cap-dependent mechanism. It is conceivable that IRES-mediated translation may be an important tool in regulation of the AML1 activity, since it has been shown that IRES located within the proximal 5' UTR has different levels of activity in different cell lines (Pozner et al. 2000). The IRES activity is very low in nonhematopoietic cell lines, but is high in such cells as Jurkat T-cells and K562 erythro-megakaryocytic progenitor cells. Induction of megakaryocytic differentiation in K562 cells is associated with upregulation of IRES activity whereas erythroid differentiation of the cells causes downregulation of the IRES-mediated translation (Pozner et al. 2000).

### **1.2.3. AML1 expression pattern**

Expression of AML1 was studied by Northern analysis and different results have been obtained for mouse and human tissues. In adult mouse the AML1

expresses at highest level in the thymus and at lower level in the lung, the heart and the spleen (Satake et al. 1995). In human tissues the thymus and the spleen also show high level of AML1 expression. In addition, expression of AML1 has also been revealed in the lung, the liver, the skeletal muscles, the kidney, the pancreas, the genital glands, the peripheral blood but not in the heart (Miyoshi et al. 1995). Generation of the AML1 reporter mice provided a tool for more precise analysis of the AML1 expression pattern. A reporter mouse strain with the LacZ reporter targeted into the AML1 gene locus was used for the analysis of the AML1 expression during embryonic development (North et al. 1999). AML1 expression has been found in all major hematopoietic sites in an embryo (dorsal aorta, yolk sac, vitelline and umbilical arteries and foetal liver) as well as in some non-hematopoietic sites such as the olfactory epithelium, the spinal ganglia and the maxillary processes. The mouse line with the enhanced green fluorescent protein (EGFP) reporter targeted into the AML1 gene locus has been used for the analysis of the AML1 expression in the mouse adult haematopoietic system (Lorsbach et al. 2004; North et al. 2004). The immature hematopoietic progenitors and more mature cells of myeloid, B- and T-lymphoid lineages have high levels of AML1 expression. There is no/low expression of AML1 in erythroid cells. These reports confirm the earlier data obtained using immunocytochemistry and *in situ* hybridisation methods (Simeone et al. 1995; Corsetti and Calabi 1997).

#### **1.2.4. Subcellular localization of the AML1 protein**

Immunofluorescence labeling experiments demonstrated that AML1 is a nuclear protein. It contains the nuclear localization signal (NLS) which has been mapped within the *Runt* domain (Lu et al. 1995). Furthermore, the AML1 protein is associated with nuclear matrix. AML1 contains the nuclear matrix targeting signal (NMTS) which is physically distinct from NLS; NMTS resides within the TA domain (Zeng et al. 1997). AML1 and transcriptionally active DNA polymerase II are colocalized in a nucleus and linked to the nuclear matrix (Zeng et al. 1998). Furthermore, experiments with the fluorescent AML1-EGFP fusion protein have shown that the protein is colocalized with nascent transcripts (Harrington et al. 2002). These findings suggest that NMTS directs AML1 to the nuclear matrix associated with subnuclear transcriptionally active sites. Targeting of a transcriptional factor to a specific subnuclear domain may be essential for transcription regulation, since it may facilitate transcriptional complex assembling. Mislocalization of a transcriptional factor in the nucleus may perturb expression of

target genes (reviewed by Stein et al. 1998). For instance, AML1/ETO is a chimeric protein, which is generated as a result of translocation t(8; 21). The AML1/ETO chimeric protein contains the N-terminal part of AML1 and almost entire ETO protein (Kozu et al. 1993). Therefore, AML1/ETO lacks the AML1 NMTS. As a result AML1/ETO is directed to the sites which do not coincide with AML1 subnuclear localization (McNeil et al. 1999). This is one of the mechanisms, which presumably compromise gene expression in AML1/ETO transformed cells.

### 1.3. AML1 function: AML1 as a transcriptional regulator

AML1 is a site-specific DNA binding protein which recognizes the nucleotide sequence 5'-TGPyGGTPy-3' (Py: pyrimidine) (Kamachi et al. 1990; Melnikova et al. 1993). Transcriptional activity of AML1 has been demonstrated (Zaiman et al. 1995). Subsequent studies have shown that AML1 acts as a transcriptional organizer facilitating an assembly of an active transcriptional complex on the promoter of a target gene. Close and sometimes overlapping localization of transcription factors binding sites are usual for many promoters. By this mutual cooperation of transcriptional factors an assembly of a transcription factor complex is ensured and results in promoter activation. On its own AML1 is a weak transcription activator, but cooperation with other DNA binding transcription factors enhances its transcriptional activity. For example, (i) AML1 and c-Myb functional cooperation is necessary for the T cell receptor (TCR)  $\delta$  enhancer activation (Hernandez-Munain and Krangel 1994), (ii) AML1 functionally interacts with the PU.1 and C/EBP proteins in order to activate transcription from the macrophage colony-stimulating factor (M-CSF) receptor promoter (Zhang et al. 1994; Zhang et al. 1996; Petrovick et al. 1998), (iii) AML1 and ETS-1 functionally cooperate on the TCR $\alpha$ , TCR $\beta$  and MoMLV enhancer, B-cell specific  $\mu$  enhancer and I $\alpha$ 1 promoter (Wotton et al. 1994; Giese et al. 1995; Sun et al. 1995; Erman et al. 1998; Xie et al. 1999) and (iv) the LEF-1 (lymphocyte enhancer binding factor) protein enhances the DNA-binding abilities of AML1 and ETS on the TCR $\alpha$  enhancer (Giese et al. 1995; Mayall et al. 1997). The mechanism of the AML1 and ETS cooperation has been most extensively studied and will be discussed below.

AML1 interacts with DNA via its DNA binding *Runt* domain. However, subsequent studies have demonstrated that AML1 contains auto-inhibitory domains which form a complex with the *Runt* domain preventing DNA binding (Kanno et al. 1998; Gu et al. 2000). ETS-1 (E26 transformation specific) is a member of a large family of transcriptional regulators sharing the common DNA binding ETS domain (reviewed by Oikawa and Yamada 2003). As AML1, ETS-1 also contains auto-inhibitory domains interacting with the ETS DNA binding domain (Jonsen et al. 1996). Experiments have shown that AML1 and ETS interact via their auto-inhibitory domains and these protein-protein interaction activates their DNA binding abilities (Kim et al. 1999; Goetz et al. 2000). According to the model proposed, AML1 and ETS interact via their auto-inhibitory domains. As a result DNA binding domains release from negative regulatory complexes and may interact with DNA.

Several non-DNA binding proteins also enhance DNA binding ability and stability of AML1. The CBF $\beta$  protein increases the DNA binding ability of AML1 (Ogawa et al. 1993; Wang et al. 1993). Furthermore, the CBF $\beta$  protein protects AML1 from the ubiquitylation and subsequent proteasome-mediated proteolysis (Huang et al. 2001). The ubiquitously expressed ALY protein also increases the AML1 DNA binding ability on the TCR $\alpha$  enhancer. Similarly, ALY interacts with the LEF-1 transcription factor which is also presents in the AML1 transcriptional complex and increases its DNA binding ability (Bruhn et al. 1997). Furthermore, the YAP protein increases the AML1 mediated transcriptional activation of the osteocalcin promoter but the YAP influence on the AML1 DNA binding ability has not been studied (Yagi et al. 1999).

An important group of non-DNA binding proteins interacting with AML1 is histone acetyltransferases (HATs). HATs catalyze transfer of the acetyl groups onto lysine residues of histones. Acetylation of histones triggers conformational changes in chromatin, which adopts an open conformation and becomes more accessible for the transcriptional machinery. Acetylation is a widely used mechanism of transcriptional regulation (reviewed by Blobel 2000) AML1 interacts with p300 and CBP (CREB binding protein) (Kitabayashi et al. 1998) that are highly homologous proteins, possessing an intrinsic HAT activity (Ogryzko et al. 1996) and, moreover, bind other HATs (Yang et al. 1996). Furthermore, p300 and CBP interact with basal transcriptional factors (Kwok et al. 1994). AML1 physically interacts with p300 and CBP and p300 increases the AML1 mediated activation of the myeloperoxidase promoter (Kitabayashi et al. 1998; Kitabayashi et al. 2001). Moreover, p300 acetylates AML1. This modification enhances the AML1 DNA-binding ability and stimulates its transcriptional activity (Yamaguchi et al. 2004). It has also been shown that the promyelocytic leukemia (PML) nuclear protein stimulates functional cooperation between AML1 and p300 (Nguyen et al. 2005).

MOZ (monocytic leukemia zinc finger protein) is another transcription coactivator which possesses an intrinsic HAT activity (Champagne et al. 2001). MOZ physically interacts with AML1 and enhances the AML1 mediated transcription from the myeloperoxidase promoter (Kitabayashi et al. 2001). Furthermore, MOZ and AML1 cooperate to activate the macrophage inflammatory protein-1 $\alpha$  promoter (Bristow and Shore 2003). The acetylation of AML1 by MOZ has also been shown (Kitabayashi et al. 2001). Interestingly, like AML1, the MOZ

gene is involved in chromosomal translocations associated with different types of leukemia (Borrow et al. 1996; Liang et al. 1998; Kitabayashi et al. 2001).

For a long time, AML1 has been considered exclusively as a transcriptional activator. However, its transcriptional repressing capacity is also established now. AML1 transcription repression is firstly mediated via the Groucho/TLE corepressor interaction (Aronson et al. 1997; Javed et al. 2000). Members of the Groucho/TLE family of corepressor proteins do not interact with DNA but form transcription repressive complexes with DNA-binding proteins. The mechanism of the Groucho/TLE-mediated repression is not fully understood but it is conceivable that they recruit histone deacetylases (HDACs) to DNA. HDACs catalyse removing of the acetyl groups from lysine residues of histones what stabilizes interaction between histones and DNA. This restores transcriptionally inactive status of chromatin and shuts down transcription (reviewed by Chen and Courey 2000). The five most C-terminal amino acids of AML1 (VWRPY) are necessary for physical interaction between AML1 and Groucho/TLE. The fact that this amino acid sequence is conserved across all members of the Runx family underscores their significant biological role (Aronson et al. 1997). Co-transfection of the AML1 and Groucho/TLE expressing plasmids significantly decreases the level of reporter genes expression whose transcription is driven by various AML1 responsive promoters/enhancers (TCR $\alpha$  and  $\beta$  enhancers, M-CSF promoter (Imai et al. 1998; Levanon et al. 1998)). Physical interaction between AML1 and some of the HDAC family members further support the model for HDAC mediated AML1 repression of transcription (Durst et al. 2003).

The AML1 mutants lacking the C-terminal VWRPY amino acids cannot interact with Groucho/TLE. It has been found however that this prevents repression of transcription of several but not all target genes (Aronson et al. 1997). This finding suggests the existence of Groucho/TLE-independent mechanisms involved in AML1 mediated transcription repression. Subsequent studies confirmed that repression of the p21 promoter by AML1 occurs via the mSin3A corepressor interaction (Lutterbach et al. 2000). Physical interaction between AML1 and mSin3A has been demonstrated and its regulation by the AML1 phosphorylation has also been shown (Lutterbach et al. 2000; Imai et al. 2004). mSin3A binds to dephosphorylated AML1 and the complex comes apart upon the AML1 phosphorylation (Imai et al. 2004). The C-terminal VWRPY amino acids are not necessary for the association between AML1 and mSin3A. The putative mechanism of the mSin3A mediating

transcriptional repression looks similar to the Groucho/TLE mediating one. mSin3A does not bind DNA, but interacts with DNA binding transcriptional factors. Furthermore, mSin3A forms a complex with HDACs recruiting them to DNA that promotes transcriptional repression (reviewed by Knoepfler and Eisenman 1999). The fact that the HDACs inhibitor impairs the p21 promoter repression mediated by the AML1 and mSin3A interaction further supports this model (Lutterbach et al. 2000).

Taken together, the following model of AML1 mediated transcriptional regulation may be suggested (see Figure 2). AML1 interaction with other transcriptional factors facilitates the binding of the *Runt* domain to DNA. Depending on the cellular context, DNA bound AML1 interacts with different types of non-DNA binding proteins, which may recruit either HATs or HDACs. HATs catalyze acetylation of histones disrupting chromosome structure and stimulating transcription. HDACs catalyze the reverse process of the histones deacetylation restoring closed chromatin structure and shutting down transcription. According to that, the cellular context determines whether the AML1 dependent transcription is activated or repressed. In line with this model the AML1 represses the p21 promoter in the 3T3 cells, but activates the same promoter in the K562 cells (Lutterbach et al. 2000). Mechanism of the AML1 dependent promoters' regulation remains to be further investigated.

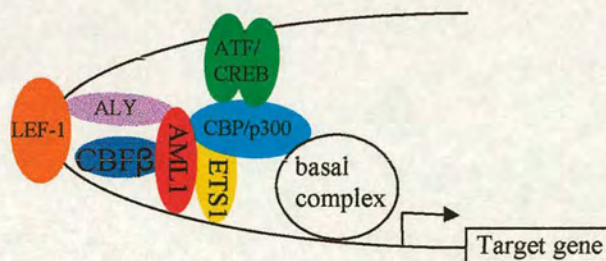
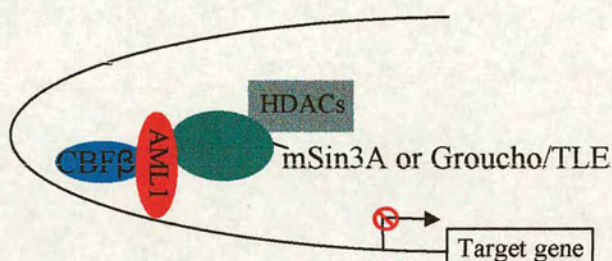
**A****B**

### Figure 2. Transcriptional complex formation by AML1

**A.** Schematic representation of a model of the AML1 mediated transcriptional activation. AML1 DNA binding is facilitated by other DNA binding transcription factors (for instance, ETS-1, LEF-1). The LEF-1 protein induces bending of DNA (Giese et al. 1995). The non-DNA binding proteins either stabilize the transcriptional complex (ALY, CBF $\beta$ ) or recruit HATs and basal transcriptional factors. p300/CBP interacts with the CREB/ATF transcriptional factors (Chrivia et al. 1993).

**B.** Schematic representation of a model of the AML1 mediated transcriptional repression. AML1 binds DNA and interacts with either mSin3A or Groucho/TLE corepressor which recruit HDACs. The involvement of other DNA binding transcriptional factors in the repressive complex is also possible but is not shown.

The diagrams are simplified; not all proteins involved in the AML1 transcriptional complex are shown.

## 1.4. The role of AML1 in a mouse embryonic development

### 1.4.1. Hematopoietic differentiation *in vivo*

Hematopoietic stem cells (HSCs) lie at the foundation of the haematopoietic system. These cells reside mainly in the bone marrow in the adult organism (see Figure 3). HSCs are capable of self-renewing and multipotent myeloid, erythroid and lymphoid differentiation. The HSCs population comprises only about 0.05% of the total number of bone marrow cells (reviewed by Morrison et al. 1995). This small cell population continuously supplies differentiating haematopoietic cells into the blood stream (reviewed by Morrison et al. 1995; Kondo et al. 2003). Markers expressed in HSCs are shared with other haematopoietic cells. Therefore, only a functional transplantation assay is the ultimate test that allows reliable identification of HSCs (reviewed by Domen and Weissman 1999). To determine if a given cell population contains HSCs the cells are transplanted into myeloablated recipient. Irradiation of mice at about 950 Rad causes efficient myeloablation followed by the death of the animal due to severe anaemia. Transplanted HSCs function in recipient animals over a period of more than 4-6 months and therefore can rescue the animals. Other *in vitro* assays allow identification of different mature hematopoietic progenitors (reviewed by Domen and Weissman 1999).

First blood cells in the mouse appear in E7.5 yolk sac (Moore and Metcalf 1970). This initial population mainly consists of large nucleated erythrocytes. It has been shown that the yolk sac before E10 is not capable of reconstitution of adult recipients hematopoietic systems (Harrison et al. 1979; Sonoda et al. 1983; Muller et al. 1994). Therefore, E7.5-E10 yolk sac does not contain definitive HSCs. It is suggested that first embryonic blood cells represent a transient cell population serving only immediate needs of an embryo (Dzierzak and Medvinsky 1995). Only by E11 the first transplantable HSCs emerge in the embryo in the area of the dorsal aorta, genital ridge/gonads and pro/mesonephros region (AGM region) (Muller et al. 1994; Medvinsky and Dzierzak 1996). Sites of HSCs generation were also found in vitelline and umbilical arteries in E10.5 (de Bruijn et al. 2000). Slightly later, by E11 definitive HSCs appear in yolk sac and the foetal liver (Muller et al. 1994). In order to assess the potential of various embryonic tissues to generate HSCs; an organ culture method was used in order to preserve intracellular interactions within explants. Using the method tissue explants dissected from the embryo were cultured for 2 or 3 days. Dissociated cells from the cultured explants were transplanted into irradiated recipients. It has been shown that E10 AGM region was the only tissue

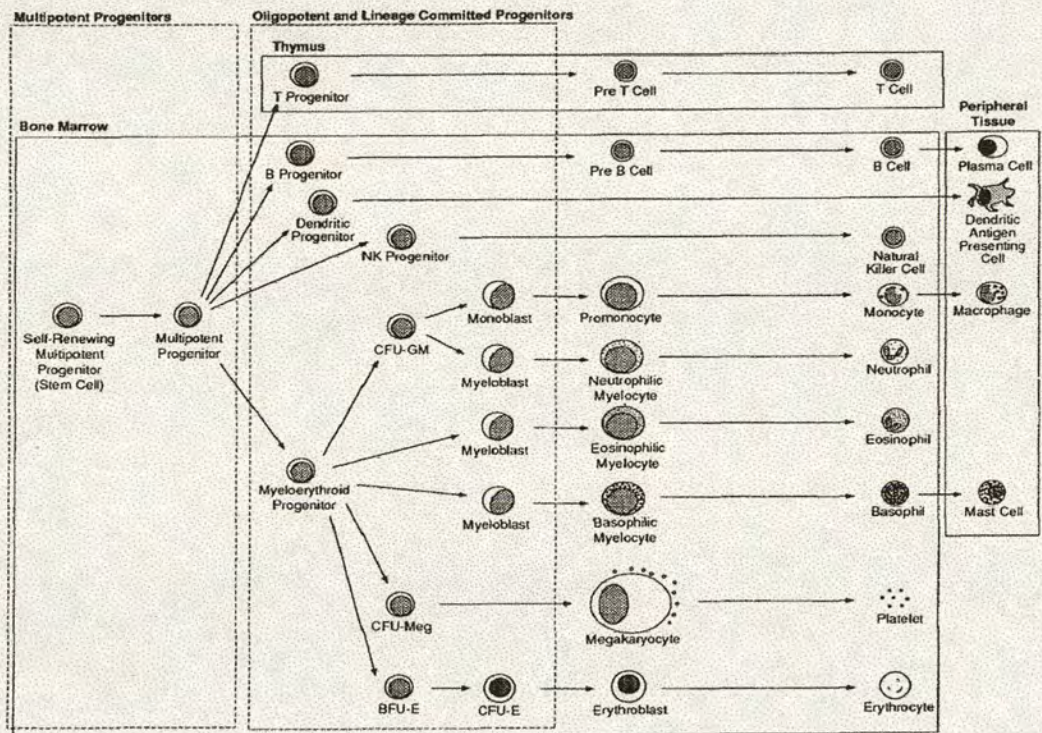

**Figure 3. Schematic representation of the multilineage differentiation of hematopoietic stem cells in bone marrow (Morrison et al. 1995)**

Multipotent bone marrow HSCs have the ability to maintain themselves (self-renewal) and differentiate into any type of blood cells. HSCs produce progenitor cells with restricted differentiation potential which terminally differentiate into mature blood cells. Hematopoietic progenitors with restricted differentiation potential are designated as colony-forming units (CFU) - granulocyte/macrophage (GM), - megakaryocyte (Meg) and - erythroid (E) depending on which type of blood cells they are committed. BFU-E (burst forming unit - erythroid) represent more immature erythroid progenitors than CFU-E (Stephenson et al. 1971). NK designates nature killer.

which initiated cells capable of long-term repopulation at this time (Medvinsky and Dzierzak 1996). Therefore, AGM has autonomous capacity to generate HSCs. The peak of HSC activity was detected in the AGM region on E11, but by the next day it is going down (Kumaravelu et al. 2002). It is interesting that by E12 the yolk sac acquires capacity to expand HSCs, suggesting that it also contributes in formation of the definitive haematopoietic system. It is widely accepted that HSCs are not generated *de novo* in foetal liver but arrive from extra-hepatic sources (Johnson and Moore 1975). It has been suggested that HSCs emerging in AGM or yolk sac enter the circulation and colonize the foetal liver in two consecutive waves. The first wave of HSCs originating from the AGM region comes on E10-E12, whereas the second one arrives from yolk sac on E12-E13 (Kumaravelu et al. 2002) (see Figure 4). Simultaneously with colonisation of the foetal liver the number of HSCs is growing in embryonic blood. The foetal liver is the main hematopoietic site in the mouse foetus during E12-E16. From E16 HSCs colonise definitive haematopoietic territories, bone marrow and spleen (Delassus and Cumano 1996).

Earlier investigations of embryonic haematopoietic development led to an observation that hematopoietic cells are closely associated with the ventral part of the dorsal aorta endothelium (Garcia-Porrero et al. 1995). Several independent studies provide evidences that hematopoietic cells bud from the hemogenic endothelium lining the floor of the dorsal aorta, vitelline and umbilical arteries. In order to prove this, endothelial cells in the chicken embryo were labelled using different methods (Jaffredo et al. 1998; Jaffredo et al. 2000) and their progeny were later tracked. Hematopoietic clusters expressing the pan-haematopoietic marker CD45 attached to the floor of the dorsal aorta were found labelled with the fluorescent marker. It has also been shown that endothelial cells sorted on the basis of expression of the vascular endothelial cadherin (Breier et al. 1996) from the E9.5 mouse embryo gave rise to hematopoietic colonies after culturing with growth factors (Nishikawa et al. 1998). Cumulatively these data support the hypothesis firstly proposed more than 80 years ago that hematopoietic and endothelial cells have a common progenitor called “hemangioblast” (Sabin 1920; Murray 1932).

#### **1.4.2. AML1 is a regulator of the definitive hematopoiesis during mouse embryogenesis**

The AML1 knock-out mice have been independently generated by three groups (Okuda et al. 1996; Wang et al. 1996; Okada et al. 1998), AML1<sup>-/-</sup> embryos

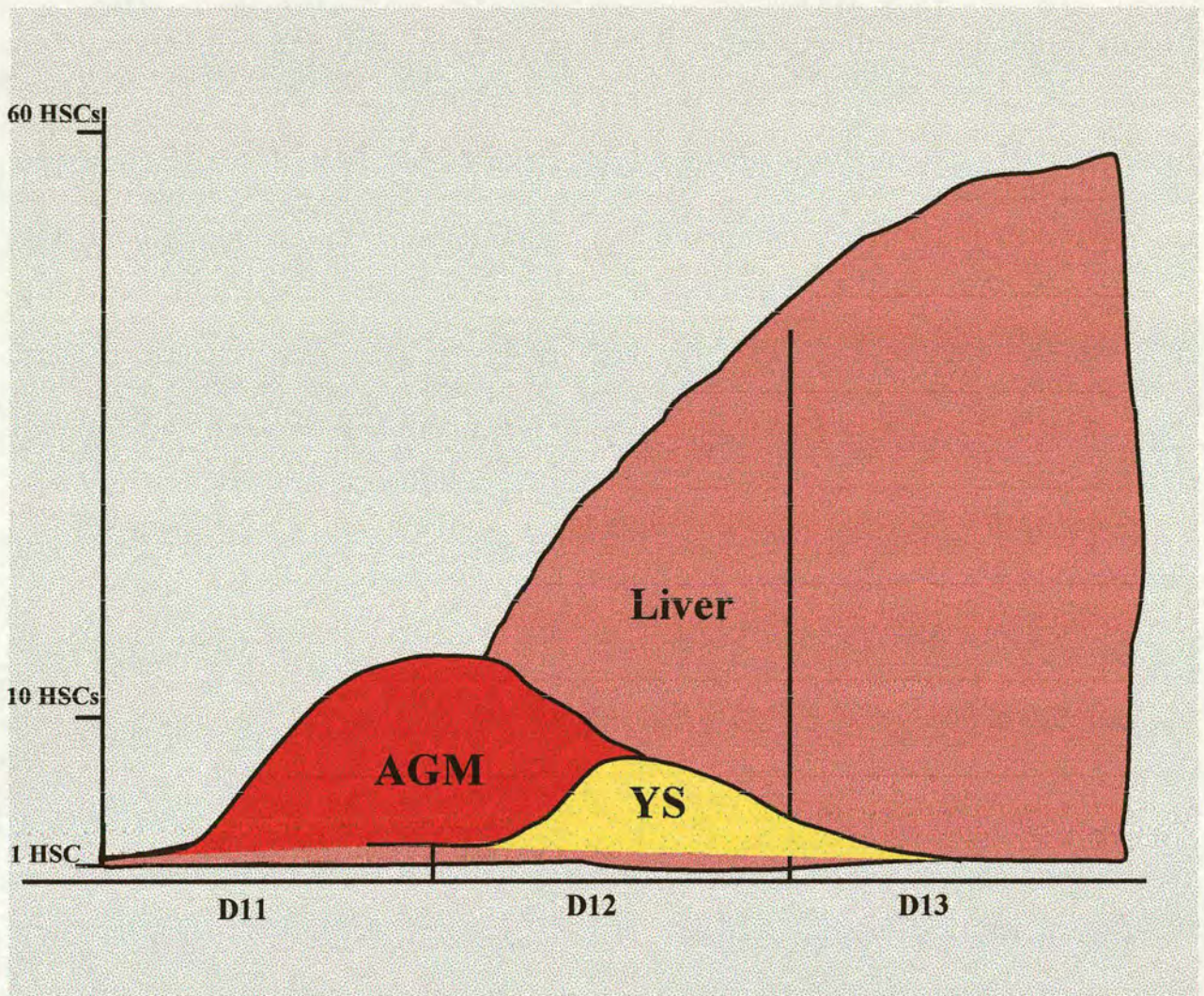

**Figure 4. Schematic representation of the HSCs distribution in hematopoietic tissues of a mouse embryo**

**(from Kumaravelu et al. 2002)**

First HSCs emerge in the E10-11 AGM region. They form the first wave of a foetal liver colonisation during E11-E12. The second wave comes from the yolk sac (YS) by E12-E13.

die between E11.5 and E12.5 from extensive haemorrhages in the nervous system and pericardium. Although the yolk sac hematopoiesis looks unaffected, hematopoietic progenitors are not developed in the foetal liver. Expression of a few hematopoietic specific genes are abolished in  $AML1^{-/-}$  embryos (Okada et al. 1998).  $CBF\beta^{-/-}$  phenotype is similar:  $CBF\beta^{-/-}$  embryos die on E11.5-E13.5 due to haemorrhage in the central nervous system. Foetal liver hematopoiesis is also severely impaired (Sasaki et al. 1996; Wang et al. 1996; Niki et al. 1997). However, while the foetal liver cells from the E11.5  $AML1^{-/-}$  embryos produced no hematopoietic colonies *in vitro*, the  $CBF\beta^{-/-}$  ones could generate a few of them (Wang et al. 1996). Subsequent studies have shown that  $AML1^{-/-}$  embryonic stem (ES) cells (see below) fail to develop hematopoietic colonies *in vitro* and do not contribute into hematopoietic tissues of chimeric mice (Okuda et al. 2000).

The influence of the  $AML1$  mutation on HSCs development was studied using the  $AML1$  reporter mouse strain (North et al. 1999). The  $LacZ$  reporter gene was targeted into the  $AML1$  locus, and the reporter was observed in all hematopoietic sites of the  $AML1^{LacZ/+}$  embryos (AGM, vitelline and umbilical arteries, yolk sac and foetal liver). Close association between  $LacZ$  positive hematopoietic and endothelial cells was observed in the ventral portion of the dorsal aorta, umbilical and vitelline arteries. E11.5 foetal livers from  $AML1^{LacZ/-}$  embryos failed to produce hematopoietic colonies *in vitro* (Okuda et al. 1996; Wang et al. 1996; Okada et al. 1998). In line with that FACS (fluorescence activated cell sorting) analysis demonstrated that the E11.5  $AML1^{LacZ/-}$  foetal liver expressed significantly decreased level of cell surface markers associated with haematopoietic differentiation. Since no  $LacZ$  positive cells were found in the blood of the  $AML1^{LacZ/-}$  embryos, it has been proposed that  $AML1$  knock-out embryos fail to generate HSCs in the AGM region. Comparison of the  $LacZ$  expression in the dorsal aortas of the  $AML1^{LacZ/+}$  and  $AML1^{LacZ/-}$  embryos showed that both of them contained  $LacZ$  positive cells in the endothelial and para-aortic mesenchymal cells of E9.5 embryos. However, by E10.5  $LacZ$  expression increased in the endothelium and was accompanied with appearance of  $LacZ$  positive haematopoietic cells in the aortic lumen of the  $AML1^{LacZ/+}$  embryos in contrast to  $AML1^{-/-}$  embryos. Interestingly, mesenchymal but not endothelial cells express  $LacZ$  in the E11.5 dorsal aorta suggesting that  $AML1$  marks a transient population of hemogenic endothelial cells.  $LacZ$  positive cells sorted out from the  $AML1^{LacZ/+}$  embryos reconstituted lethally irradiated recipients whereas  $LacZ$  negative ones failed to do this (North et al. 2002). Therefore,  $AML1$  may be a positive regulator of the generation of definitive HSCs.

Its expression in the hemogenic endothelium may be essential for development of the definitive hematopoietic system. Since HSCs express AML1 it suggests its essential role in HSC functioning. Further experiments studying the role of AML1 in hemangioblast formation and differentiation are in line with this idea.

Cells isolated from the AGM region of the E9.5 AML1<sup>-/-</sup> embryos failed to generate hematopoietic cells *in vitro* whereas cells isolated from wild type embryos produced them successfully. However, the endothelial-like structures were generated *in vitro* from AGMs of embryos of both genotypes (Mukoyama et al. 2000). Endothelial cells sorted out from E10.5 AML1<sup>-/-</sup> embryos also failed to produce hematopoietic colonies *in vitro*. AML1 expression in the wild type endothelial cells was confirmed by the reverse transcription – polymerase chain reaction (RT-PCR) suggesting the AML1 role in acquisition of the hematopoietic potential by endothelial cells. Interestingly, although both AML1<sup>-/-</sup> and wild type cells produced endothelial colonies *in vitro*, the number of colonies generated by the knock-out cells was slightly higher (Yokomizo et al. 2001). The intermediate population between endothelial and hematopoietic cells has been described using CD45 pan-haematopoietic and VE-cadherin endothelial markers (Fraser et al. 2003). Both endothelial and hematopoietic markers are expressed in this population which is capable of generating VE-cadherin negative CD45 positive cells *in vitro*. This intermediate cell population was sorted out from wild type E9.5 embryos. In contrast, AML1 knock-out embryos lacked this population (Fraser et al. 2003). Cumulatively these data suggest that AML1 is one of the key regulators of development of the definitive haematopoietic system in the mammalian embryo.

#### **1.4.3. The role of AML1 in the vascular network development**

Extensive haemorrhages observed in the AML1<sup>-/-</sup> embryos imply that it may be involved in the vascular development regulation. Blood vessels may be generated by either vasculogenesis or angiogenesis. Vasculogenesis implies *de novo* formation of blood vessels from angioblasts whereas during angiogenesis new vessels are generated from pre-existing ones (reviewed by Patan 2000). Analysis of angiogenesis in the AML1<sup>-/-</sup> embryos has shown that they contain less branches and small capillaries by E11 than wild type littermates (Takakura et al. 2000). In accord with that AML1<sup>-/-</sup> AGMs from E9.5 embryos generate less developed vascular network *in vitro* than the wild type AGMs. However, this defect can be rescued by supplementation of either wild type HSCs or angiopoietin-1 to the culture. Based on

these experiments the role of HSCs in vasculogenesis has been proposed (Takakura et al. 2000). Angiopoietin-1 signalling plays an essential role in vascular development (reviewed by Ward and Dumont 2002) Interestingly, angiopoietin-1 expression in the HSCs has been demonstrated (Phillips et al. 2000; Takakura et al. 2000). Since in the absence of AML1 HSCs are not generated, angiopoietin-1 is not provided for growing vessels, what may cause underdevelopment of the vascular network in AML1<sup>-/-</sup> embryos.

The functional interplay between angiopoietin-1 and AML1 has been further shown during investigation of the angiogenic activity of MSS31 cells overexpressing the CBF $\beta$ -SMMHC (Namba et al. 2000). The MSS31 cell line was established from spleens of newborn mice. These cells demonstrate properties of endothelial cells (Yanai et al. 1991). CBF $\beta$ -SMMHC is a fusion of the CBF $\beta$  and smooth muscle mysin heavy chain (SMMHC) proteins. This chimeric gene was cloned from a chromosomal inversion found in patients with AML (Liu et al. 1993). The CBF $\beta$ -SMMHC protein acts as a dominant negative inhibitor of AML1. The CBF $\beta$ -SMMHC knock-in mice phenotype is very close to the AML1 knock-out one (Castilla et al. 1996). The level of the angiopoietin-1 expression was significantly decreased in the CBF $\beta$ -SMMHC overexpressing MSS31 cells suggesting again that AML1 may be a positive regulator of the angiopoietin-1 gene expression (Namba et al. 2000). Furthermore, the tube formation and cell migration *in vitro* of the MSS31 cells were significantly reduced when CBF $\beta$ -SMMHC was overexpressed. Therefore, AML1 is likely to be involved in vascular endothelial network formation.

AML1 is a putative regulator of several angiogenesis-related genes. AML1 activates transcription of the endothelial specific puromycin-insensitive leucyl-specific aminopeptidase (PILSAP) gene in MSS31 cells (Niizeki et al. 2004). It is also a putative activator of endogenous vascular elastase (EVE) in vascular smooth muscle cells (Wigle et al. 1998; Mitani et al. 2000). Both PILSAP and EVE play an important role in angiogenesis promoting proliferation and migration of endothelial or vascular smooth muscle cells (reviewed by Rabinovitch 1999; Sato 2003). Furthermore, expression of the insulin-like growth factor-binding protein-3 (IGFBP-3), a putative inhibitor of angiogenesis is downregulated upon AML1 expression in endothelial AEL- $\Delta$ R cells derived from E11.5 AML1<sup>-/-</sup> embryos (Iwatsuki et al. 2004). AML1 induction results in (i) enhancement of the vascular network formation *in vitro*, (ii) activation of the endothelial marker VE-cadherin expression and (iii) downregulation of the IGFBP-3 gene expression. Since AML1<sup>-/-</sup> embryos contain

VE-cadherin positive cells (see above, Fraser et al. 2003) it is unlikely that VE-cadherin is an AML1 target gene. More likely upregulation of its expression may demonstrate the endothelial differentiation enhancement. IGFBP-3 protein belongs to a family of proteins acting as regulators of insulin-like growth factors (IGF) (reviewed by Delafontaine et al. 2004). The inhibitory influence of IGFBP-3 on endothelial cells proliferation was shown (Delafontaine et al. 1996; Franklin et al. 2003). AML1 interacts with the IGFBP-3 promoter and represses it. Supplementation of AML1 expressing AEL- $\Delta$ R cells with the IGFBP-3 protein inhibits vascular network formation *in vitro* (Iwatsuki et al. 2004). Taken together, all this data unambiguously show that AML1 is involved in the regulation of angiogenesis; however detailed mechanisms are yet to be investigated.

#### **1.4.4. Hematopoietic differentiation *in vitro*: ES cell model**

All experimentations with transgenic mice have essential limitations which may be caused by embryonic lethality, poor accessibility of early precursor cell populations and necessity of prolonged animal breeding. Some of these limitations can be circumvented by modelling of differentiation *in vitro* using embryonic stem (ES) cells. ES cell lines are derived from the inner cell mass of the E3.5 blastocysts (Evans and Kaufman 1981; Martin 1981). These cells are pluripotent since they can give rise to any cell type. Undifferentiated ES cells can be maintained continuously *in vitro* if the LIF (leukaemia inhibitory factor) cytokine is added to the medium (Gearing et al. 1988; Smith et al. 1988; Williams et al. 1988). If undifferentiated ES cells are injected back into a blastocyst they can contribute to all cell types of the animal (Bradley et al. 1984). Withdrawal of LIF from the ES cell culture medium induces differentiation. Differentiation is further enhanced in three-dimensional aggregates formed in suspension culture (so-called, embryoid bodies, EBs) (Doetschman et al. 1985).

Molecular mechanisms governing the ES cells self-renewal and differentiation have been highlighted during the last years. First, the STAT3 transcription factor has been identified as a downstream effector molecule of the LIF-activated signalling pathway (Niwa et al. 1998). Second, an independent ES self-renewal promoting signalling pathway has been discovered (Ying et al. 2003). This pathway is induced by the BMP (bone morphogenetic protein) ligand molecule. ES cells can be propagated in the serum-free medium if both LIF and BMP are supplied. The BMP signalling causes the Id (inhibitor of differentiation) gene

expression. The Id molecules role is not clarified fully yet, but it is conceivable that it precludes the neural differentiation factors functioning. Two intracellular proteins have been identified as ES cell self-renewal determinants. The Oct4 transcription factor is necessary for the ES cells pluripotency maintenance (Nichols et al. 1998). ES cells differentiation, transdifferentiation or self-renewal *in vitro* is Oct4 dose-dependent (Niwa et al. 2000). Nanog is another ES cell protein which acts as the self-renewal positive regulator. Nanog overexpressing ES cells may self-renew if the LIF signalling is blocked (Chambers et al. 2003).

ES cells can differentiate into various cell types *in vitro* if appropriate culture conditions are applied (reviewed by Keller 1995; Smith 2001). Hematopoietic differentiation of ES cells has been performed in a semi-solid medium containing 0.9% methylcellulose (Wiles and Keller 1991). Methylcellulose provides a three-dimensional matrix which is supportive for developing EBs. The medium is further supplemented with various cytokines and growth factors promoting hematopoietic differentiation *in vitro*. Different ES cell differentiation media have been developed but most of them share erythropoietin, interleukins (IL-3 and IL-6), M-CSF, G-CSF (granulocyte colony-stimulating factor) and SCF (stem cell factor) (Wiles and Keller 1991; Keller et al. 1993). A method of the ES cells hematopoietic differentiation *in vitro* using two-dimensional cultures has also been developed (Nishikawa et al. 1998; Fraser et al. 2002). The two-step method is based on fetal liver kinase-1 (Flk-1) expression, Flk-1 is a transmembrane tyrosine kinase which serves as a receptor for vascular endothelial growth factors (Matthews et al. 1991; Quinn et al. 1993). Flk-1 is a marker of late mesodermal and early endothelial and hematopoietic cells (Yamaguchi et al. 1993; Shalaby et al. 1995; Eichmann et al. 1997). ES cells were precultured in LIF-free medium on type IV collagen-coated plates for four days. After that Flk-1 positive cells were sorted out from the predifferentiated ES cells to eliminates inhibitory effects which other germ layers may exert on hematopoietic differentiation (Kessel and Fabian 1987) and plated onto OP9 feeder cells in presence of erythropoietin, SCF and IL-3 (Nishikawa et al. 1998; Fraser et al. 2002; Fraser et al. 2003). OP9 stromal cells established from calvaria of a newborn knock-out mouse which lacked functional M-CSF (Nakano et al. 1994) efficiently induce hematopoietic differentiation in ES cells.

AML1 expression level is rather low in undifferentiated ES cells and EBs during first days of differentiation. However it grows gradually from the third day of differentiation (Fujita et al. 2001; Lacaud et al. 2002). AML1<sup>-/-</sup> EBs generate fewer

blast colonies giving rise to both endothelial and hematopoietic cells than the wild type EBs (Kennedy et al. 1997; Choi et al. 1998). The blast colonies are considered to represent the putative hemangioblast stage. This defect of the AML1<sup>-/-</sup> EBs has been rescued by the AML1 expressing retrovirus infection (Lacaud et al. 2002). Interestingly, AML1<sup>-/-</sup> blast colonies demonstrate that they have potential to differentiate into endothelial and primitive erythroid lineages but not into myeloid or definitive erythroid cells (Okuda et al. 1996; Lacaud et al. 2002). These experiments suggest that AML1 plays an important role in specification of the haemangioblast.

## **1.5. The role of AML1 in adult hematopoiesis**

### **1.5.1. Introduction**

Since the AML1<sup>-/-</sup> embryos do not survive, the conditional knock-out strategy has been employed in order to investigate functions of AML1 in adult hematopoiesis (Ichikawa et al. 2004). A genetically modified mouse strain with the AML1 exon 5 surrounded by *loxP* sites was generated and bred with the Mx1-Cre transgenic mice. The Mx1-Cre transgenic mice encode Cre recombinase driven by the inducible Mx1 promoter and induce efficient recombination in different cell types (Kuhn et al. 1995). The Mx1 promoter is inducible by interferons (Chang et al. 1991; Finkelman et al. 1991). Upon endogenous interferons induction by synthetic double-stranded RNA, Cre catalyses excision of the *loxP* sites flanking DNA fragment in the AML1 genomic locus in double transgenic mice (see the Chapter 2.2 for the detailed discussion of the Cre recombinase and conditional knock-out strategies). After recombination the AML1 allele encodes the protein whose ability to bind DNA is abolished. However, the TA domain remains unaffected and may exert a biological effect. Furthermore, this experimental design does not perturb expression of AML1 minor isoforms lacking the exon 5.

In addition two other transgenic mouse strains with EGFP and LacZ reporters targeted into the AML1 locus have been instrumental for biological analysis of AML1 (North et al. 1999; Lorsbach et al. 2004; North et al. 2004).

### **1.5.2. The role of AML1 in the HSCs functioning**

The highest level of AML1 expression is observed in the HSC enriched bone marrow fractions (Lorsbach et al. 2004; North et al. 2004). It has been shown using AML1<sup>LacZ/+</sup> reporter mouse strain that AML1 marks HSCs. LacZ positive cell population sorted out from bone marrow of AML1<sup>LacZ/+</sup> mice reconstitutes the hematopoietic system of lethally irradiated recipients whereas LacZ negative population fails to do so. Furthermore, LacZ positive bone marrow cells from AML1<sup>LacZ/+</sup> animals generate many more hematopoietic colonies *in vitro* than the LacZ negative cells (North et al. 2004). The AML1 function in HSCs is not clear yet; however it is conceivable that AML1 may have an inhibitory influence on proliferation of immature hematopoietic progenitors. Bone marrow AML1<sup>-/-</sup> cells

produce elevated numbers of myeloid, mixed (myeloid and erythroid) and megakaryocytic colonies *in vitro* compared to wild type cells. Similarly, the number of undifferentiated hematopoietic, early megakaryocytic and lymphocytic progenitors determined by the surface marker staining is also increased in the AML1<sup>-/-</sup> bone marrow cells. The colony-replating capacity of the AML1<sup>-/-</sup> bone marrow cells is also elevated (Ichikawa et al. 2004).

### 1.5.3. The role of AML1 in the megakaryocytic development

AML1<sup>-/-</sup> mice have significant defects in platelet development. The number of platelets in the peripheral blood is significantly decreased after the knock-out inducer injection. The histochemical analysis of the AML1<sup>-/-</sup> bone marrow revealed no normal megakaryocytes but immature megakaryocyte-like cells instead of them (Ichikawa et al. 2004). The important role of AML1 in the megakaryocytic development has been further evidenced by discovering physical interaction and functional cooperation between AML1 and a common erythro-megakaryocytic transcription factor GATA-1. However, whereas the GATA-1 expression is detected in both erythroid and megakaryocytic cells, AML1 displays significant levels of expression in megakaryocytes only (Elagib et al. 2003). The levels of the GATA-1 expression in human hematopoietic progenitor undergoing erythroid or megakaryocytic differentiation *in vitro* are increased. In contrast, AML1 expression is elevated only during megakaryocytic differentiation. The human leukemic cell line K562 recognized as common erythro-megakaryocytic progenitors (reviewed by Alitalo 1990) shows elevated levels of the AML1 protein expression upon induction of the megakaryocytic differentiation (Elagib et al. 2003). Interestingly, the activity of an IRES in the AML1 proximal 5' UTR in the K562 cells is enhanced upon the megakaryocytic differentiation induction (Pozner et al. 2000). Furthermore, the AML1 overexpression induces the K562 cells to the megakaryocytic differentiation (Elagib et al. 2003). These results suggest that AML1 may act at a level of a common erythro-megakaryocytic progenitor as a positive regulator of the megakaryocytic differentiation. It is conceivable that at early steps of differentiation it may not be essential since the megakaryocyte-like cells have been found in the AML1<sup>-/-</sup> bone marrow. However, the AML1 gene seems to be indispensable during the later stages of the megakaryocytic differentiation, since the platelet generation is impaired and immature megakaryocytic progenitors accumulate in the AML1<sup>-/-</sup> bone marrow (Ichikawa et al. 2004). Interestingly, mutations in the AML1 gene have been found in patients affected with the familial platelet disorder, an autosomal dominant

hereditary disease characterised by the platelet defects (Song et al. 1999; Michaud et al. 2002).

#### **1.5.4. The role of AML1 in the erythrocytes development**

It seems that AML1 is only marginally involved in the erythroid cells differentiation. The AML1 expression in differentiating erythrocytes is very weak or undetectable (Lorsbach et al. 2004; North et al. 2004). There is no difference in the number of erythroid colonies generated from AML1<sup>-/-</sup> and wild type bone marrow cells *in vitro*. Furthermore, the haemoglobin level has not been changed in the mouse peripheral blood upon the excision in the AML1 gene locus (Ichikawa et al. 2004). However, the AML1 expression has been detected in early erythroid progenitors (Lorsbach et al. 2004; North et al. 2004). Furthermore, the downregulation of an erythroid specific gene HERF1 in the AML1<sup>-/-</sup> ES cells has been shown (Harada et al. 1999). The possible involvement of AML1 in the early erythroid differentiation needs further investigations.

#### **1.5.5. The role of AML1 in the granulocytes and monocytes development**

The role of AML1 in granulocyte and monocyte development has not been fully investigated so far. Presumably, AML1 may play a role in development of these cells, but its role is not crucial. There is no significant difference in the peripheral blood neutrophil counts between the AML1<sup>-/-</sup> and wild type mice. The AML1<sup>-/-</sup> bone marrow cells could reconstitute properly the granulocytic and monocytic compartments of the lethally irradiated recipients (Ichikawa et al. 2004). At the same time, several research groups demonstrated the possible involvement of AML1 in the granulocytes and monocytes differentiation *in vitro*. The 32D murine myeloid progenitor cell line grows in presence of IL-3 and differentiates into neutrophils upon the G-CSF addition (Migliaccio et al. 1989). The AML1B isoform overexpressed in the 32D (clone 3) cells enhanced proliferation of the immature neutrophil progenitors in the presence of G-CSF whereas the AML1C isoform overexpression had no effect on the 32D cells (Telfer and Rothenberg 2001). However, there is a contradiction between these data and an earlier publication reporting no influence of the overexpressed AML1B isoform on the 32D (clone 3) cells proliferation or differentiation (Tanaka et al. 1995). U937 human lymphoma cells differentiate into monocyte-like cells upon retinoid acid treatment (Olsson and Breitman 1982), which is accompanied by increased expression of AML1 (Tanaka et al. 1995). However,

functional significance of this has not been studied. Furthermore, AML1 regulates transcription of the neutrophil elastase and myeloperoxidase gene which are the early markers of granulopoiesis (Nuchprayoon et al. 1994; Li et al. 2004). The promoter of the monocyte specific M-CSF receptor is also can be activated by AML1 (Zhang et al. 1994; Zhang et al. 1996; Petrovick et al. 1998).

### **1.5.6. The role of AML1 in lymphocyte development**

AML1 is involved in the lymphocyte development, since the lymphocyte count in blood of the AML1<sup>-/-</sup> mice is decreased. Furthermore, the AML1<sup>-/-</sup> bone marrow cells in contrast to wild type cells do not repopulate B- and T-cell compartments of lethally irradiated recipients (Ichikawa et al. 2004).

#### **1.5.6.1. The role of AML1 in the B-cells development**

AML1-mediated activation of a few B-cell specific promoters has been reported: (i) AML1 cooperates with the early B-cell factor protein and activates the early B-cell specific promoter mb-1 (Maier et al. 2004), (ii) AML1 activates transcription of the B-cell specific protein kinase BLK (Libermann et al. 1999). The AML1 physical interaction and functional cooperation with the B-cell specific transcriptional factor PAX5 in the BLK promoter activation has been also reported (Libermann et al. 1999). Furthermore, AML1 binds to the B-cell specific  $\mu$  enhancer (Erman et al. 1998).

It has been shown that the AML1 is capable of activation of transcription of the B-cell specific I $\alpha$ 1 germ line promoter. The expression of immunoglobulin heavy chains may be switched in mature B-cells upon antigen activation. The switch occurs via site-specific recombination between so-called switch regions in the immunoglobulin heavy chain locus. Transcription from heavy chain promoters is necessary and precedes recombination between switch regions in the gene. The accessibility of chromatin to the recombination machinery associated with changes in its structure is a mechanism controlling the time and site of recombination. The promoter/enhancer regions activating transcription of germ line transcripts are designated as I (intervening) (reviewed by Stavnezer 2000).

The transforming growth factor (TGF)- $\beta$ 1 induces transcription from the I $\alpha$ 1 germ line promoter that precedes the immunoglobulin class A heavy chain switch.

TGF- $\beta$ 1 interacts with extracellular domains of the transmembrane receptor serine/threonine protein kinase, what triggers conformational changes in the receptors and phosphorylation of the Smad intracellular signalling molecules. Upon phosphorylation, Smads trimerize and translocate into the nucleus where they interact with DNA and promote formation of active transcriptional complexes (reviewed by Moustakas et al. 2001; Derynck and Zhang 2003). The *I $\alpha$ 1* promoter contains both the *Runt* domain and Smads binding sites (Zhang and Derynck 2000). AML1 activates the *I $\alpha$ 1* promoter in the lymphoid DG75 and erythromegakaryocytic K562 cell lines (Xie et al. 1999). AML1 physically interacts with Smad proteins that enhances transcription from the *I $\alpha$ 1* promoter in K562 and HepG2 cells (Hanai et al. 1999; Pardali et al. 2000; Zhang and Derynck 2000). Functional cooperation between AML1 and Smads increases responsiveness of cells to TGF- $\beta$ 1 (Pardali et al. 2000; Zhang and Derynck 2000). In line with that subnuclear colocalization of the AML1 and Smads proteins has been shown (Zaidi et al. 2002). Interestingly, the AML2 protein exerts the similar effect on the *I $\alpha$ 1* promoter (Shi and Stavnezer 1998; Hanai et al. 1999; Zhang and Derynck 2000). Thus further investigations are required to clarify the specific role of individual members of the AML family in the *I $\alpha$ 1* promoter regulation.

#### **1.5.6.2. The role of AML1 in the T-cells development**

Thymus is an organ where the level of AML1 expression is highest in adult mice (Satake et al. 1995), suggesting its important role in T-cells development. Most of T-cells belongs to either cytotoxic or helper subclass distinguished by their specific coreceptors expressed on the cell surface. Cytotoxic cells express the CD8 coreceptor whereas helper cells express the CD4 molecule. T-cell development can be divided in three major stages. The most immature thymocytes are CD4<sup>-</sup> CD8<sup>-</sup> double negative (DN) cells. According to expression of CD44 and CD25 surface molecules development of DN cells is further subdivided into double-negative stages 1 to 4 (DN1, 2, 3, 4) (Pearse et al. 1989; Godfrey et al. 1993). During the CD44<sup>+</sup> CD25<sup>-</sup> DN1 and CD44<sup>+</sup> CD25<sup>+</sup> DN2 stages thymocytes gradually restrict their differentiation potential becoming irreversibly committed to the T-cell lineage at the CD44<sup>-</sup> CD25<sup>+</sup> DN3 stage. At the DN3 stage TCR $\beta$  locus rearrangement starts. The cells in which in-frame TCR $\beta$  rearrangement has occurred are selected for further maturation ( $\beta$ -selection) (Dudley et al. 1994; Hoffman et al. 1996). At the CD44<sup>-</sup> CD25<sup>-</sup> DN4 stage TCR $\alpha$  rearrangement starts and finishes at the CD4<sup>+</sup>CD8<sup>+</sup> double positive (DP) stage (Godfrey et al. 1994). If the DP cells express the TCR $\alpha\beta$

heterodimer, they undergo subsequent rounds of positive and negative selection and only cells with intermediate affinity to the MHC (major histocompatibility complex) class I or II molecules survive. T-cells selected with the MHC class I molecules differentiate into mature CD8<sup>+</sup> single positive (SP) cytotoxic cells, whereas cells selected with the MHC class II molecules differentiate into CD4<sup>+</sup> SP helper cells. Thus, the interaction with the MHC molecule governs the lineage choice in the DN thymocytes; however details of this mechanism remain unclear (reviewed by Rothenberg 2002; Gill et al. 2003).

The transition from the DN2 to DN3 stage is blocked in AML1<sup>-/-</sup> thymocytes generated by the chemically induced Cre-mediated excision in the AML1 locus (Ichikawa et al. 2004). Furthermore, in other research the excision in the AML1 locus has been catalysed by Cre driven by the T-cell specific Lck promoter (Taniuchi et al. 2002). The Lck gene encodes a tyrosine protein kinase belonging to the Src family. Lck is involved in signal transduction in thymocytes (reviewed by Zamoyska et al. 2003). The transition from the DN3 to DN4 stage in AML1<sup>-/-</sup> thymocytes is blocked if Cre is driven by the Lck promoter (Taniuchi et al. 2002). The difference in the stage of the T-cell maturation block may be explained by delayed Cre expression in the Lck-Cre mice. Several important regulatory genes acting at the DN and DP stages are targets of AML1. First, AML1 is a regulator of TCR $\alpha$ ,  $\beta$ ,  $\gamma$  and  $\delta$  enhancers activity (Redondo et al. 1991; Hsiang et al. 1993; Hernandez-Munain and Krangel 1994; Wotton et al. 1994; Giese et al. 1995; Sun et al. 1995; Bruhn et al. 1997). As in the case with the immunoglobulin heavy chain rearrangement, transcription from TCR promoters is necessary and precedes TCR rearrangement. It has been shown that mutations in the TCR $\delta$  enhancer preventing the AML1 binding significantly impaired TCR rearrangement (Lauzurica et al. 1997). Rag-1 and 2 (recombination activation genes) catalyse rearrangements in the TCR loci. It has been shown that native Runt domain binding sites in the Rag-1, 2 silencer are essential for proper regulation of Rag-1 and 2 genes expression (Yannoutsos et al. 2004) Further investigations are necessary to understand which of three AML proteins is involved in regulation of RAGs. CD4 is expressed at low level in most immature thymocytes. The CD4 expression is controlled by the CD4 promoter/enhancer and silencer. AML1 binding sites have been found in the silencer. Experiments with knock-out mice showed that AML1 (but not AML2 or 3) is necessary for the CD4 gene repression at the DN stage (Taniuchi et al. 2002). CD4 may be repressed via the Groucho/TLE dependent mechanism since the AML1

cDNA lacking the C-terminal VWRPY amino acids causes expansion of CD4 positive cells (Nishimura et al. 2004).

The mechanism of CD4 repression may be different in the DN and CD8 SP cells. It is thought that in contrast to active repression in the DP cells CD4 becomes epigenetically and therefore irreversibly silenced in CD8 SP cells. The same *Runt* domain binding sites in the CD4 silencer are responsible for silencing in both DN and CD8 SP cells. However, it is AML2 which is required for silencing of CD4 in CD8 SP cells and further maturation of cytotoxic T-cells. It has been shown that CD4 in the AML2<sup>-/-</sup> mature thymocytes is partially derepressed (Taniuchi et al. 2002). CD4 is fully derepressed in the thymocytes of the compound AML1<sup>+/-</sup> AML2<sup>-/-</sup> mice and therefore these both genes cooperate in differentiation of CD8 SP cells (Woolf et al. 2003).

Terminally differentiated SP CD4 and CD8 cells enter bloodstream and leave thymus becoming naïve peripheral T-cells. Further differentiation steps are necessary for the generation of mature T-helper (Th) and cytotoxic cells. The AML1 involvement in the naïve CD4<sup>+</sup> cells differentiation was shown (Komine et al. 2003). Naïve CD4<sup>+</sup> cells may differentiate towards either Th1 or Th2 subclass. Th1 and Th2 cells produce different cytokines and act on different types of effector cells (reviewed by Grogan and Locksley 2002). AML1 inhibit the Th2 cell lineage differentiation, promoting maturation of the Th1 cells. AML1 is a negative regulator of GATA-3 which is a key transcription factor in Th2 cells (reviewed by Murphy and Reiner 2002).

## 1.6. Functional role of individual isoforms of AML1

The AML1 gene locus encodes a number of alternatively spliced isoforms. The expression pattern, functional significance and regulation of expression of individual isoforms are not well understood. The available data on this issue arrived mainly from the analysis of the four individual isoforms: AML1A, AML1B, AML1C and AML1 $\Delta$ N (see Figure 1).

The AML1B and C isoforms belong to the long isoforms subgroup. They have both *Runt* and TA domains and may activate and repress transcription of target genes. These isoforms differ in their N-termini since AML1B is transcribed from the proximal promoter whereas AML1C is transcribed from the distal promoter (Miyoshi et al. 1995; Ghozi et al. 1996). Proximal transcripts are initiated from exon 3; whereas the distal ones are initiated from exon 1 followed by exon 2 and the 3' segment of exon 3. The splice acceptor site of the exon 3 is located 13 nucleotides downstream of the initiator ATG codon of the proximal transcripts. Therefore, the 5 most N-terminal amino acids of the exon 3 are missing in the AML1C protein but the whole protein is longer than the AML1B, since the AML1C translation is initiated by an ATG codon located in the exon 1. AML1C contains 27 extra amino acids as compared to AML1B (Miyoshi et al. 1995). Functional significance of this difference is not clear. However, different influence of AML1B and C isoforms on the neutrophilic differentiation has been shown by overexpression in 32D cells (Telfer and Rothenberg 2001).

The AML1A and  $\Delta$ N isoforms are the short isoforms. They contain either *Runt* (AML1A) or TA (AML1 $\Delta$ N) domains. Both of them cannot activate transcription of target genes (Meyers et al. 1995; Zhang et al. 1997). The AML1 $\Delta$ N isoform is transcribed from the distal promoter, therefore it encodes exon 1. There is an internal splice donor site within the exon 1 which is joined to a splice acceptor site within exon 4 during the AML1 $\Delta$ N transcript splicing. Translation of the AML1 $\Delta$ N protein is initiated by an ATG located within the exon 4. Therefore, the AML1 $\Delta$ N protein does not contain the functional *Runt* domain and represents an N-truncated short isoforms. Accordingly, AML1 $\Delta$ N neither bind DNA nor interacts with the CBF $\beta$  protein. The AML1 $\Delta$ N coexpression interferes with reporter gene activation mediated by AML1B in a few cell lines presumably by sequestering co-factors forming active transcription complex with long AML1 isoforms. AML1 $\Delta$ N

expression has been found in a hematopoietic cell line at the level lower than long isoforms (Zhang et al. 1997).

The polyadenylation signal for the short AML1A isoform termination of transcription is located within the exon 7A, whereas polyadenylation signals involved in the termination of long isoforms transcription are located within the exon 8 (Miyoshi et al. 1995). Therefore, AML1A isoform does not contain the TA domain encoded by exons 7B and 8 which are located downstream exon 7A. Of note, exon 7A is spliced out from the long isoforms transcripts. This exon encodes nine C-terminal amino acids of the AML1A protein (Miyoshi et al. 1995). Whether this sequence play any functional role is unknown. Since AML1A encodes the *Runt* domain it binds DNA and heterodimerizes with the CBF $\beta$  protein, but it is not capable of activating transcription of target genes due to absence of the TA domain (Bae et al. 1994; Meyers et al. 1995; Tanaka et al. 1995; Aziz-Aloya et al. 1998). Interestingly, the AML1A isoform shows higher affinity to the AML1 binding site than AML1B (Tanaka et al. 1995). AML1A is a minor isoform which expression could not be detected by the Northern blot hybridization using exon 7A as a probe (Miyoshi et al. 1995). As a result there is virtually no data on expression analysis of the AML1A isoform.

Experiments aiming to investigate the functional role of the AML1A short isoform suggest that it may act as a dominant negative inhibitor of the long isoforms. It has been shown that the long AML1B isoform transfected into the P19 murine embryonal carcinoma (EC) cell line activated transcription of a reporter gene but the AML1A isoform cotransfection reduced the levels of the reporter gene expression (Tanaka et al. 1995). Similar results have been shown in C33A human cervical carcinoma cells. Activation of a reporter gene by long AML1C isoform has been reduced by cotransfection with the short AML1A isoform (Meyers et al. 1995).

Therefore it is conceivable that AML1 long isoforms which have both *Runt* and TA domains and are capable of activating transcription of hematopoietic specific genes may act as positive regulators of hematopoietic differentiation. The AML1 short isoforms (especially, the AML1A isoform) may act as dominant negative regulators promoting self-renewal. I set out to test this hypothesis by generating a system in which overexpression of AML1 individual isoforms can be achieved in ES cells. Since these ES cells may be differentiated into hematopoietic cells, overexpression of various AML isoforms will allow me to study their roles in

haematopoietic development. Various experimental systems for gene overexpression are discussed in the next chapter.

## **Chapter 2: INTRODUCTION**

### **Experimental systems for gene expression in ES cells**

#### **2.1. Constitutive gene expression**

Constitutive expression of a gene of interest in ES cells is normally achieved by stable DNA transfection. The cDNA of interest is usually followed by a drug resistance gene for the stable transfectants selection. However, each stable transfectant is generated by a unique random integration event that entails significant variations in the levels of expression between clones which depends on surrounding genetic context. Furthermore, exogenous DNA may create insertional mutations resulting in unpredictable expression of endogenous genes. Both of these problems may be by-passed by using extrachromosomal (episomal) vectors for cDNA expression. Episomal vectors are circular double-stranded DNA molecules which are maintained in cells by extrachromosomal replication. Both *cis* and *trans* acting regulatory elements are necessary for the episomal vectors replication. The vector bears *cis* acting elements, whereas *trans* regulatory element(s) is usually integrated into genome of a host cell line (reviewed by Van Craenenbroeck et al. 2000). Transfection of the episomal vector in such cell line is called “supertransfection”. Usually, episomal vectors encode a drug resistance gene ensuring the drug selection of supertransfectants. An episomal molecule can be maintained indefinitely in cells if the appropriate drug selection is applied (Gassmann et al. 1995). Transfection of episomal vectors is highly efficient and generates supertransfectants homogenous in the levels of cDNA expression. This accounts for successful application of these vectors in gain-of-function expression studies and functional screens (Aubert et al. 2002; Chambers et al. 2003).

#### **2.2. Conditional gene expression**

##### **2.2.1. Conditional gene activation using Cre recombinase**

Conditional gene expression systems have had a profound impact on gene function studies during the last decade. They proved invaluable in modelling various disease and research related to developmental biology and functional genetics. A significant disadvantage of a conventional gene targeting technology is that no research on adult animals can be done in the case of embryonic lethality. One way of avoiding this is to ablate (or to induce) gene expression in a specific tissue or at a definite developmental stage. *Cre/loxP* technology proved to be a useful tool for this.

Cre (causes recombination) is the phage P1 site-specific recombinase (Sternberg and Hamilton 1981). It catalyses recombination between two 34 bp (base pairs) sites called *loxP* (locus of crossingover). Each *loxP* site consists of two 13 bp inverted repeats separated by an 8 bp spacer region. The spacer region confers directionality to a *loxP* site. Co-orientation of two *loxP* sites before recombination determines the structure of the recombination product. Cre does not require any ancillary phage or bacterial proteins for its function. Therefore, it has been successfully used in eukaryotic cells to mediate recombination between *loxP* sites incorporated both into chromosomal and extrachromosomal DNA (Sauer and Henderson 1988; Gu et al. 1994). When two *loxP* sites are introduced into the genome in direct (head-to-tail) orientation and flank a genomic sequence, Cre expression causes excision of the floxed (flanking by *loxP* sites) fragment. The excised DNA fragment contains one *loxP* site and forms a circle. At the place of excision remains a single *loxP* site. The circular fragment lacks centromeres and quickly disappears since it cannot be maintained in the cells. If *loxP* sites have inverted (head-to-head or tail-to-tail) orientation, Cre catalyses inversion of the floxed fragment without excision.

Conditional gene activation is achieved by placing a floxed stop cassette between a promoter and a coding sequence. As a result the transgene remains dormant. However, its expression can be achieved by Cre-mediated excision. Differential temporal and spatial expression of Cre predetermines time and place of activation of the dormant transgene. In the simplest case, Cre is driven by a tissue-specific promoter making the transgene active in a particular cellular compartment only (Lakso et al. 1992). Other strategies employ chemical induction of either the Cre transgene transcription (Schneider et al. 2003) or translocation of Cre protein from the cytoplasm to the nucleus (Brocard et al. 1997; Kellendonk et al. 1999). Cre-mediated activation of the transgene has been successfully employed in a large number of studies.

### **2.2.2. Conditional gene activation using chemical induction**

The Cre/*loxP* system allows conditional activation or inactivation of the gene of interest; however its further expression cannot be controlled. Other systems such as tetracycline-inducible systems offer more flexible control of regulation of gene expression. Such systems may also be useful for gene therapy applications. Currently, three systems (RU486, ecdysone and tetracycline gene inducible systems) are most widely used. All three systems contain two distinct genetic elements

incorporated into the cell. Such binary inducible systems contain a transcription activator driven by a tissue-specific promoter which is functional only in presence of an externally added small inducing molecule. Upon chemical induction active transcription activator binds to the second (responsive) element within the promoter which drives a gene of interest. The optimal inducible system must fulfil the following requirements (i) no expression of a reporter gene unless an inducer is added, (ii) high concentration-dependent magnitude in levels of expression of the gene of interest, (iii) no interference with cellular metabolic pathways.

### **2.2.2.1. RU486 (mifepristone) gene expression system**

The RU486 (mifepristone) gene inducible system is based on the mutated human progesterone receptor (see Figure 5A). Progesterone is a steroid hormone which is involved in various biological functions. It is a lipophilic molecule which crosses the cell membrane and binds to the progesterone receptor in cytoplasm. Upon progesterone binding, the receptor undergoes conformational changes, enters the nucleus, homodimerizes and activates transcription of the promoter which contains the progesterone responsive element (PRE) (reviewed by Leonhardt et al. 2003). Progesterone antagonist RU486 (or mifepristone) acts as an inducer in this system. In addition this system uses a human progesterone receptor deletion mutant called PR-891. The PR-891 mutant does not bind the endogenous progesterone, but becomes active upon interaction with RU486 (Vegeto et al. 1992). Since the PR-891 mutant receptor may activate any PRE-containing promoter it has been modified (Wang et al. 1994). The modified receptor contains only the PR-891 ligand binding (LB) domain fused to non-mammalian DNA-binding (DB) and transactivation (TA) domains (see Figure 5A). For that, yeast DB Gal4 domain which binds the 17 bp upstream activation sequence (UAS) (Giniger et al. 1985) and the herpes simplex virus (HSV) VP16 TA domain (Triezenberg et al. 1988) were used. Since the UAS-containing mammalian promoters are not known, the activation is expected to be specific. The functionality of the new chimeric transactivator called GLVP (Gal4 – LBD – VP16) was tested by cotransfection with a CAT (chloramphenicol acetyl transferase) reporter plasmid containing a promoter with four UAS. A little or no CAT activity was observed in the absence of RU486; however, its administration induced 10-20 fold reporter activity. Since RU486 is clinically used as a progesterone antagonist a concern was raised about its possible antiprogestin effect *in vivo*. However, it has been shown that RU486 upregulates a reporter at

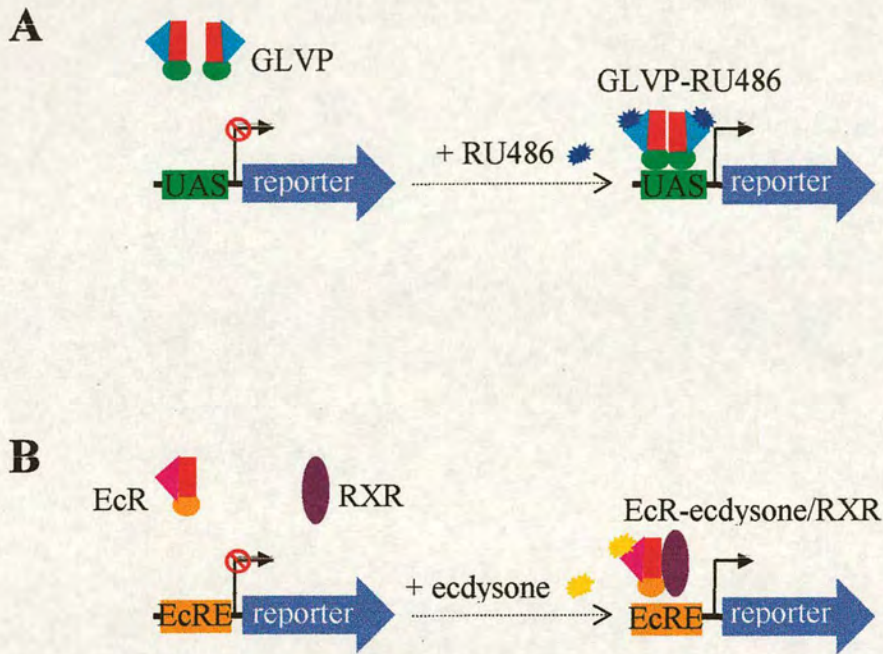

**Figure 5. Schematic representation of RU486 and ecdysone gene inducible systems**

**A.** RU486 gene inducible system. Transcriptional transactivator GLVP consists of the GAL4 DB (green circle), VP16 TA (red rectangle) and PR-891 LB (cyan triangle) domains. Upon the RU486 (blue star) addition, GLVP dimerizes, binds to the UAS (green rectangle) containing promoter and activates transcription of a reporter gene.

**B.** Ecdysone gene inducible system. Ecdysone receptor (EcR) contains DB (orange circle), LB (pink triangle) and heterologous VP16 TA (red rectangle) domains. Upon the ecdysone (yellow star) binding, EcR heterodimerizes with the RXR protein (violet oval). The heterodimer interacts with the EcRE containing promoter (orange rectangle) and activates transcription of a reporter gene.

concentration considerably lower than required for its physiological antagonistic activity (Wang et al. 1994).

Since the first publication by Wang et al, the RU486 gene expression system was further improved and tested both *in vivo* and *in vitro* (Wang et al. 1997; Wang et al. 1997; Burcin et al. 1999). The goal of these studies was to modify GLVP in the way that it would gain lower background activity, higher fold activation and responsiveness to lower concentration of RU486. A more potent version of GLVP was generated by making use of a further deletion in the LB domain. Simultaneously, it is active at lower concentration of RU486 (Wang et al. 1997). A very high level of a reporter induction was achieved *in vivo*. The human growth hormone reporter gene was upregulated 33000 fold by RU486 in compound transgenic mice with the liver-specific expression of GLVP (Wang et al. 1997). RU486 working concentrations are significantly lower than those that can cause physiological antiprogesterone effect *in vivo*. Furthermore, RU486 is quickly metabolised *in vivo* and as a result the level of a reporter expression decreases significantly over 3-5 days (Wang et al. 1997; Burcin et al. 1999).

#### **2.2.2.2. Ecdysone gene expression system**

The ecdysone gene expression system (see Figure 5B) is based on the insect hormone ecdysone which is a steroid hormone controlling critical developmental stages in *Drosophila melanogaster* (reviewed by Kozlova and Thummel 2000). Like RU486, ecdysone crosses the cytoplasmic membrane and binds to the cognate ecdysone receptor (EcR). Upon the ecdysone binding EcR forms a heterodimer with a co-factor the *Ultraspiracle* (USP) protein. The EcR/USP heterodimer interacts with the ecdysone responsive element (EcRE) containing promoters and activates transcription of appropriate genes. Ecdysone is transcriptionally active only in complex with the USP protein (reviewed by Mangelsdorf and Evans 1995; Buszczak and Seagraves 1998). An advantage of the ecdysone inducer is that it is not known as a transcriptional regulator of mammalian genes. Early experiments showed that cotransfection of EcR and USP rendered the ecdysone responsiveness to monkey cells, although only 3 fold activation of a reporter gene was obtained (Yao et al. 1992). The system was further improved, by replacement of the EcR TA domain with VP16 TA domain that provided better interaction between the receptor and the mammalian transcriptional machinery (No et al. 1996). The USP mammalian homologue RXR (retinoid X receptor) was also tested. Upon induction with

muristerone A (ecdysone analogue), the EcR/RXR heterodimer upregulated reporter activity by 212 fold. This system has also been tested *in vivo* and reporter induction was observed (No et al. 1996). Due to poor availability of the muristerone A, a large number of ecdysteroids was screened in order to identify a suitable inducer (Saez et al. 2000). As a result ponasterone A isolated from leaves of a widespread tree was found to be as a potent inducer of the ecdysone responsive genes both *in vivo* and *in vitro*. It induces genes specifically and fast (Albanese et al. 2000; Saez et al. 2000). A luciferase reporter was upregulated 100 fold by ponasterone A in the mouse skin (Saez et al. 2000). Therefore the ecdysone inducible system is characterised by low basal activity and non-interference with mammalian cellular metabolic pathways. Although the system may be very useful in gene expression studies; it has not been used a lot so far. Further studies on characterisation of the system are required.

### 2.2.2.3. Tetracycline gene expression system

The most widespread gene inducible system was generated by the Prof. Bujard group on the basis of the *E. coli* tetracycline resistance operon Tn10 (see Figure 6A). The operon consists of two oppositely directed genes TetA and TetR. The regulatory sequence encoding promoters and operators is located between 5' ends of the genes. TetR is a transcriptional repressor controlling the tetracycline resistance operon while TetA is a membrane pump exporting tetracycline from cells (reviewed by Hillen and Berens 1994). TetR binds to the tetracycline resistance operator sequences O1 and O2 and shuts down transcription of both TetA and TetR genes in the absence of tetracycline. Once tetracycline has penetrated into the cell, it acts as an inducer of the tetracycline resistance genes. Tetracycline interacts with the TetR protein inducing its conformational changes and dissociation from the operator DNA thereby triggering transcription of both TetA and TetR genes

The initial tetracycline regulatory (Tet-Off) system was generated for inducible repression of genes (Gossen and Bujard 1992) (see Figure 6B). The TetR repressor was converted to a transcriptional activator by fusing to the VP16 TA domain. This chimaeric regulator called tetracycline transactivator (tTA) was tested in cotransfection assays with a plasmid encoding the artificial tetracycline responsive promoter (TRP). TRP is composed of 7 repeats of the 19 bp O2 operator sequence upstream the minimal cytomegalovirus immediate early (CMV IE) promoter. Interaction with tetracycline induces conformational changes of tTA triggering its dissociation from a promoter and therefore the gene of interest remains

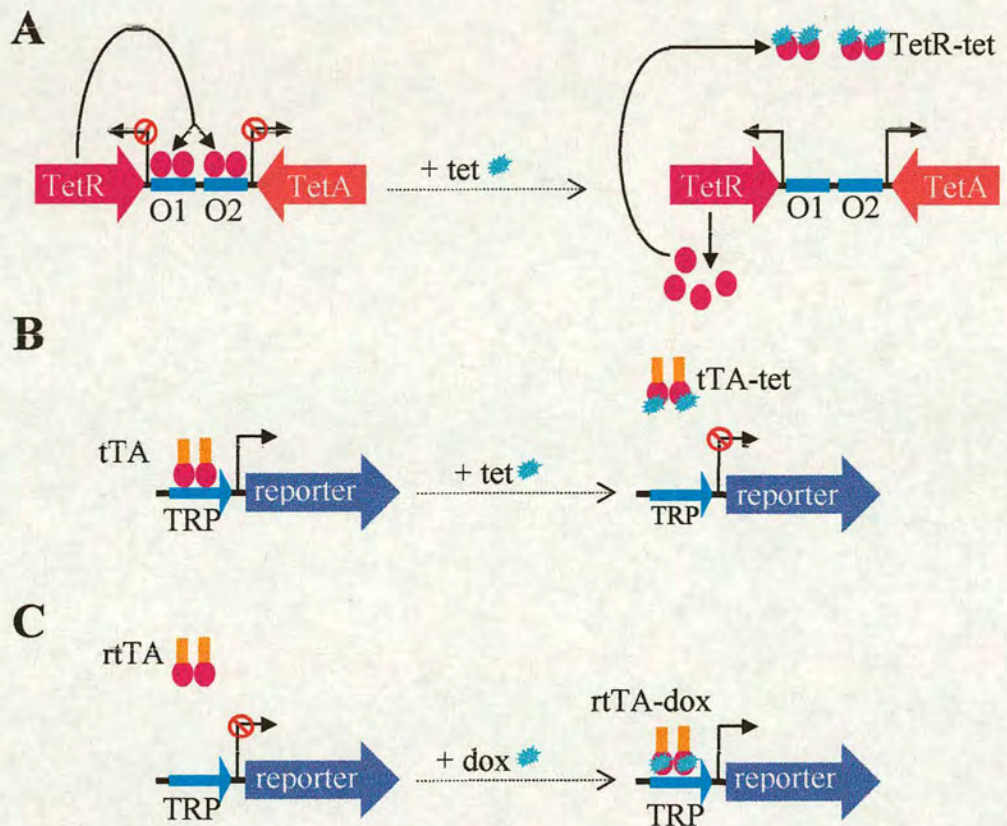

**Figure 6. Schematic representation of natural and artificial tetracycline responsive systems**

**A.** The tetracycline resistance operon. The TetR repressor (violet circle) binds to operator sequences (blue rectangles) and shuts down transcription of the TetR and TetA genes. Once tetracycline (blue star) is added, it complexes with TetR preventing its interaction with DNA and activating transcription.

**B.** Tet-Off system. tTA (the TetR repressor (violet circle) fused to the VP16 TA domain (orange rectangle)) activates transcription of a reporter gene driven by the tetracycline-responsive promoter (TRP) (blue arrows). TRP consists of the 7 repeats of the O2 operator sequence followed by the CMV IE minimal promoter. Tetracycline (cyan star) impedes the tTA binding with TRP thereby preventing the reporter gene transcription.

**C.** Tet-On system. Reverse tTA (rtTA) is transcriptionally inactive unless tetracycline (or doxycycline) is added. Therefore, there is no reporter expression in the absence of doxycycline; however it is induced once doxycycline is added.

inactive. Both regulatory and responsive plasmids were stably transfected into human HeLa cells. However, the levels of the luciferase reporter gene expression in the presence of tetracycline differed significantly between clones probably due to position effect. The withdrawal of tetracycline upregulated the luciferase activity in all clones up to 5 orders of magnitude. Expression of a reporter gene decreased in a dose-dependent manner upon the addition of tetracycline (Gossen and Bujard 1992).

Further development of the system led to generation of its Tet-On version with tetracycline acting as an inducer of the reporter gene transcription (see Figure 6C). The mutant reverse TetR (rTetR) which binds to DNA upon addition of tetracycline was fused to the VP16 TA domain. As a result a reverse transcriptional transactivator (rtTA) has been generated (Gossen et al. 1995). rtTA binds TRP and activates transcription only in the presence of tetracycline or its analogue doxycycline. Doxycycline induces a reporter gene more effectively than tetracycline and therefore has been used in all subsequent studies. However, rtTA tends to have background activity and furthermore, induces responsive promoters weaker than tTA. Accordingly, research aimed to isolate a more potent version of rtTA was undertaken (Urlinger et al. 2000). Firstly, TetR was fused to three minimal VP16 TA domains (VP16<sub>min</sub>) optimized for expression in human cells. VP16<sub>min</sub> lacks sites that potentially are capable of interaction with cellular proteins that reduced its cytotoxicity. As a result experiments with the TetR-VP16<sub>min</sub> fusion showed that HeLa cells became capable of tolerating higher TetR-VP16<sub>min</sub> concentrations (Baron et al. 1997). Secondly, a library of mutant TetR-VP16<sub>min</sub> has been generated and the mutants that showed positive regulation by tetracycline were selected. The most promising mutant rtTA2<sup>S</sup>-M2 contained four amino acid substitutions. It had no background activity in the absence of doxycycline, upregulated the reporter up to 4-5 orders of magnitude upon the doxycycline addition and activated the reporter expression in a dose-dependent manner. Importantly, rtTA2<sup>S</sup>-M2 induced the reporter at the lower concentration of doxycycline than all others regulators (Urlinger et al. 2000). Thus, rtTA2<sup>S</sup>-M2 is a new highly improved doxycycline-dependent reverse transactivator.

In contrast to tTA, which underwent significant modifications since its generation, TRP has not been changed considerably. Two minimal promoters (CMV IE and HSV TK (thymidine kinase)) were tested as a the 3' end part of TRP and the CMV IE promoter occurred the most highly inducible (Gossen and Bujard 1992; Freundlieb et al. 1997). Essential modification of TRP included construction of a

bidirectional TRP (bTRP) (Baron et al. 1995). bTRP consists of the O2 heptamer surrounded by two CMV IE minimal promoters in the head-to-head orientation. As a result, bTRP can activate simultaneous transcription of two independent genes flanking the promoter. Thus, the bTRP vectors can simultaneously drive expression of a gene of interest and a reporter gene (for instance, EGFP) (Hess et al. 2001; Krestel et al. 2001). The reporter gene provides a valuable tool to monitor expression of gene of interest.

Both Tet-Off and Tet-On systems were successfully tested *in vivo* (Kistner et al. 1996). Administration of doxycycline to animals carrying both the rtTA and TRP-reporter transgenes induced the reporter gene up to 5 orders of magnitude. Low background, high inducibility and using a non-toxic inducer promise successful use of the tetracycline gene expression system in various studies which aim to elucidate gene functions. The increasing number of reports further confirm versatility of the system (Mansuy et al. 1998; Shin et al. 1999; Legname et al. 2000).

## Chapter 3: MATERIALS AND METHODS

Analytical grade reagents were supplied by Sigma, Fisher and BDH Laboratory Supplies. Synthetic oligonucleotides were ordered from Oswell DNA Service (University of Southampton). dCT<sup>32</sup>P radioisotope was supplied by Amersham.

### 3.1. Molecular biology methods

Basic molecular biology techniques and solution preparation were carried out as recommended by (Sambrook et al. 1989).

#### 3.1.1. List of main solutions

6x DNA loading buffer: 0.25% bromophenol blue; 30% glycerol in water  
LB: 1% (w/v) tryptone (Difco); 0.5% (w/v) yeast extract (Difco); 85mM NaCl  
PBS (phosphate buffered saline): 0.01M phosphate buffer; 0.0027M potassium chloride; 0.137M sodium chloride, pH 7.4  
20x SSC (saline – sodium citrate): 3M NaCl; 0.3M sodium citrate  
1x TAE: 0.04M Tris-acetate; 0.001M EDTA  
0.5x TBE: 0.0045M Tris-borate; 0.001M EDTA  
TE: 10mM TrisHCl (pH 8.0); 1mM EDTA (pH 8.0)

#### 3.1.2. Cloning

##### 3.1.2.1. General remarks

Cloning procedures involved restriction digestion of plasmids, filling of 5' or removal of 3' protruding ends (if necessary), isolation of DNA fragments from agarose gel, ligation, transformation of bacterial cells and selection of desirable transformants. After each enzymatic treatment DNA was extracted using consecutively TE-saturated phenol pH 7.8 and phenol-chloroform (1:1), precipitated using two volumes of 96% ethanol, washed using 70% ethanol, air dried and dissolved in TE. Concentration of DNA fragments was determined by comparing the intensities of fragments fluorescence in UV with DNA standards following electrophoresis in 0.5-2% agarose gel. Agarose gel electrophoreses were set up using 1x TAE; 0.5 mgk/mL ethidium bromide was to added to gel. 0.5-1 µg of 1 kb DNA



ladder (Gibco BRL) was loaded on each gel as a size standard. DNA samples were loaded in 1x DNA loading buffer.

### **3.1.2.2. Restriction**

Plasmid DNA was digested using the appropriate restriction enzymes in 1x reaction buffer at conditions recommended by a manufacturer. Restriction enzymes were supplied by Roche and New England Biolabs.

### **3.1.2.3. 5' overhang nucleotides filling and 3' overhang nucleotides removal**

5' overhang nucleotides were filled in and 3' overhang nucleotides were removed using the T4 DNA Polymerase (New England Biolabs) in 1x T4 DNA Polymerase buffer (New England Biolabs) supplemented with the 4mM dNTPs mixture (Roche) and 50µg/mL BSA (New England Biolabs). 1U of the enzyme was added per 1 pmole of 5' ends. Reaction mixture was incubated at 12° C for 20 minutes, after that the reaction was stopped by heat inactivation at 75°C for 10 minutes.

### **3.1.2.4. Isolation of DNA fragments from agarose**

DNA samples were run in 1-2% agarose gel. A well was cut out before a band of interest and cast with 1% low melting temperature (LMT) agarose gel. Once LMT agarose gel solidified the electrophoresis was continued till the band of interest reached the center of the LMT agarose fragment. After that, the LMT agarose fragment was cut out and melted at 65°C for 10 minutes. DNA was consecutively extracted using TE-saturated phenol pH 7.8 (twice) and chloroform (twice), precipitated using one volume of isopropanol, washed using 70% ethanol, air dried and dissolved in TE.

### **3.1.2.5. Ligation**

Ligation was set up at the vector:insert molar ratio 1:4 using 1-5U of the T4 DNA ligase (Roche) in 1x T4 DNA ligase buffer and incubated at 4°C for 16 hours. A self-ligation control reaction was set up in parallel. For the oligonucleotide adaptor ligation, the 5'-CATTCCCCTCCCCTACGTAC-3' and 5'-GTAGGGGAGGGGAATG-3' complementary oligonucleotides were denatured at

95°C for 5 minutes and annealed by the slowly cooling till 45°C. The oligonucleotide adaptor was ligated to a vector using 5U of the T4 DNA ligase (Roche) in 1x T4 DNA ligase buffer at 37°C for 2 hours.

#### **3.1.2.6. Transformation of E. coli bacterial cells**

Epicurian Coli XL1-Blue competent cells (Stratagene) were transformed with 5-10% of the ligation reaction volume according the manufacturer's protocol and spread onto LB plates with 1.5% agar and 100 µg/mL ampicillin. The plates were incubated at 37°C for 14-16 hours.

#### **3.1.2.7. Screening of recombinant clones**

If the ligation reaction transformants gave at least 5 times more colonies than the self-ligation transformants, the colonies were screened for the presence of an insert by plasmid isolation and restriction digestion. In all other cases the colonies were screened by colony lift and hybridisation with the radioactive labelled cloning insert.

##### **3.1.2.7.1. Colony lifts**

The positively charged nylon membrane (Roche) was placed on the plates with bacterial transformants (master plates) for 1 minute and punctured to mark the orientation. The membrane was peeled off a plate and laid colony side up onto a new plate with LB 1.5% agar ampicillin and 100 µg/mL ampicillin. The plate with membrane was incubated at 37°C for 6-8 hours. After that, the membrane was peeled off a plate and incubated colonies side up on the Whatman 3M paper soaked in the denaturing solution (1.5M NaCl; 0.5M NaOH) for 5 minutes followed by the paper soaked in the neutralisation solution (1.5M NaCl; 0.5M TrisHCl pH 7.5) two times per 5 minutes, rinsed in 2x SSC, air dried and baked at 120°C for 30 minutes. Master plates were incubated at 37°C for 1-2 hours to let the bacteria recover.

##### **3.1.2.7.2. Hybridisation of the membrane with a radioactive probe**

The membrane was prehybridised in 10-15 mL of the Church-Gilbert buffer (0.25M sodium phosphate pH 7.2; 7% SDS) at 65°C for 1 hour in the Techne rotating oven. After that, 5 mL of the Church-Gilbert buffer containing the <sup>32</sup>P

labelled probe was added to the membrane. Hybridisation was carried out in the same conditions as prehybridisation. Unbound probe was washed out by 3-5 consecutive incubations with the washing solution (30mM sodium phosphate pH 7.2; 0.1% SDS) at 65°C for 20 minutes. After that, the membrane was wrapped in Saran wrap and exposed to the Kodak film in intensifying screens at -70°C for 1-2 hours. Positive colonies were selected, picked up from master plates, expanded and further verified by restriction digestion.

#### **3.1.2.7.3. Radiolabelling of DNA**

DNA fragments were labelled with using the Rediprime II random prime labelling system (Amersham) according the manufacturer's protocol. Uncorporated nucleotides were removed using the ProbeQuant G-50 microcolumns (Amersham). Probes were denatured at 95-100°C, chilled in liquid nitrogen and added to the hybridisation buffer.

#### **3.1.2.8. Isolation of plasmid DNA**

Plasmid DNA was purified from 3-100 mL of overnight culture of a single bacterial colony in the LB medium with 100 µg/mL ampicillin. Isolation of plasmid DNA was performed using the minispin and maxiprep kits (Qiagen) according the manufacturer's protocol. Structure of isolated plasmid was verified by restriction digestion.

#### **3.1.2.9. Site-directed mutagenesis**

Site-directed mutagenesis was performed using the GeneEditor *in vitro* site-directed mutagenesis system (Promega) according the manufacturer's protocol with the 5' phosphorylated mutagenic oligonucleotide 5'-pTGTGATGTGTATCCCCGTAG-3'. Mutant plasmids were screened by sequence using the AML1 gene specific primer 5'-TGGAAGGCGGCGTGAAG-3'.

#### **3.1.2.10. TA cloning of PCR products**

PCR cycling was followed by the incubation at 72°C for 7 minutes for the 3' A-overhangs addition. After that, an aliquot of PCR products was analysed by electrophoresis in 1% agarose gel. The PCR products were cloned into the pCR2.1

vecotor using TA cloning kit (Invitrogen) according the manufacturer's protocol. Transformed bacteria were plated into plates with the LB 1.5% agar medium supplemented with 100 µg/mL ampicillin and 40 mkL each of 100mM IPTG and 40 mg/mL X-gal spread over plates. The plates were incubated at 37°C for 16 hours. Plasmids isolated from three white bacterial colonies were sequenced using the T7 primer 5'-TAATACGACTCACTATAGGG-3'.

### 3.1.3. DNA sequencing

Sequence was performed by David Kivlichan and Jil Lowell (The University of Edinburgh) using the BigDye dideoxy termination sequencing kit and a Perkin Elmer ABI-Prism automated DNA sequencer. Sequences were analysed using the ChromasPro and GeneRunner software.

### 3.1.4. PCR (polymerase chain reaction)

PCR reaction were set up using either 10 µg of a plasmid or 100 µg of the genomic DNA template, 10 pmoles of each primer, 0.2 mM dNTPs and 2.5 U of Taq DNA polymerase (Qiagen) in 1x PCR buffer (Qiagen). All PCR reactions were carried out on Biometra UNOII Thermocycler. The PCR reaction with the genomic DNA template was denatured at 94°C for 3 minutes before the Taq DNA polymerase addition. Cycling conditions and sequenced of primers were as follows.

External hybridization probe for the AML1/rtTA regulatory ES cells and mice genotyping

Template: the pAML42 plasmid

Primers: 5'-AAGTTGAAAGCATGGGGG-3' (forward) and 5'-TAATACGACTCACTATAGGG-3' (reverse)

25 cycles: 94°C 30 sec, 51°C 30 sec, 72°C 1 min.

Neo<sup>f</sup> hybridisation probe for the regulatory ES cells genotyping

Template: the pLNeo<sup>f</sup>L plasmid

Primers: 5'-CTGTGCTCGACGTTGTCAC-3' (forward) and 5'-AGCTCTTCAGCAATATCACG-3' (reverse)

25 cycles: 94°C 30 sec, 59°C 30 sec, 72°C 40 sec.

Exon 3 AML1 hybridisation probe for the responsive mice genotyping

Template: the pXba3 plasmid

Primers: 5'-CTTGTGTGATGCGTATCC-3' (forward) and 5'-GTCTTGTTCAGCGCCA-3' (reverse)

30 cycles: 94°C 30 sec, 57°C 30 sec, 72°C 40 sec.

The reaction mixture was supplemented with 1x Q-solution (Qiagen)

238 bp fragment encoding the *loxP* site in Ainv15 cells

Template: genomic DNA isolated from the Ainv15 cells

Primers: 5'-TTTGACCTCCATAGAAGACACCG-3' (forward) and 5'-AGCCGATTGTCTGTTGTGCC-3' (reverse)

40 cycles: 94°C 30 sec, 57°C 30 sec, 72°C 30 sec.

PCR products were analysed on a 1% agarose gel in 1x TAE. 0.5-1 µg of 1 kb DNA ladder was loaded on each gel as a size standard.

### **3.1.5. Isolation of DNA fragments for pronuclear microinjections**

DNA fragments for pronuclear microinjections was electroeluted from agarose gel using the Elutrap Electro-Separation system (Schleicher&Schuell) according the manufacturer's protocol, precipitated using two volumes of 96% ethanol, washed using 75% ethanol, air dried and dissolved in TE.

### **3.1.6. Southern blot hybridisation**

#### **3.1.6.1. Isolation of genomic DNA from ES cells and animal tissues**

ES cells were grown to confluence into 12- or 6-well plates, rinsed with PBS and lysed with lysis buffer (100mM TrisHCl pH 8.5; 5mM EDTA; 0.2% SDS; 200mM NaCl; 100 µg/mL proteinase K (Roche)) or the lysis buffer was added to tail or ear biopsies. Both cell and tissue lysates were incubated at 55°C for 16 hours. DNA was extracted with TE-saturated phenol-chloroform (1:1) and precipitated with equal volume of isopropanol, washed with 75% ethanol, air dried and dissolved in TE. Concentration of DNA fragments was determined by comparing the intensities of fragments fluorescence in UV with DNA standards following electrophoresis in 1.5% agarose gel.

### **3.1.6.2. Restriction digestion of genomic DNA**

5-10 µg of genomic DNA were digested with 50U of either Afl II (NEB) or Eco RV (Roche) restriction enzyme in the appropriate 1x restriction buffer. BSA (final concentration 100 µg/mL) was added to the Afl II restriction reactions. The reactions were incubated at 37°C for 20-24 hours.

### **3.1.6.3. Electrophoresis**

Electrophoresis in 0.7% agarose gel 1xTAE pH 7.5-7.8 was performed for 16 hours at 1 V/cm. 0.5-1 µg of 1 kb DNA ladder was loaded on each gel as a size standard. 10x DNA loading buffer was added to each restriction reaction before loading.

### **3.1.6.4. Blotting**

Genomic DNA was transferred from agarose gel onto the Hybond-N<sup>+</sup> nylon membrane (Amersham) by the download transfer in the TurboBlotter apparatus (Schleicher&Schuell) according the manufacturer's protocol. DNA transfer was performed in the alkaline transfer buffer (0.4M NaOH; 0.6M NaCl) for 16 hours at room temperature. After transfer a membrane was rinsed 3 times for 5 minutes in 2x SSC and baked at 80°C for 2 hours.

### **3.1.6.5. Hybridization.**

Membranes were prehybridised in 15 mL of the Church-Gilbert hybridization buffer (0.5M [Na<sup>+</sup>]PO<sub>4</sub> pH 7.0; 7% SDS; 2mM EDTA; 100 µg/mL denatured heterologous DNA) at 65°C for 3-24 hours in the Techne rotating oven. Hybridisation was performed in 15 mL of the Church-Gilbert buffer with the <sup>32</sup>P radiolabelled probe at 65°C for 16 hours on a rotator. Unbound probe was washed out by 3-5 consecutive incubations in the washing solution (0.2x SSC; 0.1% SDS) at 65°C for 15-20 min. After that, the membrane was wrapped in Saran wrap and either exposed to the Kodak film in intensifying screens at -70°C for 1-10 days or in a phosphoimager cassette for 3-48 hours.

### **3.1.6.6. Labelling reaction**

DNA for labelling was obtained by either restriction digestion or PCR amplification and purified by the isolation from the 1% LMT agarose. Reagents for the labelling reactions were obtained from the DECAprime II DNA labelling kit (Amersham). 75 ng of DNA were dissolved in 30.5 mL of water, 7.5 mL of 10x DECAmer primer was added and the mixture was denatured by boiling for 5 minutes and chilled in liquid nitrogen. 15 mL of the 5x reaction buffer –CTP, 200mCi of dCT<sup>32</sup>P and 10U of the exonuclease-free Klenow enzyme were added. The reaction was incubated at 37°C for 2 hours and stopped by 13.3mM EDTA. DNA was denatured again by boiling for 5 minutes and chilled in liquid nitrogen. Uncorporated nucleotides were removed using the ProbeQuant G-50 microcolumns (Amersham).

### **3.1.6.7. Probe stripping**

If reprobing was planned, was membrane was incubated in the boiling 0.1xSSC; 0.5% SDS for 5-10 minutes. After that the membrane was exposed for 16 hours.

### **3.1.7. Isolation and reverse transcription of RNA**

Aseptic RNAase-free technique was followed during all manipulations with RNA. This included using RNAse free disposable plasticware (Ambion), DEPC treated glassware, pre-treatment of all solutions with DEPC.

#### **3.1.7.1. RNA isolation**

RNA was isolated using the RNeasy mini kit (Qiagen) according the manufacturer's protocol. Concentration of RNA was determined by comparing the intensities of fragments fluorescence in UV with RNA standards following electrophoresis in 1% agarose gel in 1x TBE. Contaminating genomic DNA was degraded by DNase I (DNA-free, Ambion) in 1x DNase I buffer (Ambion) at 37°C for 1 hour. After that DNase I was inactivated using the DNase inactivation reagent (Ambion) according the manufacturer's protocol.

### 3.1.7.2. Reverse transcription – polymerase chain reaction (RT-PCR).

1 µg of DNA-free RNA was used as a template for the random primed reverse transcription reaction using the RETROscript first-strand synthesis kit for RT-PCR (Ambion) according to the manufacturer's protocol. 10% of the reaction final volume was used as a template for PCR. Templates were mixed with 10 pmoles of each primers, dNTPs (Roche) (final concentration of each dNTP 0.2mM), 10x PCR buffer (Qiagen) and heat at 94°C for 3 minutes. After that 0.625 U of Taq DNA polymerase (Qiagen) diluted in the 1x PCR buffer (Qiagen) was added to each PCR reaction. PCR was carried out on Biometra UNOII Thermocycler. Cycling conditions and sequences of PCR primers are tabulate below (Table 1):

Table 1. PCR conditions

Target gene	Primers	PCR conditions
AML1	Forward: 5' CCAGCAAGCTGAGGAGCGGCG 3' Reverse: 5' CCGACAAACCTGAGGTCGTTG 3'	35 cycles: 94°C 1 min, 60°C 1 min, 72°C 1 min.
rtTA	Forward: 5' AACAAACGCCAAGTCATTC 3' Reverse: 5' GCCGAAAAGGAAGGCAG 3'	40 cycles: 94°C 30 sec, 56°C 30 sec, 72°C 40 sec.
actin	Forward: 5' CCAGAGCAAGAGAGGTATC 3' Reverse: 5' TGAAGGTGGACAGTGAG 3'	30 cycles: 94°C 30 sec, 55°C 30 sec, 72°C 1 min.

PCR products were analysed on a 1% agarose gel in 1x TAE. 0.5-1 µg of 1 kb DNA ladder was loaded on each gel as a size standard.

### 3.1.8. Luciferase reporter assay

Cells on 12- or 6-well plates were lysed using 1x passive lysis buffer (Promega). Lysates were clarified by centrifugation at 16000xg for 30 seconds. Firefly and *Renilla* luciferase activities in the lysates were assayed using the Dual-Luciferase Assay System (Promega). Luminescence was measured using the Mediators Diagnostic Systems PhL machine.

### **3.2. Cell biology methods**

Routine culture of ES cells was carried out as recommended (Smith 1991). All ES cell manipulations were performed in laminar flow sterile hoods using a strict sterile technique that included wiping the hood down and spraying all items entering the hood with 70% industrial methylated spirits. Cell culture plasticware was supplied by Iwaki and Nunc. All cell culture plates were gelatinised (0.1% gelatine in PBS for 20 minutes). Undifferentiated ES cells were grown in 7.5% CO<sub>2</sub> at 37°C in a humidified incubator (Laboratory Supplies Ltd). All solutions were tested for sterility and warmed to 37°C prior to use. ES cells were examined using an inverted microscope (Olympus CK2). ES cells were maintained in 1x GMEM ES cells culture medium containing 10% fetal calf serum, 0.1% MEM non-essential amino acids, 4mM glutamine, 2mM sodium pyruvate, 0.1 mM  $\beta$ -mercaptoethanol. The medium was supplemented with recombinant human LIF (100u/mL). LIF conditioned medium was prepared by transient transfection of COS-7 cells by the LIF expression medium (Smith 1991). Plasmid DNA solution was sterilised before transfection. For that, it was precipitated using 96% ethanol, washed with 70% ethanol, air dried in a hood and dissolved in sterile PBS. All solutions for tissue culture experiments including LIF conditioned medium were prepared by the tissue culture staff.

#### **3.2.1. Thawing ES cells**

A vial with frozen ES cells was taken from the liquid nitrogen storage and thawed in a 37°C water bath. The cell suspension was transferred to a tube with 7 mL of pre-warmed ES cell medium and centrifuged immediately at 300xg for 3 minutes. The cell pellet was resuspended in ES cell medium and transferred into the gelatinised cell plate. The medium was changed next day in order to remove dead cells and traces of DMSO.

#### **3.2.2. Passaging and expansion of ES cells**

ES cells were usually passaged every two days. The cells were washed with PBS; 2-3 mL of trypsin solution was added to a 100mm Petri dish and incubated at 37°C for 3-5 minutes. The cells were pipetted until a single cell suspension was obtained. After that trypsin was neutralised with the ES cell medium and an aliquot of cells was plated onto a new gelatinised plate.

### 3.2.3. Freezing of ES cells

The cells were trypsinised, pelleted by centrifugation, resuspended into 0.9 mL of the ES cell medium and transferred to a cryovial (Nunc). 0.1 mL of DMSO was added to the cell suspension and cryovials were rapidly transferred to a -80°C freezer. 24 hours later cryovial were transferred to liquid nitrogen storage.

### 3.2.4. Transfection of ES cells

#### 3.2.4.1. Electroporation

The cells were trypsinised and counted in a hemocytometer. The appropriate number of cells was pelleted by centrifugation, resuspended in PBS, pelleted again, resuspended in 0.7 mL of PBS and transferred into an electroporation cuvette (BioRad 0.4.cm gap). DNA dissolved in 0.1 mL of PBS was added to the cuvette. Amount of cells and DNA used for different electroporation experiments are tabulated below (Table 2).

Table 2. Conditions of electroporation

Experiment	Number of cells	Amount of DNA
AML1 gene targeting	$1 \times 10^7$	40 $\mu\text{g}$
Cre-plasmid transient transfection	$1 \times 10^7$	2 $\mu\text{g}$
Single <i>loxP</i> targeting	$5 \times 10^7$	100 $\mu\text{g}$ of each plasmid

Electroporation was performed in GenePulser transfection apparatus (BioRad) at 240V, 500  $\mu\text{kF}$  usually giving a time constant of 6.2-7.8 msec. Electroporated cells were rapidly transferred to 7 mL of ES medium and plated. Drug selection was started 24-48 hours after electroporation. Cells were selected using 300-350  $\mu\text{g/mL}$  of G418 12-15 days. The drug-containing medium was changed every two days. Drug resistant colonies were picked up with a Pasteur pipette and transferred into a 24- or 48-well plate for further expansion.

### **3.2.4.2. Lipofection**

#### **3.2.4.2.1. Lipofection of the E14/T cells with episomal vectors**

$1 \times 10^6$  of E14/T cells were plated onto a well of a 6-well plate and lipofected using 3  $\mu\text{g}$  of DNA and 3 mL of the Lipofectamine 2000 reagent (Invitrogen) according to the manufacturer's protocol. Two days later the lipofected cells were replated onto 100 mm dishes at low density ( $2 \times 10^5$  and  $5 \times 10^4$  cells per plate) into the puromycin (2  $\mu\text{g}/\text{mL}$ ) containing medium with or without LIF. The puromycin-containing medium was changed every two days. On the tenth day of selection the cells were stained using the Leishman's reagent. For this purpose, the medium was aspirated, the Leishman's reagent (BDH) was added and the cells were incubated for 5 minutes at room temperature. After that the Leishman's reagent was aspirated and the cells were rinsed with water.

#### **3.2.4.2.2. Lipofection of the regulatory and B8 ES cells with AML1/luciferase responsive constructs**

$1.5 \times 10^5$  cells were plated onto a well of a 12-well plate and lipofected 16 hours later using 0.5  $\mu\text{g}$  of DNA and 3 mL of the FuGENE 6 reagent (Roche) according to the manufacturer's protocol.

### **3.2.5. Self-renewal assay**

450 Ainv15 cells or their derivatives were plated per well of a 6-well plate with the ES cell medium containing doxycycline. Concentrations of doxycycline ranged between 5  $\text{ng}/\text{mL}$  and 1000  $\mu\text{g}/\text{mL}$ . The medium was changed every two days. After 10-14 days of cultivation the cells were washed once with PBS, fixed and stained using the Alkaline Phosphatase Leukocyte kit (Sigma-Aldrich) according to the manufacturer's protocol.

### **3.2.6. Differentiation of ES cells**

#### **3.2.6.1. EB differentiation assay**

ES cells were trypsinised at room temperature till cell clumps detached from plastic. After that, the ES cell medium without LIF was added and the cells were transferred into 30 mm bacterial dishes (Sterilin). EB suspension was pipetted every day in order to prevent EBs from adhering to plastic. Routinely, the medium was

changed every 2 days. For this purpose, the EB suspension was transferred to a tube and EBs were let to sediment by gravity. After that, the medium above the supernatant was aspirated and a fresh medium was added. Similarly, EBs were collected for lysis.

### **3.2.6.2. Methylcellulose differentiation assay**

Single cell suspension was obtained from growing ES cells by trypsinisation, followed by centrifugation and further resuspension at concentration 30 cells/mkL in complete medium without LIF. 10 mkL drops were plated onto a 150-mm bacterial dish (Sterilin) using a multichannel pipette. Inverted dishes were incubated at 37°C in 5% CO<sub>2</sub> for 48 hours. A 100-mm dish with PBS was put inside each inverted dish in order to prevent evaporation of the hanging drops. EBs were collected by flushing the dishes with PBS, transferring to a tube and letting the EBs to sediment by gravity. After that, EBs were suspended in a fresh ES cell medium without LIF, transferred into 100-mm bacterial dishes and incubated at 37°C in 5% CO<sub>2</sub> for 6 days on a rotating shaker (50 rotations per minute). The medium was changed every two days and doxycycline (final concentration 1µg/mL) was added when appropriate. On the sixth day, EBs were trypsinised, cells counted and aliquoted. 100 mkL aliquots containing  $2 \times 10^4 - 5 \times 10^4$  cells were mixed with 1.5 mL of the Methocult GF M3434 medium (StemCell Technologies Inc) and plated onto 30-mm bacterial dishes (Sterilin). Plates were incubated at 37°C in 5% CO<sub>2</sub> for 10-15 days. 0.5 mL of the fresh medium was added on the sixth day of differentiation.

### **3.2.7. Flow cytometry**

#### **3.2.7.1. Preparation of cells for flow cytometry**

Single cell suspensions were obtained by trypsinisation of cells. After that, the cells were counted using a hemacytometer and resuspended at  $1 \times 10^6$  cells/mL in cold PBS/10% FCS solution. Flow cytometry analysis was performed on FACSCalibur analyser (BD Biosciences). All FACS procedures were assisted by FACS operator in ISCR, Jan Vrana.

### **3.2.7.2. Co-staining using annexin V-PE and 7-AAD**

Cells were prepared for staining as described above and stained using the Annexin V-PE apoptosis detection kit I (BD Biosciences) according to a manufacturer's protocol.

### **3.3. Animals**

All animals were housed and bred within Biomed Unit (ISCR, The University of Edinburgh) according to the provisions of the Animals (Scientific Procedures) Act (UK) 1986. Mice were housed in a stabilised environment with a 14 hours light/10 hours dark cycle and were provided with a constant supply of water and food. Routinely, litters were left with parents until 3 weeks of age when they were weaned by separating the offspring from their parents and tail tips were taken for genotyping. At 6 weeks of age mice could be used for mating.

## **Chapter 4: RESULTS**

### **Constitutive expression of individual isoforms of AML1 in ES cells**

#### **4.1. Introduction**

The aim of the project was to generate AML1 overexpressing ES cell lines. First, an attempt to generate ES cell lines constitutively overexpressing individual isoforms of AML1 was undertaken in order to (i) test putative cytotoxic effects, (ii) investigate influence of individual isoforms of AML1 on the development of hematopoietic progenitors. For this purpose, episomal vectors for expression of foreign cDNA in ES cells were used (Aubert et al. 2002). These vectors encode the polyoma virus enhancer and origin of replication (see Figure 7). The origin of replication carries the PyF101 mutation. This mutation has been shown to be favourable for the productive infection of EC cells (Fujimura et al. 1981). The PyF101 origin of replication was successfully used in episomal vectors for ES cells (Gassmann et al. 1995). An E14/T ES cell line constitutively expressing the polyoma large T antigen was used for the episomal vectors supertransfection. Large T antigen is necessary for the polyoma virus origin of replication activity. The E14/T cells showed normal self-renewal and differentiation capacities (Aubert et al. 2002). The episomal vector used contains a bi-cistronic gene expression cassette encoding a cDNA of interest. The bi-cistronic cassette is driven by a strong ubiquitous CAG promoter functional in many cell types including ES cells (Niwa et al. 1991). The first cistron encodes a cDNA of interest followed by ECMV (encephalomyocarditis virus) IRES which ensures initiation of translation in the second cistron. The second cistron encodes the puromycin resistance gene (Puro<sup>r</sup>) followed by the bovine growth hormone (BDH) polyadenylation (pA) signal. When puromycin is applied to supertransfected E14/T cells only cells harbouring the episomal vector survive. The vector also contains ColE1 origin of replication and may be amplified in *E. coli* in presence of ampicillin.

#### **4.2. Generation of episomal vectors**

Three novel episomal vectors were generated on the basis of an EGFP containing episomal vector described above which had been provided by Dr. Ian Chambers (University of Edinburgh). EGFP was cut out from the original vector by digestion using the Eco RI restriction enzyme. The 6.4 kb vector was used for (i)

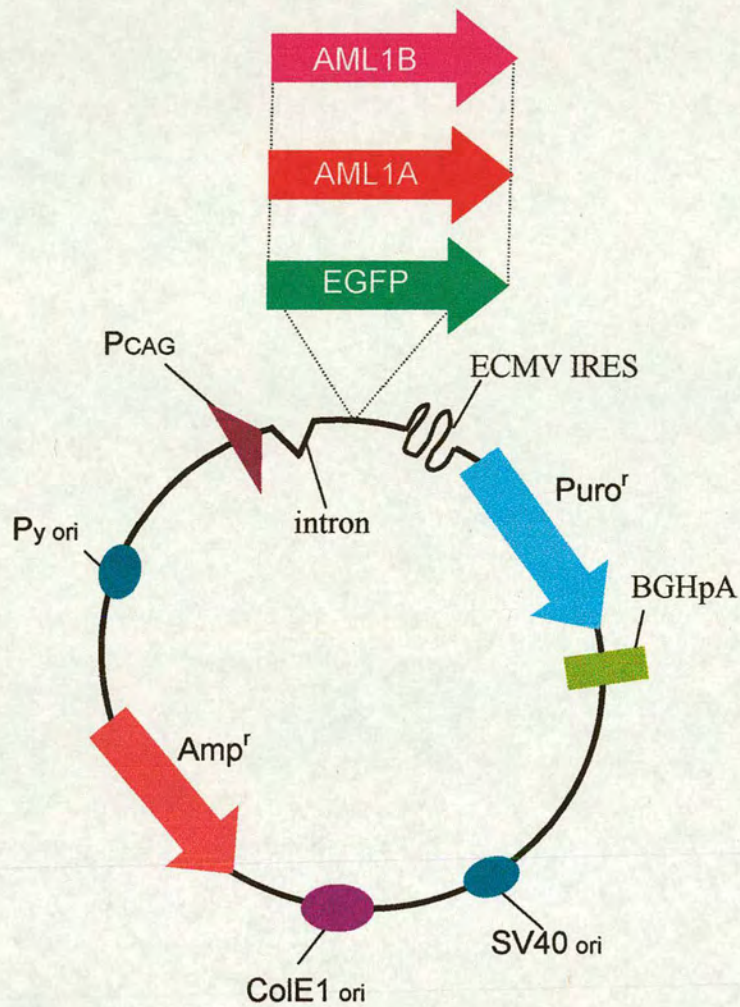

**Figure 7. Diagram of episomal vectors**

Three vectors with different inserts (EGFP, AML1A and AML1B) and a vector without any insert were used for supertransfection of E14/T cells. Py: polyoma virus. Intron: a chimeric intron consisting of the chicken  $\beta$ -actin and rabbit  $\beta$ -globin gene fragments. See text for the detailed description of other elements of the vector.

self-ligation, (ii) ligation of the AML1A and AML1B inserts. The self-ligation yielded a control vector without an insert. Plasmids with human AML1A and AML1B cDNAs were kindly provided by Dr. Issay Kitabayashi (Japan). The AML1 cDNAs were tagged with epitopes at their N-termini. The 0.8 kb HA-AML1A and 1.4 kb Flag-AML1B inserts were cut out using the *Stu* I and *Cla* I restriction enzymes. The *Cla* I 5' protruding ends of the inserts and *Eco* RI 5' protruding ends of the vector were filled-in using T4 DNA polymerase before ligation. Recombinant molecules with the head-to-tail orientation of the AML1A (or B) and Puro<sup>r</sup> genes were selected and verified by sequence.

### **4.3. Supertransfection of ES cells**

E14/T cells for supertransfection with episomal vectors were provided by Dr. Ian Chambers (ISCR, University of Edinburgh). Control vectors with and without EGFP insert and experimental vectors containing the AML1A and AML1B isoforms were supertransfected independently. These experiments were repeated three times. Two days after supertransfection, the cells were replated at low density in presence of LIF and puromycin (2 µg/mL) was added to culture medium. Cells supertransfected with the EGFP episomal vector showed green fluorescence under the microscope during the period of observation (see Figure 8). On the day 10 of culture, the cells were fixed and stained with the Leishman's reagent (see Figure 9). A large number of colonies were observed in supertransfected cells with or without EGFP insert. In contrast, the AML1A supertransfectants gave few colonies, while the AML1B supertransfectants gave no colonies at all. Similar results were obtained when the cells were cultured in the absence of LIF after supertransfection. However in this case both control and AML1A supertransfectants produced fewer colonies which underscores the important role of LIF in the ES cells propagation.

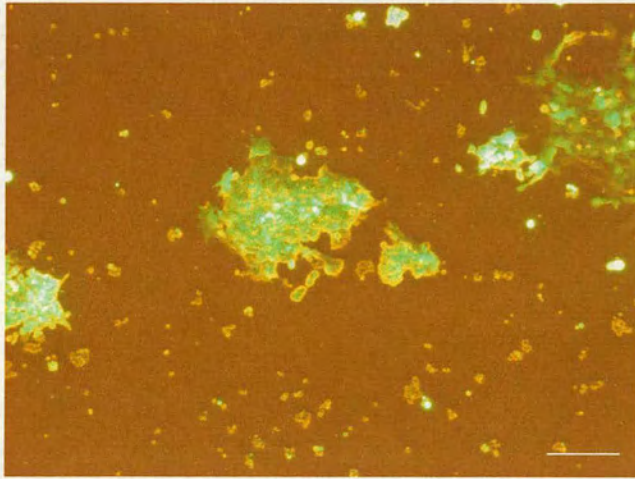

**Figure 8. EGFP expression in the E14/T supertransfected cells**

Microphotograph of the E14/T cells supertransfected with a control episomal vector with the EGFP insert on the fifth day of the puromycine selection. The scale bar represents 100  $\mu\text{m}$ .

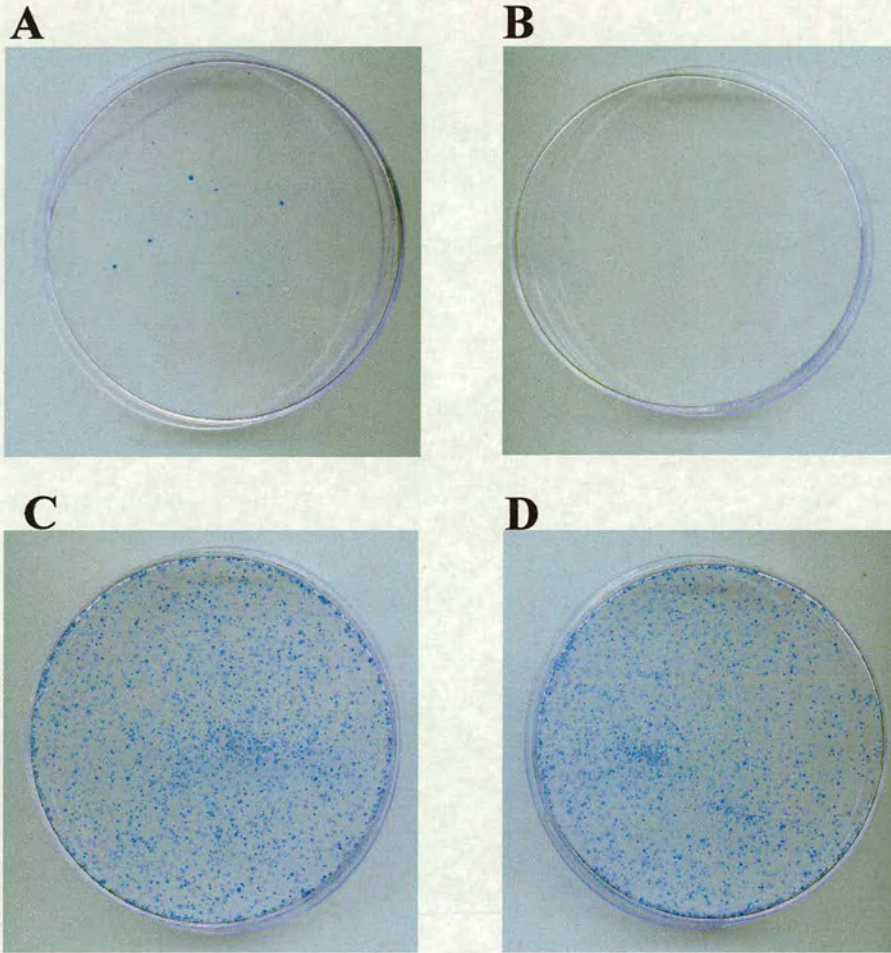

**Figure 9. The AML1 overexpression has an inhibitory influence on the ES cell growth**

Supertransfected E14/T cells were replated at low density two days after transfection and grown in the puromycin (2  $\mu\text{g}/\text{mL}$ ) containing medium in the presence of LIF for 10 days. The photographs of representative 10 days Leishman's stained cultures are shown. Four episomal vectors with different inserts or without an insert were supertransfected independently: (A) AML1A insert, (B) AML1B insert, (C) no insert and (D) EGFP insert.

## Chapter 5: RESULTS

### Generation of AML1/rtTA regulatory ES cells and mice

#### 5.1. Introduction

High levels of expression of AML1 isoforms in ES cells have cytotoxic effect, whereas low levels of AML1 expression have been reported to be tolerable by ES cells (Aziz-Aloya et al. 1998). Therefore an inducible gene expression system might be a useful alternative. A system for inducible expression of individual isoforms of AML1 was designed on the basis of the Tet-On gene expression system. A new potent tetracycline-dependent transactivator rtTA<sup>S</sup>-M2 was targeted into the AML1 locus in order to ensure its expression in hematopoietic progenitors. This should allow inducible expression of AML1 individual isoforms in hematopoietic progenitors. The level of expression is expected to be dose-dependent upon the doxycycline induction both *in vitro* and *in vivo* (see Figure 10).

#### 5.2. Generation of the regulatory construct

The regulatory construct for the AML1 gene targeting has been generated on the basis of AML1 genomic clones. rtTA gene expression cassette was inserted downstream of the AML1 proximal promoter. Generation of the regulatory construct consisted of two stages: (i) generation of the rtTA gene expression cassette and (ii) cloning of the rtTA gene expression cassette into the AML1 genomic clones.

The pUHrT62-1 plasmid encoding highly inducible, low background rtTA<sup>S</sup>-M2 regulator (further referred as rtTA) was kindly provided by Prof. Hermann Bujard (Germany). To generate the rtTA gene expression cassette a three-step cloning strategy was designed (see Figure 11). First, the 1.4 kb insert containing rtTA followed by the SV40 polyadenylation signal was excised from the pUHrT62-1 plasmid using the Eco RI and Pvu II restriction enzymes and ligated into the 3 kb pBlueScript II SK+ vector ("Stratagene") whose multiple cloning site (MCS) was digested using the Eco RI and Sma I enzymes. Since both Pvu II and Sma I enzymes generate blunt ends the insert was cloned directionally and recombinant molecules were selected. As a result of this procedure, the rtTA-SV40pA insert had been

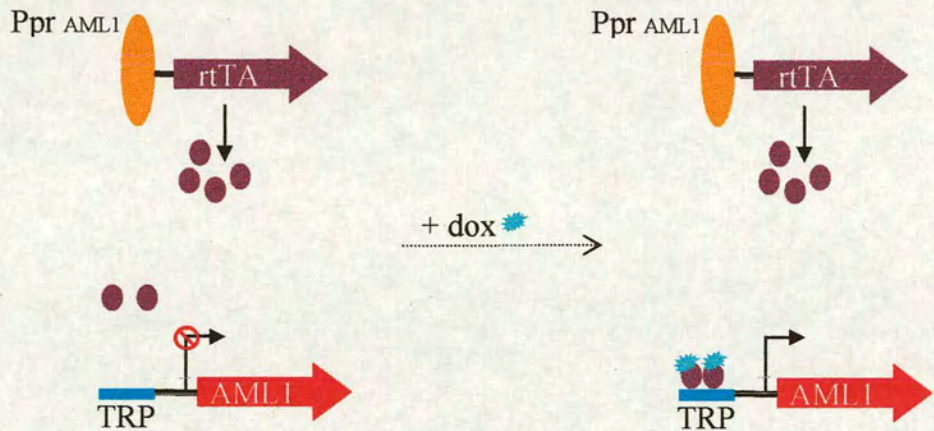

**Figure 10. Schematic representation of the Tet-On gene expression system for conditional overexpression of the AML1 individual isoforms in hematopoietic progenitors**

The rtTA transactivator (violet arrow) is targeted into the AML1 gene locus and driven by the AML1 proximal promoter (orange oval). cDNA of an individual isoform of AML1 (red arrow) downstream of the tetracycline responsive promoter (TRP, cyan rectangle) is integrated into the genome of the same cell. There is no AML1 cDNA expression in the absence of doxycycline. Upon the doxycycline (cyan star) addition, rtTA interacts with TRP and upregulates the AML1 cDNA.

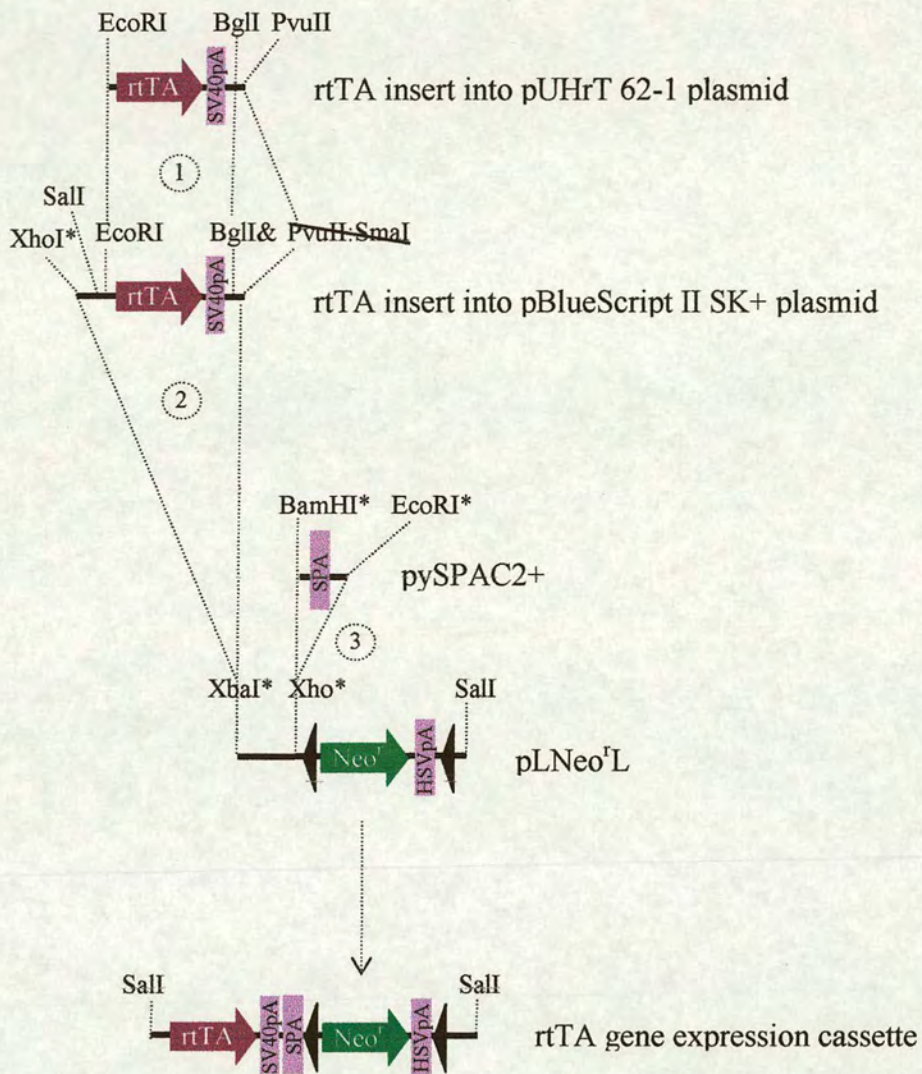

**Figure 11. Diagram of the three step cloning of the rtTA gene expression cassette**

- 1 – Cloning of rtTA into the pBlueScript II SK + vector.
- 2 – Cloning of rtTA into the pLNeo<sup>rL</sup> vector.
- 3 – Cloning of SPA into the pLNeo<sup>rL</sup>-rtTA vector.

LoxP sites are shown as black triangles. Restriction sites marked with asterisks had generated 5' overhangs which were filled-in after digestion. The Bgl I restriction enzyme generated the 3' overhangs which were removed (marked with an ampersand). Ligation of the Pvu II digested rtTA-SV40pA into the Sma I digested vector generated no restriction site at the insert-vector junction (crossed out).

flanked by new cloning sites which were used during subsequent cloning steps. Second, the 1.1 kb rTA-SV40pA insert was excised from the pBluescript vector using the XhoI and Bgl I restriction enzymes. The insert was smaller than the initial one, because almost 0.2 kb of the vector sequence located between the Bgl I and Pvu II restriction sites had been left in the plasmid. The 5' protruding Xho I ends were filled-in whereas 3' protruding Bgl I ends were removed using the T4 DNA polymerase. The insert was cloned into the linearised 5.2 kb pLNeo<sup>r</sup>L plasmid vector (kindly provided by Dr. Igor Samokhvalov, The University of Edinburgh). The pLNeo<sup>r</sup>L plasmid encodes a floxed selection cassette consisting of a neomycin resistance gene (Neo<sup>r</sup>) followed by the HSV polyadenylation signal. The vector was digested upstream the 5' *loxP* site using the Xba I restriction enzyme. The Xba I 5' protruding ends were filled-in using the T4 DNA polymerase. Recombinant molecules with the head-to-tail orientation of the rTA and Neo<sup>r</sup> genes were selected. Third, the combined transcriptional termination sequence SPA-C2MAZ was inserted between the SV40 polyadenylation signal and 5' *loxP* site. The SPA-C2MAZ termination sequence consists of a synthetic polyadenylation signal (SPA) and the complement gene C2 MAZ binding site. SPA is a highly efficient polyadenylation sequence based of the rabbit  $\beta$ -globin gene regulatory elements (Levitt et al. 1989). MAZ (Myc-associated zinc finger) is a zinc finger protein interacting with DNA and presumably promoting its bending. It is supposed that bent DNA acts as a transcriptional terminator (Ashfield et al. 1994). Thus, the SPA-C2MAZ sequence (further referred as SPA) is a potent terminator of transcription. Its insertion into the rTA gene expression cassette promotes transcriptional termination downstream of rTA. The SPA containing plasmid pySPAC2+ was kindly provided by Prof. Nicolas Proudfoot (University of Oxford). The 0.2 kb SPA insert was excised using the Bam HI and Eco RI enzymes. The Bam HI and Eco RI 5' protruding ends were filled-in using T4 DNA polymerase. The insert was cloned into the 6.3 kb pLNeo<sup>r</sup>L-rTA vector linearised between the SV40 polyadenylation signal and 5' *loxP* site using the Xho I enzyme. The Xho I 5' protruding ends were filled-in using T4 DNA polymerase. Recombinant molecules with the sense orientation of the termination sequences were selected. Taken together, the rTA gene expression cassette generated during a three step cloning procedure consists of rTA followed by the SV40 and SPA polyadenylation signals and the floxed Neo<sup>r</sup> gene. The cassette may be released from the vector by the Sal I digest. Of note, the 5' Sal I site is coming from the pBlueScript vector MCS and has been brought by the rTA-SV40pA insert while the 3' Sal I site belongs to the pLNeo<sup>r</sup>L plasmid initially.

During the second stage of generation of the regulatory construct, the rtTA gene expression cassette was encompassed by the AML1 genomic DNA providing homology arms necessary for gene targeting. The AML1 genomic DNA was isolated from a lambda phage genomic library and subcloned by Dr. Igor Samokhvalov in the laboratory (see Figure 12). The isolated genomic DNA had length of 13 kb and covered a region upstream exon 3, exons 3 and 4, an intron between the exons, and a part of an intron downstream the exon 4. Lambda genomic DNA was digested and subcloned into the pBlueScript II SK+ plasmid vector; namely, (i) the 3 kb fragment containing exon 3 and flanking intron regions was excised using the Xba I enzyme, (ii) the 11 kb fragment containing the major part of exon 3, exon 4 and introns between these exons and downstream the exon 4 was excised using the Xho I enzyme and (iii) the most 5' promoter/intron 1kb DNA fragment was amplified by PCR.

Since I aimed to express rtTA in AML1 positive cells it looked attractive to target rtTA into exon 3 which is the first coding exon of proximal transcripts. The initiator ATG codon of exon 3 resides within the Bsa BI restriction enzyme recognition site which is GATGCGTATC (the initiator codon is underlined) (see Figure 13). Of note, the Bsa BI enzyme recognises a discontinuous site GATNNNNATC and cuts it between the fifth and sixth nucleotides (fourth and fifth coding nucleotides of AML1) generating blunt ends. At the same time, rtTA DNA has a unique Xba I restriction site just downstream its initiator ATG codon. A blunt-ended fragment with the 5' rtTA fifth coding nucleotide is generated, if rtTA is digested using Xba I and 5' protruding ends are filled-in using T4 DNA polymerase. Taken together, if AML1 genomic DNA is digested using the Bsa BI enzyme and the fourth coding nucleotide of the AML1 genomic fragment is ligated with the fifth coding nucleotide of the rtTA fragment, rtTA will be cloned in-frame with the AML1 first coding ATG. However, the rtTA fourth coding nucleotide will be different in the new and initial molecules, namely C will be in a new molecule, while T is in the initial one. Since this causes a substitution of the rtTA second amino acid, C was mutated to T in the AML1 genomic DNA before cloning in order to avoid any possible complications. Of note, this mutation does not influence the Bsa BI digestion, because it resides in the variable part of the restriction site.

The generation of the regulatory construct consisted of four steps (see Figure 14). First, the fourth coding nucleotide C was substituted with T by site-directed mutagenesis of the pXba3 plasmid. Mutants were selected and verified by sequence.

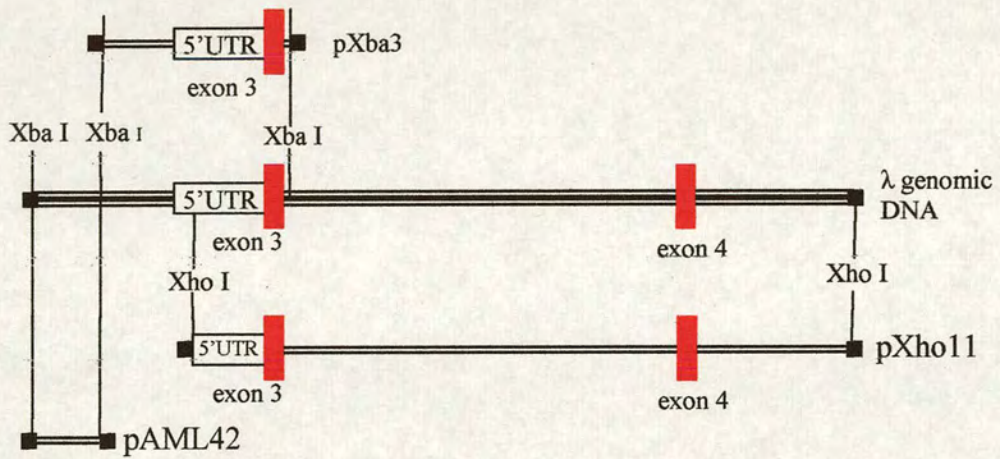

**Figure 12. Diagram of the AML1 genomic clones**

**(kindly provided by Dr. Igor Samokhvalov)**

The AML1 genomic DNA (triple line) was digested and subcloned into the pBluescript vector generating new pXba3 and pXho11 plasmids (double lines). The insert cloned into the pAML42 plasmid was amplified by PCR. Vector DNA is delineated by solid line.

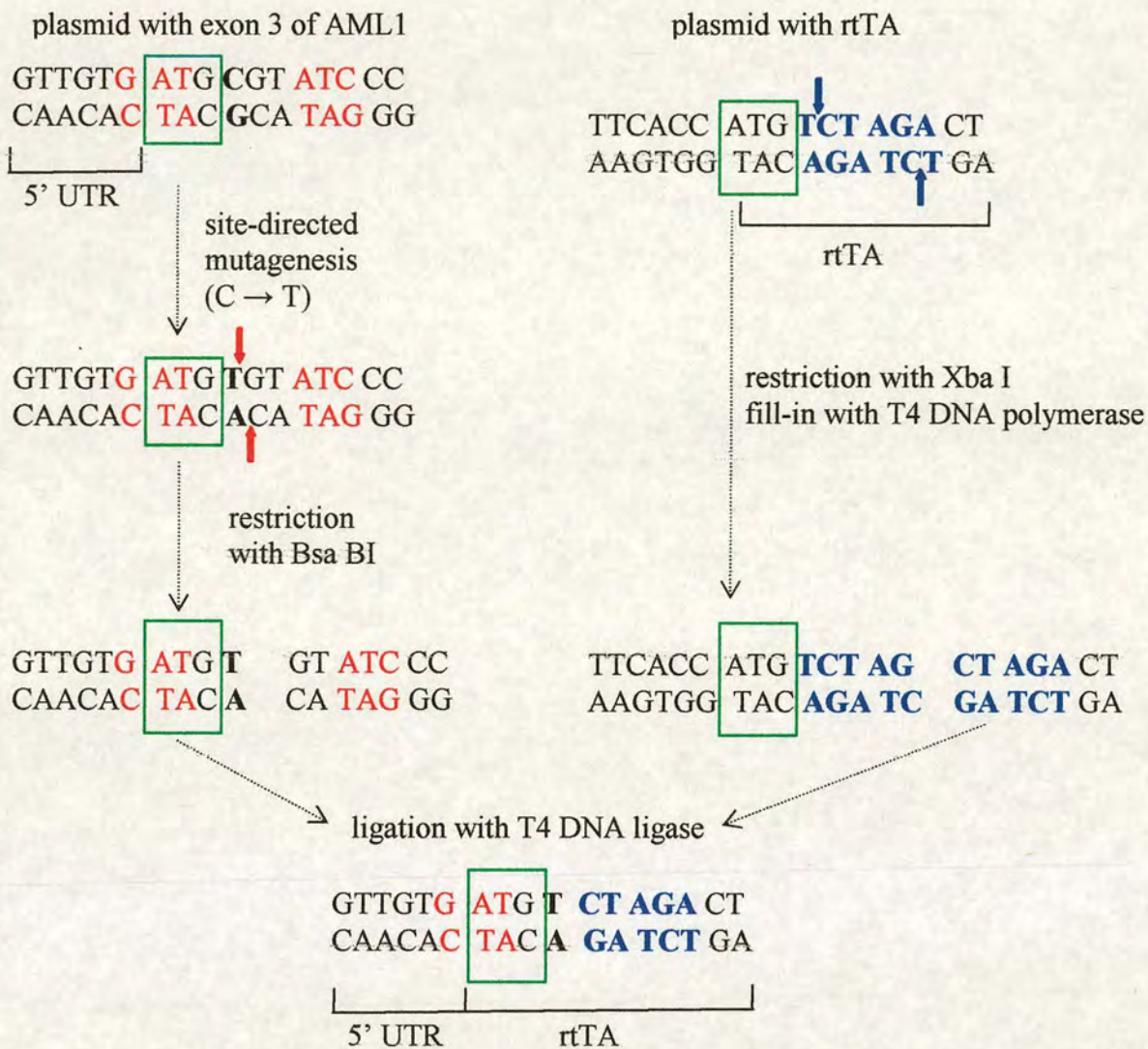

**Figure 13. Schematic representation of the rtTA gene expression cassette cloning into the AML1 genomic DNA containing plasmid**

The Bsa BI restriction enzyme binds to the GATNNNNATC site and cuts it between fifth and sixth nucleotides. The fifth nucleotide C was substituted for T in the AML1 containing plasmid by site-directed mutagenesis, thus restoring the correct rtTA sequence upon ligation. The rtTA containing plasmid was digested using the Xba I restriction enzyme and the 5' protruding ends were filled-in using the T4 DNA polymerase. The non-variable nucleotides of the Bsa BI recognition site are in red. The Xba I recognition site is in blue. The AML1 first coding ATG is designated by a green rectangle. Nucleotides that have undergone site-directed mutagenesis are in bold.

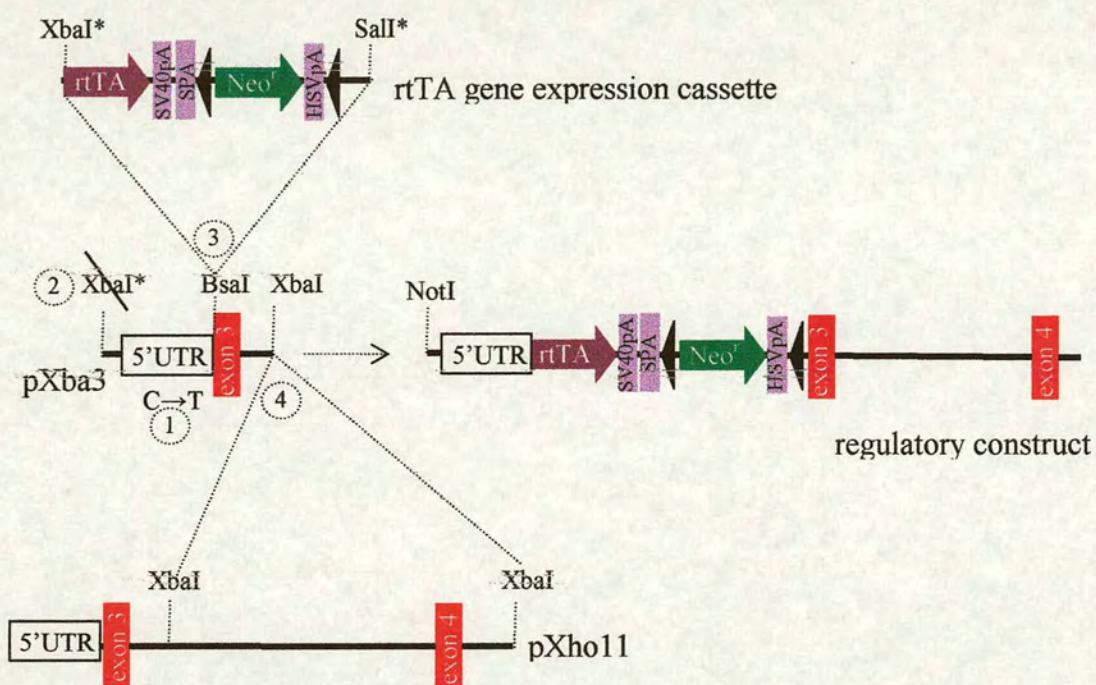

**Figure 14. Diagram of the four step cloning of the regulatory construct**

1. Site-directed mutagenesis of the pXba3 plasmid.
  2. Destroying of the Xba I site (crossed out) by restriction digestion and 5' overhang fill-in.
  3. Cloning of the rtTA gene expression cassette.
  4. Cloning of the AML1 genomic DNA fragment.
- LoxP sites are shown as black triangles. Restriction sites marked with asterisks had generated 5' overhangs which were filled-in after digestion. Not I is a unique restriction site which has been used for the construct linearization.

Second, an Xba I site of the mutant pXba3 plasmid was destroyed by consecutive linearisation using the Xba I enzyme, fill-in of 5' protruding ends using T4 DNA polymerase and self-ligation. Self-ligated molecules with the Xba I site destroyed at the 5' end of the insert were selected. The aim of the procedure was to reduce the number of the Xba I sites in the molecule. An extra Xba I site was brought by the rtTA gene expression cassette and three Xba I sites would be in the pXba3-rtTA plasmid unless one of them had been destroyed during previous steps. Since it had been planned to use the Xba I site at the 3' end of the insert in a subsequent cloning, the Xba I site at the 5' end of the insert was destroyed. Third, the 2.5 kb rtTA gene expression cassette was excised from a vector using the Xba I and Sal I digest; 5' protruding ends were filled-in using the T4 DNA polymerase and the cassette was ligated into the pXba3 vector undergone two rounds of modifications as discussed above. The 6 kb pXba3 vector was digested using the Bsa BI restriction enzyme. Recombinant molecules with the same orientation of the rtTA and AML1 genes were selected. Fourth, the 9 kb Xba I fragment encoding the major part of an intron between exons 3 and 4, exon 4 and a part of an intron downstream exon 4 was excised from the pXho11 plasmid. This fragment was ligated into the linearised 8.5 kb pXba3-rtTA vector. The vector encodes two Xba I sites: the first one is in rtTA and the second one is at the 3' end of the insert, therefore 4 variants of recombinant molecules were expected (two possible orientations upon ligation into each restriction site). Recombinant molecules with the direct orientation of the 9 kb fragment cloned into the Xba I site at the 3' of the insert were selected. These molecules are regulatory constructs for the AML1 gene targeting. They contain AML1 genomic DNA including exons 3, 4, surrounding introns and the rtTA gene expression cassette which is cloned in-frame with the AML1 first coding ATG. The length of homology arms is 12 kb. All functional regions of the construct (exons, gene expression cassette, flanking sequences) were verified by sequence.

### **5.3. Targeting of the AML1 gene locus**

The regulatory construct was linearised using the Not I enzyme which digested a unique site locating upstream the 5' end of the insert. E14 ES cells were electroporated with the linearised construct. G418 (final concentration 0.3 mg/mL) was added to the cells 48 hours after electroporation. G418 resistant clones were selected, expanded and screened by Southern blot hybridisation for a correctly targeted allele (see Figure 15). Afl II digested genomic DNA was hybridised to a probe external to the regulatory construct. The external probe is a 112 bp fragment

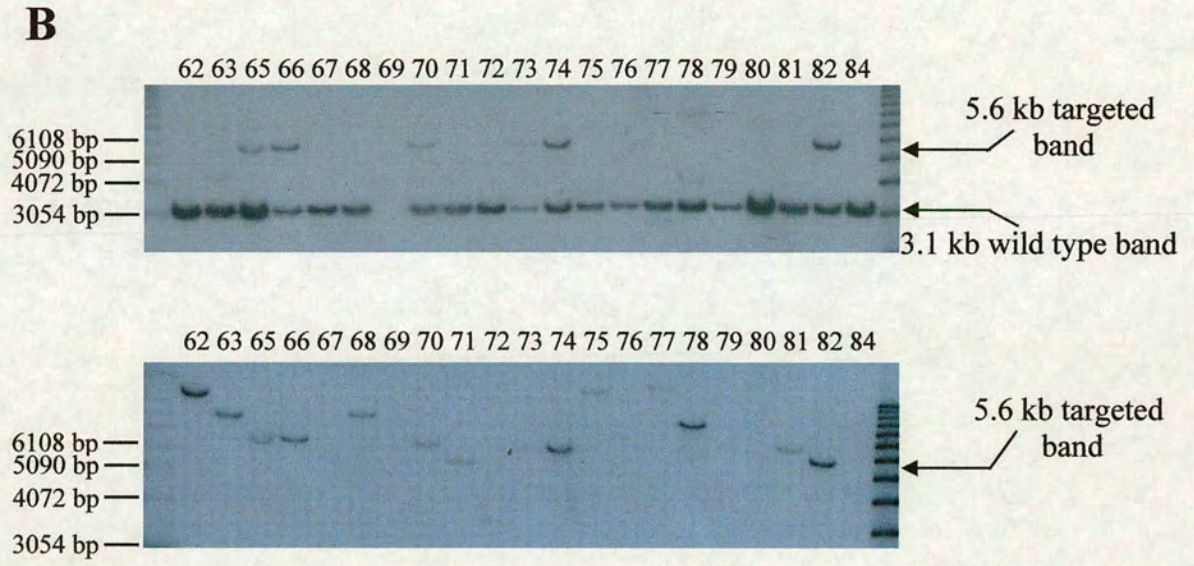
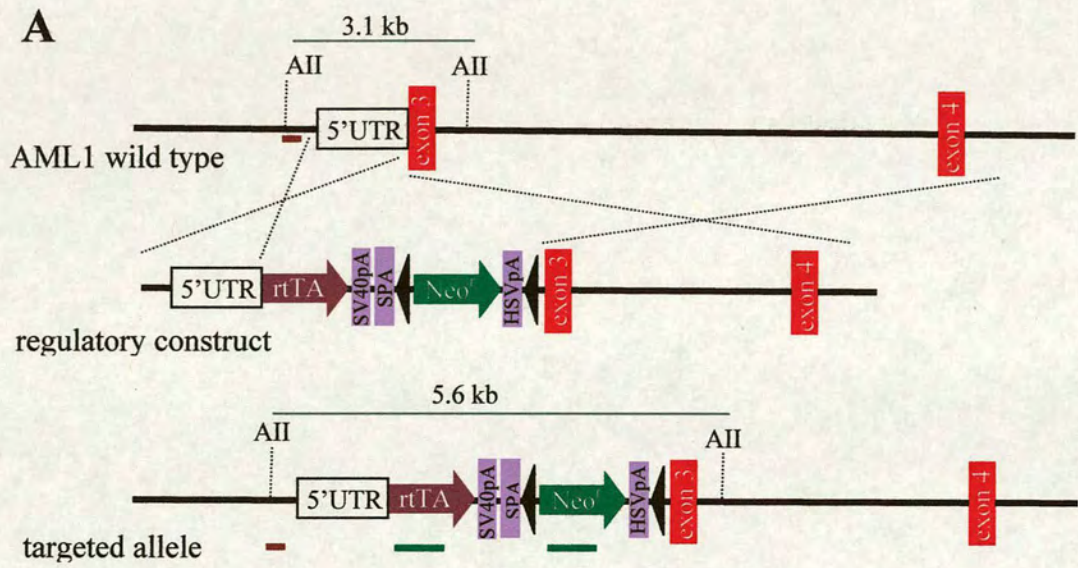

**Figure 15. Targeting of the AML1 gene locus**

**A.** Scheme of the AML1 gene targeting. Wild type AML1 allele is shown top, the targeting vector is shown middle and the targeted allele is shown bottom. *LoxP* sites are shown as black triangles. AII is the Afl II restriction site. External probe is shown as a dark red line. Internal probes are shown as green lines. Restriction fragments that hybridise to probes are shown as thin grey lines.

**B.** Representative autoradiograph showing results of the Southern blot hybridisation. Afl II digested DNA was consecutively hybridised with external (top) and internal (bottom) probes. Correctly targeted clones 66, 74 and 82 gave 5.6 kb targeted band and 3.1 wild type band with the external probe and 5.6 kb band only with the internal probe.

located upstream the 5' end of the regulatory construct. For the external probe preparation the 1122 bp insert into the pAML42 plasmid (see Figure 12) was amplified by PCR. The PCR product was digested using the Afl II restriction enzyme. The 112 bp restriction fragment was isolated and used as an external hybridization probe. The wild type allele gave a band of 3.1 kb while a correctly targeted allele gave a band of 5.6 kb. In order to select clones containing only one copy of the regulatory construct, the blots were stripped off and re-hybridised to an internal probe (the mixture of the rtTA and Neo<sup>r</sup> DNA fragments). The 1.1 kb rtTA-SV40pA cloning insert was used as an internal hybridisation probe while the Neo<sup>r</sup> fragment was obtained by PCR. The internal probe hybridised to either the targeted allele of 5.6 kb in correctly targeted clones or randomly integrated construct (any size band) in other clones. In total, 14 out of 80 screened clones contained the targeted allele.

#### **5.4. Cre-mediated excision of the selection cassette**

Neo<sup>r</sup> selection cassette may change the pattern of expression of genes of interest. For instance, silencing of an adjacent transgene has been previously described (Shin et al. 1999). Therefore, the Neo<sup>r</sup> selection cassette was excised by Cre-mediated recombination. The targeted clone 82 was transiently transfected with the pIC-Cre plasmid (kindly provided by Dr. Igor Samokhvalov, University of Edinburgh). This plasmid encodes Cre driven by the HSV TK promoter and polyoma enhancer. 48 hours after transfection the cells were replated at low density. 12 days later, 48 individually colonies were picked up and each colony was split onto two wells of a 48-well plate. Medium with 0.3 mg/mL of G418 was added to one of these wells. 11 clones which had shown the G418 sensitive phenotype after 5 days of growth were expanded and genotyped by Southern blot hybridization (see Figure 16). Afl II digested DNA was hybridised to the external probe. The wild type allele gave a band of 3.1 kb while the targeted allele gave a band of 5.6 kb and the recombined allele gave a band of 4.4 kb. 10 out of 11 clones contained the recombined allele. The eleventh clone (clone 47) did not produce any signal.

The targeting efficiency of the regulatory construct was high: 17.5% of clones were correctly targeted. Cre-mediated excision of the floxed Neo<sup>r</sup> selection cassette was also very efficient: 23% of clones lost the cassette upon transfection with the Cre-expressing cassette. Similar high efficiency of targeting of the AML locus was obtained independently by others using different constructs and slightly

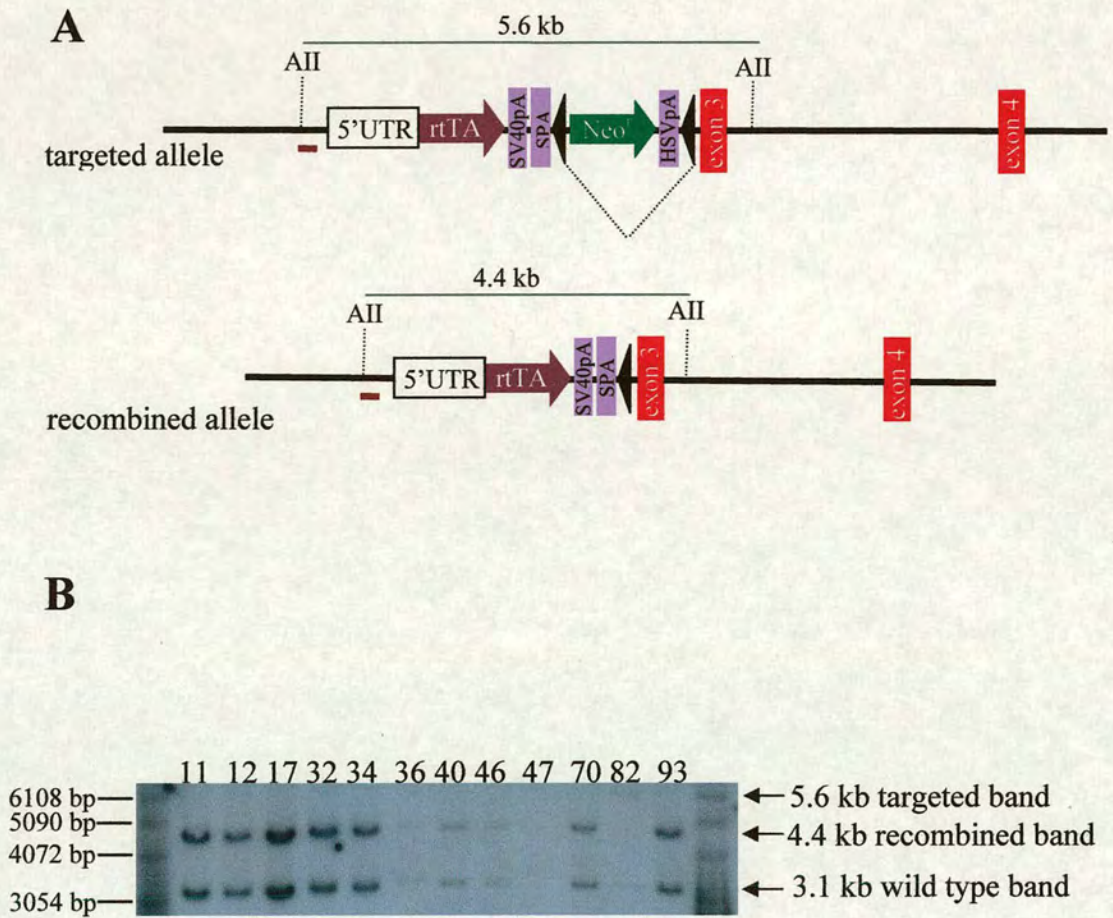

**Figure 16. Cre-mediated recombination in the AML1 gene locus**

**A.** The targeted AML1 allele is shown top and the recombined allele is shown bottom. *LoxP* sites are shown as black triangles. AII is the Afl II restriction site. Hybridisation (external) probe is shown as a dark red line. Restriction fragments that hybridise to the probe are shown as thin grey lines.

**B.** Southern blot hybridization analysis of G418 sensitive clones. Afl II digested DNA was hybridised to the internal probe. Recombined clones gave bands of 3.1 kb (wild type) and 4.4 kb (recombined). The parental clone 82 gave bands of 3.1 kb (wild type) and 5.6 kb (targeted).

different site of integration within the AML1 locus. It will be interesting to establish if the structure of the AML1 gene locus favourable for artificial recombination observed in targeting experiments is relevant to high frequency of AML1 rearrangements in human leukaemia.

### **5.5. Generation of AML1/rtTA regulatory mice**

In order to generate regulatory mice the targeted clone 14 and recombined clones 11 and 12 were injected into wild type mouse blastocysts by Janice Ure (University of Edinburgh). Male chimaeras obtained from clones 14 and 12 showed high levels of chimaerism and were test crossed to wild type mice. The chimaeras were fertile and transmitted their transgenes down the germline. Offspring from the test crossing were genotyped by Southern blot hybridisation (see Figures 17A and 17B). 3 out of 6 (clone 14) and 4 out of 7 (clone 12) genotyped animals bore the rtTA transgene.

Regulatory mice coming from the targeted clone 14 contained the floxed Neo<sup>r</sup> gene. In order to excise the floxed cassette the Zp3-Cre mice which express a Cre transgene in oocytes were used (Lewandoski et al., 1997). Two males containing targeted AML1 locus were crossed with Zp3-Cre females. The Cre-mediated excision of a floxed fragments occurred with 100% efficiency. Recombination occurred in 7 out of 12 genotyped offspring from the intercross while animals with the unrecombined transgene were not found (see Figure 17C).

During 2 years of observation regulatory heterozygous mice have been phenotypically normal, healthy and fertile. As others researchers have observed, no obvious difference between wild type and heterozygous littermates have been noticed (Okuda et al. 1996).

### **5.6. Analysis of the rtTA transgene expression in *in vitro* differentiation assay**

After that the rtTA and AML1 expression profiles in ES cells differentiating *in vitro* were compared. ES cells cultured in bacterial (low adhesive) plates in absence of LIF form compact aggregates of differentiating cells called embryoid bodies (EBs) (Doetschman et al. 1985, see chapter 1.4.4). AML1/rtTA regulatory ES cells (clone 12) were cultured in these conditions and aliquots of EBs suspension were taken every 24 hours from the day 2 till 7 of differentiation. RNA was isolated

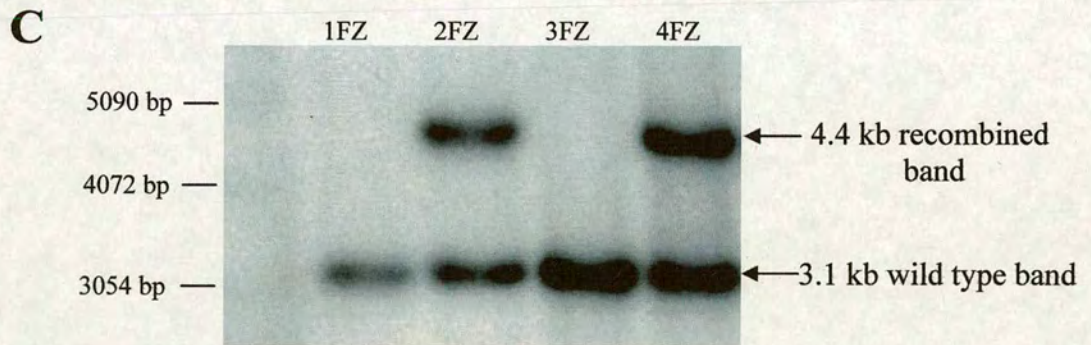
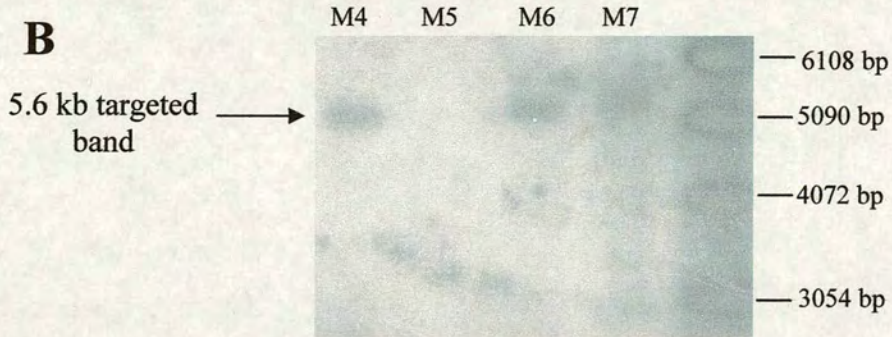
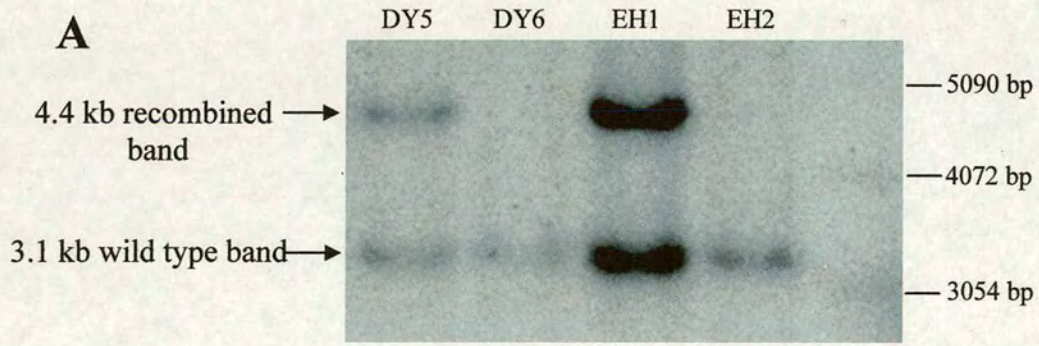

**Figure 17. Genotyping of the AML1/rtTA regulatory mice**

**A, B.** Chimaeras obtained by blastocyst injections with recombined clone 12 (**A**) or targeted clone 14 (**B**) were test crossed to wild type mice. Genomic DNA from offspring was digested using the Afl II enzyme and hybridised to either the external probe (**A**) (see Legend for Figure 15) or rtTA (**B**). The targeted allele gave a band of 5.6 kb, the recombined allele gave band of 4.4 kb and the wild type allele gave band of 3.1 kb.

**C.** rtTA-bearing males coming from the targeted clone 14 were crossed to Zp3-Cre females. Genomic DNA was digested using the Afl II restriction enzyme and hybridised to the external probe for genotyping.

from EBs. Contaminating genomic DNA was removed by the DNase I treatment and RNA was used for the AML1 and rtTA-specific RT-PCR. RT-PCR for a house-keeping  $\beta$ -actin gene was set up as an internal control. Both, AML1 and  $\beta$ -actin specific primers were complementary to sequences in neighbouring exons. Therefore, amplification of genomic DNA across intron boundaries was largely prevented and in any case would yield a product of a different size than from RNA. In contrast, the entire rtTA transgene is located within the same exon and therefore products of RNA and DNA amplifications would be indistinguishable. In order to monitor the levels of the genomic DNA contamination control PCR reactions using the rtTA gene specific primers were set up. The reverse transcriptase enzyme was not added to the appropriate reaction mixture (mock reverse transcription), therefore contaminating genomic DNA could only be amplified during PCR using the mock reverse transcription reaction “products”.

All samples used for RT-PCR contained similar amount of RNA since amplification using the  $\beta$ -actin gene specific primers demonstrated equivalent amounts of the product (see Figure 18). No bands were amplified using the mock reverse transcribed templates and rtTA specific primers. Therefore, no contamination with genomic DNA was found. It has been found that both rtTA and AML1 genes demonstrated similar kinetics of expression during EB differentiation. Low levels of expression were observed between days 2 and 4 of culture that followed by a gradual increase thereafter. Highest levels of expression of AML1 and rtTA were observed on days 6 and 7 of differentiation. Similar results were reported by other researchers: low level of expression of AML1 was observed during the first days of ES cell *in vitro* differentiation, followed by significant increase in expression between days 4 and 8 (Fujita et al. 2001; Lacaud et al. 2002).

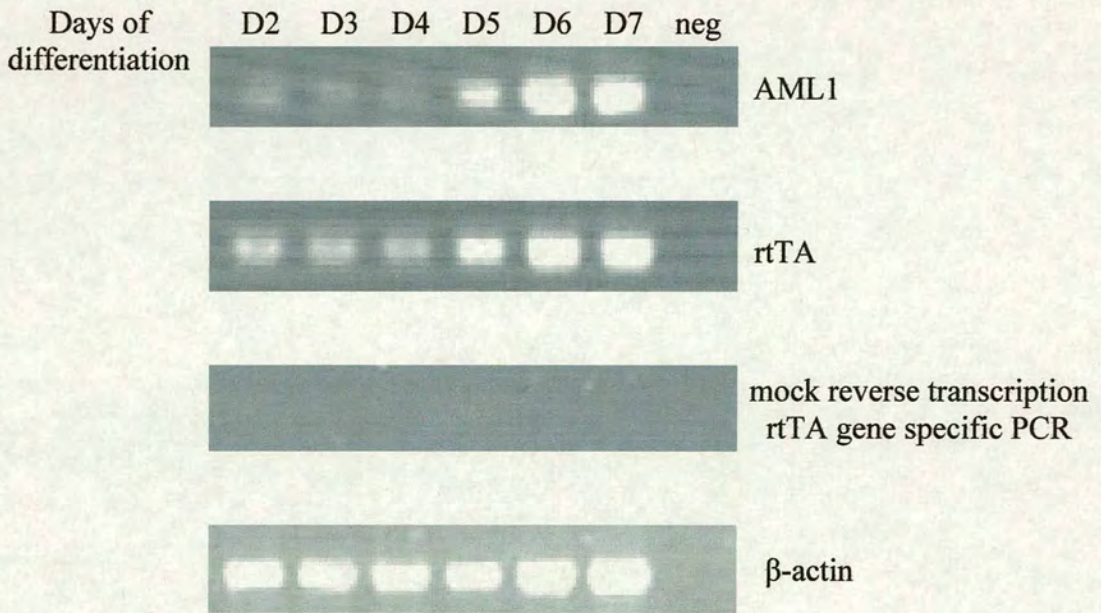

**Figure 18. Kinetics of rtTA and AML1 expression during ES cells *in vitro* differentiation.**

AML1, rtTA and  $\beta$ -actin expression was detected by RT-PCR upon isolation of RNA from *in vitro* differentiating ES cells. Mock reverse transcribed templates were amplified using the rtTA gene specific primers as the genomic DNA contamination control. Neg designates no template control.

## **Chapter 6: RESULTS**

### **Generation of responsive ES cells and mice**

#### **6.1. Introduction.**

In the previous part of my research AML1/rtTA regulatory ES cells and mice were generated. A further step included generation of responsive components of the system. Initial experiments showed that the rtTA expression follows AML1 expression kinetics and can be detected during first days of ES cells differentiation. Therefore, one can expect the induction of a reporter gene in cultures of undifferentiated AML1/rtTA regulatory ES cells. Therefore, the regulatory ES cells were transiently transfected with responsive constructs in order to (i) test functionality of rtTA and (ii) optimize experimental conditions for efficient induction of a reporter gene by doxycycline.

#### **6.2. Generation of responsive ES cell lines**

##### **6.2.1. Generation of the luciferase responsive constructs**

Luciferase responsive constructs were generated on the basis of a bi-directional tetracycline responsive vector (Baron et al. 1995) (see Figure 18). The vector encodes bTRP driving simultaneous transcription of two genes in opposite directions. Therefore, vectors with bTRP driving expression of both an individual AML1 isoform and the firefly luciferase reporter gene were generated. Firefly luciferase is a widespread genetic reporter catalyzing oxidation of the luciferin substrate in the presence of ATP, oxygen and magnesium cations. The reaction results in light emission. Since the intensity of light is proportional to the luciferase concentration, the intensity of the luminescent signal produced by a cell lysate is determined by levels of the luciferase expression. Modern methods of the firefly luciferase activity measurement allow detecting as little as a femtogram of the protein and extend over a range of eight orders of magnitude of its concentration (Sherf et al. 1996).

The pBI-L tetracycline bi-directional vector (“Clontech”) was used for the generation of the luciferase responsive constructs. The vector encodes bTRP flanked by MCS and the luciferase expression unit. MCS is suitable for the cloning of a gene of interest and therefore is followed by the rabbit  $\beta$ -globin polyadenylation signal.

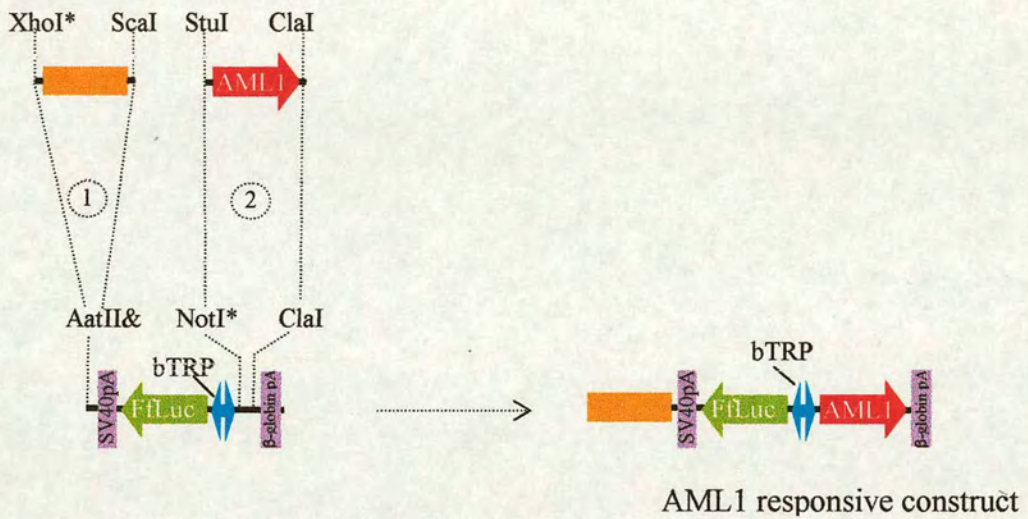

**Figure 19. Diagram of the two step cloning of the luciferase responsive constructs for transient transfection assays**

1. Cloning of exogenous DNA into the pBI-L vector.
2. Cloning of the AML1 cDNA into the pBI-Le vector.

Two responsive constructs with different isoforms of AML1 (A and B) were generated. Restriction sites marked with asterisks had generated 5' overhangs which were filled-in after digestion. A restriction site marked with an ampersand generated the 3' overhangs which were removed. Exogenous DNA is shown by the orange rectangle.

The luciferase expression unit consists of the firefly luciferase reporter gene followed by the SV40 polyadenylation signal. The cloning procedure consisted of two steps (see Figure 18). First, the exogenous DNA fragment was cloned into the linearised vector. The 2.8 kb fragment was excised from the human cDNA clone IMAGE: 590643 using the Sca I and Xho I restriction enzymes. The protruding 5' ends generated by the Xho I enzyme were filled-in using the T4 DNA polymerase. The insert was ligated into the 6.1 kb pBI-L vector which had been linearised downstream the SV40 polyadenylation signal using the Aat II restriction enzyme. The protruding 3' ends generated by the Aat II enzyme were removed using the T4 DNA polymerase. The recombinant plasmid called pBI-Le carried a piece of exogenous DNA cloned downstream the firefly luciferase expression unit. The aim of this cloning was to generate a homology arm which had been planned to be used in the stable transfection experiments. However, later on the experimental strategy had been changed and the construct had never been transfected stably (see below). Secondly, the AML1A and AML1B cDNAs were excised from the pLNSX vector using the Stu I and Cla I restriction enzymes what released the 0.8 kb AML1A and 1.4 kb AML1B inserts (see Chapter 4.2 for the AML1 cDNAs description). The inserts were ligated into the 9 kb pBI-Le vector subsequently treated with the Not I, T4 DNA polymerase and Cla I enzymes. The Not I enzyme digested the vector within MCS. T4 DNA polymerase filled-in protruding 5' ends of the vector generating blunt ends. The Cla I enzyme digested MCS just upstream the  $\beta$ -globin polyadenylation signal. Accordingly, the linear vector carrying the blunt and 5' protruding Cla I compatible ends was generated and used for the directional cloning of the AML1 inserts. Recombinant molecules were selected, and correct sequence of all functional regions of the AML1A/luciferase and AML1B/luciferase responsive the constructs was confirmed.

### **6.2.2. Transfection of AML1/rtTA regulatory ES cells with luciferase responsive constructs**

The AML1/rtTA regulatory and control wild type ES cells were transiently co-transfected with circular forms of the AML1B luciferase responsive construct and control pRL-TK plasmid ("Promega"). The pRL-TK non-regulatable control plasmid encodes the *Renilla* luciferase driven by the HSV TK promoter while the responsive construct carries the firefly luciferase driven by bTRP. The *Renilla* and firefly luciferases have different structures and catalyse oxidation of different substrates (reviewed by Bronstein et al. 1994). Accordingly, their activities in the same cell

lysate may be measured independently by dual-luciferase reporter assay which allows subsequent normalisation of the inducible firefly luciferase activity to the control *Renilla* luciferase. The normalisation eliminates variability between samples related to different transfection efficiency and ensures more accurate interpretation of data. The control pRL-TK plasmid constituted 10% of total transfected DNA, whereas the rest consisted either entirely of the AML1B luciferase responsive construct or this construct diluted with an unspecific DNA (the pBlueScript plasmid). Dilution of the construct is required since large amount of responsive DNA transfected into cells may result in high background activity (Freundlieb et al. 1999). AML1/rtTA regulatory ES cells and control wild type cells were plated into 12-well plates. Each variant was plated in duplicates and transfected with mixtures of the control pRL-TK and AML1B luciferase responsive plasmids. Mixtures containing 10% and 90% of the AML1B luciferase responsive construct were tested. The control mock transfection was set up in parallel. Each transfection experiment was repeated three times. To achieve higher AML1/rtTA expression transfected cells were grown in absence of LIF to increase proportion of AML1 expressing cells. Doxycycline (final concentration 1  $\mu\text{g}/\text{mL}$ ) was added to appropriate wells 16 hours after transfection. The cells were lysed 72 hours after transfection and both *Renilla* and firefly luciferase activities were quantified by the dual-luciferase reporter assay (see Figure 20). High levels of the *Renilla* luciferase expression were detected in lysates of cells transfected with luciferase containing constructs. In contrast, only background levels of both luciferases activities were determined in mock-transfected cell lysates. Thus, the cells were transfected successfully. However, induction with doxycycline did not show any significant increase in firefly luciferase expression above background. On occasions no more than 2 fold reporter induction was found.

Thus, doxycycline failed to induce the luciferase reporter in the AML1/rtTA regulatory ES cells. This failure might be caused by the low levels of AML1/rtTA expression in undifferentiated ES cells. Therefore an attempt to increase the number of AML1/rtTA expressing cells in order to enhance AML1-dependent expression of rtTA was undertaken. For this purpose, the experiment described above was repeated in a modified form. Regulatory ES cells and control wild type cells were plated into 12-well plates. The cells were co-transfected with either the AML1B responsive plasmid or the pBI-Le responsive intermediate construct and the pRL-TK control plasmid (see Figures 19 and 21). The principle of DNA composition in transfection mixture was the same as in previous experiments (see the paragraph above). Transfecting DNA consisted of the pRL-TK control plasmid (10% of the total DNA

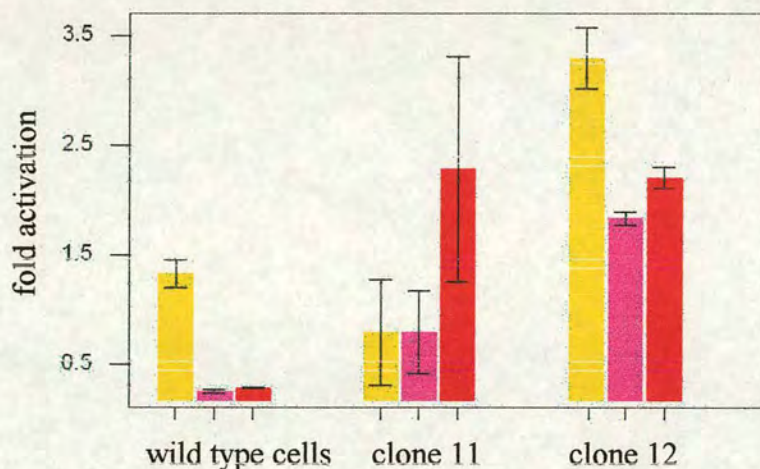

- mock transfection
- transfecting DNA mixture composition:  
pRL-TK (10%), AML1B responsive construct (10%), unspecific DNA (80%)
- transfecting DNA mixture composition:  
pRL-TK (10%), AML1B responsive construct (90%)

**Figure 20. Doxycycline failed to induce the luciferase reporter gene expression in transiently transfected undifferentiated AML1/rtTA regulatory ES cells**

E14 (wild type) and the AML1/rtTA regulatory ES cells (clones 11 and 12) were transiently cotransfected with the AML1B responsive construct carrying the firefly luciferase reporter and pRL-TK internal control plasmid. Different concentrations of the AML1B responsive construct in the transfection reaction mixture were assayed: 10% (purple bars) and 90% (red bars); yellow bars represent the mock transfection controls. Doxycycline (1  $\mu\text{g}/\text{mL}$ ) was added to appropriate wells 16 hours after transfection. The cells were lysed 72 hours after transfection and both firefly and *Renilla* luciferase activities were measured in the lysates. The ratios of the normalised firefly luciferase activities between the doxycycline induced and uninduced cells are shown. Each bar represents the mean value of three independent transfection experiments ( $n=3$ ). Error bars show standards errors.

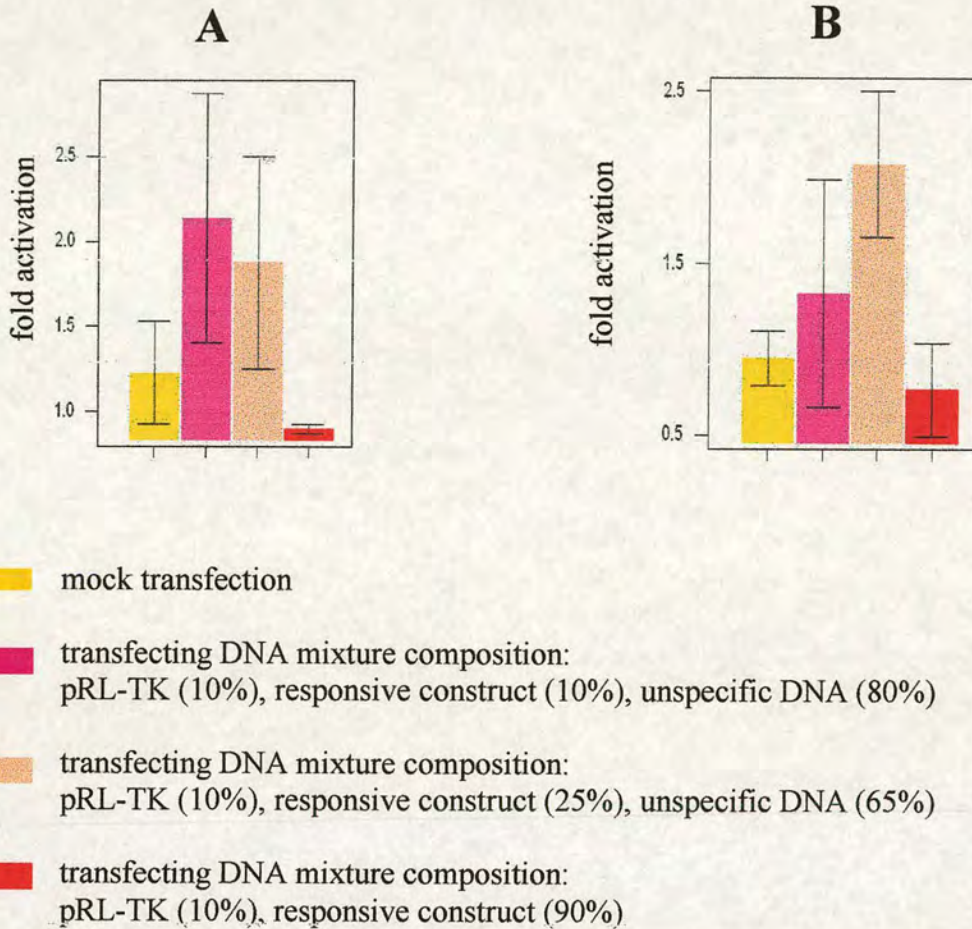

**Figure 21. Doxycycline failed to induce the luciferase reporter gene activation in the transiently transfected differentiated AML1/rtTA regulatory ES cells**

The regulatory ES cells were transiently cotransfected with either the AML1B (A) or pBI-Le (B) responsive construct and pRL-TK internal control plasmid. Different concentrations of the AML1B responsive construct and pBI-Le plasmid in the transfection reaction mixture were assayed: 10% (purple bars), 25% (orange bars) and 90% (red bars); yellow bars represent the mock transfection reactions. The cells were replated into low adhesive dishes with a medium without LIF 16 hours after transfection and at the same time doxycycline (1  $\mu\text{g}/\text{mL}$ ) was added into dishes. The cells were lysed 72 hours after transfection and both firefly and *Renilla* luciferase activities were measured in the lysates. The ratios of the normalised firefly luciferase activities between the doxycycline induced and uninduced cells are shown. Each bar represents the mean value of three independent transfection experiments ( $n=3$ ). Error bars show standards errors.

mass) and a responsive plasmid (10, 25 or 90% of the total DNA mass). The control mock transfection was set up in parallel. Each transfection experiment was repeated three times. Transfected cells were replated into low adhesive (bacterial) dishes with medium in the absence of LIF 16 hours after transfection. ES cells formed embryoid bodies what increased the levels of AML1/rtTA expression (see Chapter 5.6). At the same time the doxycycline (1  $\mu\text{g}/\text{mL}$ ) was supplemented to the culture. The cells were lysed 72 hours after transfection and the firefly and *Renilla* luciferase activities were measured (see Figure 21). The background levels of both *Renilla* and firefly luciferase activities were detected in mock transfected cells lysates. The transfected cell lysates showed the elevated levels of the *Renilla* luciferase activity suggesting that the cells had been transfected properly. However, the levels of the *Renilla* luciferase activity observed in this experiment was considerably lower than in previous one. Presumably, the most part of the transfected DNA had been lost during replating. Similar to previous experiments levels of the firefly luciferase activity were very low and no more than two fold reporter induction by doxycycline was observed.

### 6.2.3. Transfection of B8 ES cells with responsive constructs

I suppose that the failure to induce the reporter expression by doxycycline in the transiently transfected cells might be caused by the following: (i) rtTA was not working, or (ii) the responsive constructs were not working, or (iii) both of them were not working. I first tested if the responsive constructs are functional. For this purpose B8 ES cells kindly provided by Dawn Fisher and Dr. Andrew Smith (University of Edinburgh) were used. B8 ES cells contain the rtTA2<sup>S</sup>-M2 transgene (see Chapter 2.2.2.3) targeted into the HPRT (hypoxantine phosphoribosyltransferase) gene locus. The rtTA2<sup>S</sup>-M2 transgene is driven by the CMV promoter followed by the IRES EGFP reporter unit. The cells were plated into 12-well plates and co-transfected with the experimental (90% of the entire transfected DNA) and pRL-TK control (10% of the entire transfected DNA) plasmids. Three experimental plasmids containing the firefly luciferase reporter driven by bTRP (pBI-L, pBI-Le and the AML1B responsive construct (see Figure 18)) were tested. The control mock transfection was set up in parallel. Each transfection experiment was repeated 3 times. The cells were growing in the LIF-containing medium during entire experiment. Doxycycline (final concentration 1  $\mu\text{g}/\text{mL}$ ) was added 24 hours after transfection, the cells were lysed 48 hours after transfection and luciferase activities were measured in the lysates (see Figure 22).

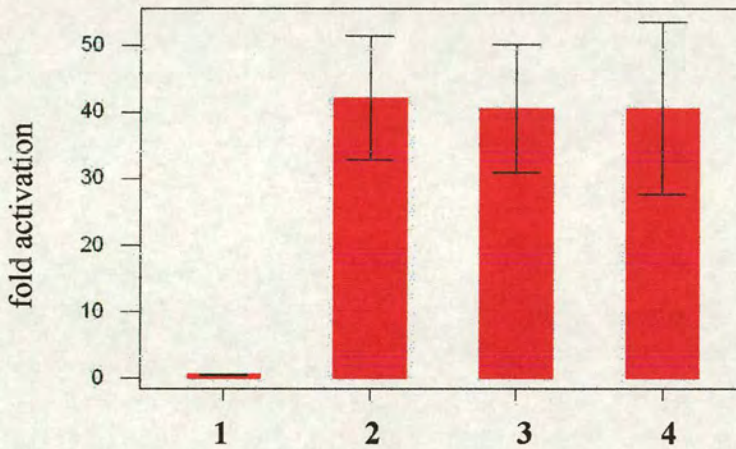

**Figure 22. Doxycycline induced the 40 fold luciferase reporter gene activation in the transiently transfected B8 cells**

The B8 ES cells were transiently cotransfected with either pBI-L (2) or pBI-Le (3) or the AML1B responsive construct (4) and pRL-TK internal control plasmids. Doxycycline (1  $\mu\text{g}/\text{mL}$ ) was added to cells 24 hours after transfection. The cells were lysed 48 hours after transfection and both firefly and *Renilla* luciferase activities were measured in the lysates. The ratios of the normalized firefly luciferase activities between the doxycycline induced and uninduced cells are shown. The bar (1) shows the mock transfected control. Each bar represents the mean value of three independent transfection experiments ( $n=3$ ). Error bars show standards errors.

The firefly and *Renilla* luciferase activities did not exceed the background levels in the mock transfected cells; however the high levels of the *Renilla* luciferase activity were detected in all other transfectants. The firefly luciferase activity was induced by doxycycline about 40 times in all cells transfected with experimental plasmids. No difference between luciferase activities among the cells transfected with different experimental plasmids was observed.

Conditions used in transfection of B8 cells were different from those of AML1/rtTA regulatory cells. B8 cells were induced 24 hours after transfection and lysed 48 hours after transfection, whereas the AML1/rtTA regulatory cells were induced 16 hours after transfection and lysed 72 hours after transfection. It is not likely that AML1/rtTA regulatory cells lost transfected plasmids during the prolonged incubation period since the levels of *Renilla* luciferase activity were similar in both B8 and AML1/rtTA regulatory cells. Therefore, I concluded that the luciferase responsive constructs were functional and the failure to induce the luciferase expression by doxycycline in the AML1/rtTA regulatory ES cells had been caused by either the insufficient levels of the rtTA expression or by its lack of function. Although I have shown by RT-PCR that the knocked-in rtTA is expressed in a similar manner as AML1 the functional activity of the protein has not been proved. However, since all ways to solve this problem are very laborious I decided to change the strategy and generate a new responsive ES cell line (see Chapter 7). However, the reporter constructs have been used to generate responsive mouse strains.

### **6.3. Generation of responsive mouse strains**

#### **6.3.1. Generation of the EYFP responsive constructs**

The reporter constructs for the responsive mouse strains generation were created on the basis of the bi-directional pBI-L vector (see Figure 23). The luciferase reporter was substituted with the enhanced yellow fluorescent protein (EYFP). Thus reporter constructs encode bTRP driving both AML1 cDNA and EYFP in opposite directions. EYFP allows non-invasive control of gene expression in live tissues providing a tool for monitoring and sorting out the AML1 overexpressing cells (reviewed by Naylor 1999). In order to be able to exclude a possible role of EYFP in the phenotype of transgenic mice the AML1 cDNA was flanked by *loxP* sites. This design allows Cre-mediated deletion of AML1 cDNA and as a result generation of control transgenic mice which overexpress EYFP only. This can be achieved for

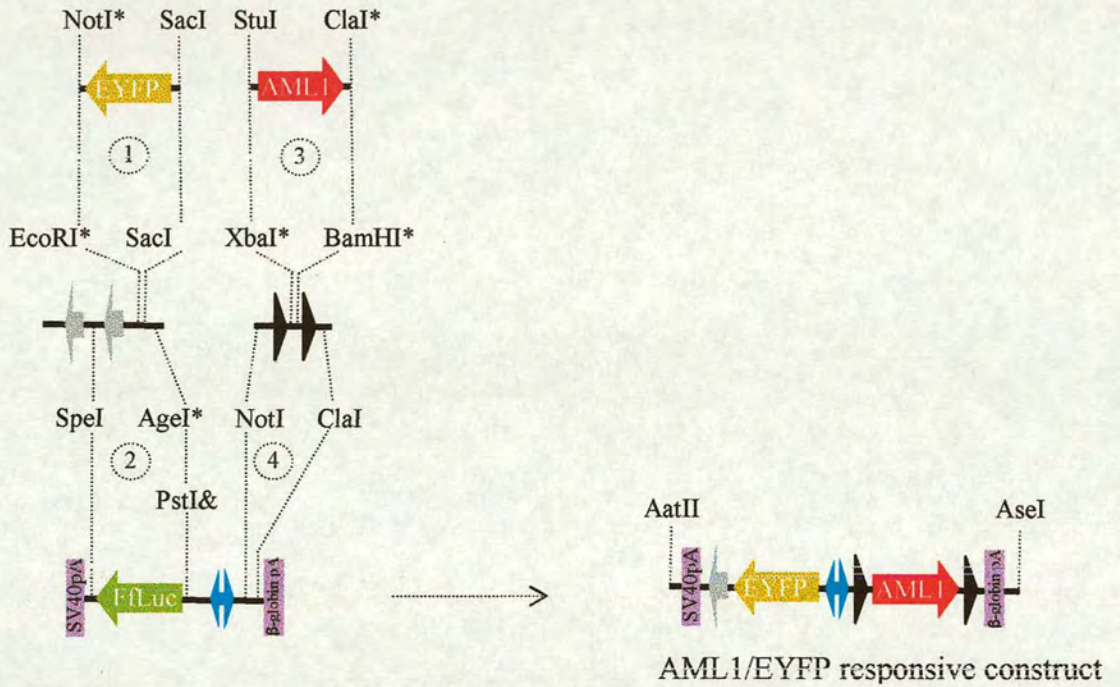

**Figure 23. Diagram of the four step cloning of the AML1/EYFP responsive construct**

1. Cloning of EYFP into the FRT sites encoding plasmid
2. Replacement of luciferase with EYFP-FRT in the pBI-L vector
3. Cloning of the AML1 cDNA into the *loxP* sites encoding plasmid
4. Cloning of the floxed AML1 cDNA into the pBI-EYFP vector

Two responsive constructs with different isoforms of AML1 (A and B) were generated. Restriction sites marked with asterisks had generated 5' overhangs which were filled-in after digestion. A restriction site marked with an ampersand generated 3' overhangs which were removed. Gray arrow marks an FRT site; black triangle denotes a *loxP* site; blue left-right arrow marks bTRP.

example by crossing these mice with the ZP3-Cre females (Lewandoski et al., 1997). The responsive mouse strains are designed to be generated by pronuclear injections. Exogenous DNA usually forms an array at the site of integration (reviewed by Palmiter and Brinster 1986). The construct is designed to incorporate one *frt* (Flp recognition target) site which is the target for the yeast site-specific recombinase Flp (Senecoff et al. 1985; McLeod et al. 1986). Expression of Flp will excise DNA flanked by *frt* sites. Therefore, the number of copies of the transgene may be reduced if necessary. This can be achieved either by pronuclear injection of the Flp-expressing plasmid or by intercrossing the AML1/EYFP responsive and Flp-expressing mice.

The EYFP responsive constructs with two individual AML1 isoforms were generated using four step cloning procedure (see Figure 23). The first and second cloning steps were aimed to the pBI-EYFP vector generation. For this purpose, the 0.7 kb EYFP insert was prepared by subsequent treatments of the pEYFP-N1 plasmid ("Clontech") with the Not I, T4 DNA polymerase and Sac I enzymes. Not I linearised the plasmid downstream the EYFP insert. Protruding 5' ends were filled-in using the T4 DNA polymerase. Sac I digested the plasmid upstream the EYFP insert. Therefore, the insert with the blunt and 3' protruding Sac I compatible ends was generated. The EYFP insert was ligated into the 3.1 kb pdFRT vector generated by subsequent treatments with the Eco RI, T4 DNA polymerase and Sac I enzymes. The pdFRT plasmid (kindly provided by Dr. Igor Samokhvalov, The University of Edinburgh) encodes two *frt* sites in the head-to-tail orientation. Both Eco RI and Sac I enzymes digest the plasmid upstream the *frt* sites tandem. Subsequent treatment by three enzymes generated the vector with the blunt and 3' protruding Sac I compatible ends. The recombinant molecules with the EYFP insert upstream the *frt* sites tandem were selected and used for the second cloning step. During the second cloning step the 0.8 kb insert was excised from the pdFRT-EYFP plasmid by subsequent treatments with the Age I, T4 DNA polymerase and Spe I enzymes. The Spe I restriction site is located between the *frt* sites while the Age I site is located upstream EYFP. Therefore, the EYFP-FRT insert with the 5' protruding Spe I compatible and blunt ends was generated. The insert was ligated into the 4.4 kb vector prepared by subsequent treatments of the pBI-L plasmid ("Clontech") with the Pst I, T4 DNA polymerase and Spe I enzymes. This treatment released the firefly luciferase insert from the vector generating the blunt and 5' protruding Spe I compatible ends. The recombinant molecules with the EYFP-FRT insert were selected. These molecules are the pBI-EYFP vectors which encode bTRP driving the EYFP reporter gene

followed by the *f<sub>rt</sub>* site and the SV40 polyadenylation signal. Furthermore, the pBI-EYFP encodes MCS followed by the rabbit  $\beta$ -globin polyadenylation signal. The AML1 floxed cDNA was cloned into MCS of the pBI-EYFP vector during the third and fourth cloning steps.

During the third cloning step the AML1 floxed cassettes were generated. For this purpose, the AML1A and AML1B cDNAs were excised from the pLNSX vector using the *Stu* I and *Cla* I restriction enzymes (see Chapters 4.2 for the pLNSX-AML1 plasmids description). This released the 0.8 kb AML1A and 1.4 kb AML1B inserts. The 5' protruding *Cla* I ends were filled-in using the T4 DNA polymerase generating inserts with both blunt ends. Then, the inserts were ligated into the 3 kb pROSA vector digested with *Bam* HI and *Xba* I enzymes. Again, the vector blunt ends were generated by the filling-in the 5' protruding *Bam* HI and *Xba* I ends using T4 DNA polymerase. pROSA is a cloning vector encoding two *loxP* sites in the head-to-tail orientation (kindly provided by Dr. Igor Samokhvalov, The University of Edinburgh). The *Bam* HI and *Xba* I enzymes digest the pROSA vector between the *loxP* sites. Recombinant molecules with the head-to-tail orientation of the *loxP* sites and insert were selected. The rationale of this selection was that the *loxP* site antisense chain encodes two ATG codons which may act as the translation initiators whereby inhibiting the AML1 initiator ATG. During the fourth cloning step, the floxed 0.9 kb AML1A and 1.5 kb AML1B inserts were excised from their vectors using the *Not* I and *Cla* I restriction enzymes. The inserts were ligated into the 5.2 kb pBI-EYFP vector pretreated with the same enzymes. *Not* I and *Cla* I digested MCS between bTRP and the  $\beta$ -globin polyadenylation signal. Recombinant molecules were selected, and correct sequence of all functional regions was confirmed. Therefore, I produced constructs which contain bTRP driving simultaneous transcription of the AML1 cDNA and EYFP reporter and in which the AML1 cDNA is floxed.

### **6.3.2. Generation of the AML1/EYFP responsive mice**

For pronuclear microinjections DNA inserts that encode AML1 cDNA and EYFP driven by bTRP were excised from the vectors using *Aat* II and *Ase* I restriction enzymes (see Figure 23). The size of the AML1A transgene was 4.05 kb and of the AML1B transgene was 4.65 kb. Pronuclear microinjections were performed by Mauro Tolaini (National Institute for Medical Research (NIMR), London). Founders and offsprings from further backcrossings were screened by

Southern blot hybridisation at ISCR and NIMR. For this purpose, genomic DNA isolated from mouse biopsies was digested using the Eco RV enzyme and cosecutively hybridised with the exon 3 AML1 and EYFP probes. The exon 3 AML1 hybridisation probe was obtained by PCR while the 0.7 kb EYFP cloning insert was used as a hybridisation probe. The Eco RV restriction site is unique in both AML1/EYFP responsive constructs. It is located between the 3' *loxP* site and rabbit  $\beta$ -globin polyadenylation signal. Since usually pronuclear injected DNA forms a multicopy array at the site of integration (reviewed by Palmiter and Brinster 1986) three possible versions of integrations should be considered. These are head-to-tail, head-to-head and tail-to-tail tandems. The Table 2 shows the length of hybridisation fragments obtained by hybridisation of the Eco RV digested AML1A/EYFP or AML1B/EYFP genomic DNA with either the exon 3 AML1 or EYFP probes (see Figures 24 and 26).

Table 3. Length of hybridisation fragments

Arrangement of integrants	Responsive construct	
	AML1A/EYFP	AML1B/EYFP
Head-to-tail	4.05 kb	4.65 kb
Head-to-head	5.74 kb	6.94 kb

The length of the AML1A/EYFP fragment used for pronuclear injections is 4.05 kb. The Eco RV digestion generates two restriction fragments of 2.87 and 1.18 kb (see Figure 24). The 1.18 kb fragment contains the rabbit  $\beta$ -globin polyadenylation signal while the 2.87 kb fragment contains the rest of the molecule. Therefore, both the exon 3 AML1 and EYFP probes hybridise to the 2.87 kb fragment only. In the case of the head-to-tail dimerisation, the Eco RV enzyme generates restriction fragments of the length of the injected construct (4.05 kb) which bind both the exon 3 AML1 and EYFP probes. In the case of two 2.87 kb fragments junction (head-to-head tandem) the probes hybridise to the 5.74 kb fragment. The 1.18 kb fragment cannot be hybridised to the probes, therefore the tail-to-tail tandems give no specific hybridisation bands.

The length of the AML1B/EYFP fragment used for the pronuclear injections is 4.65 kb (see Figure 26). The Eco RV enzyme digests it upstream the rabbit  $\beta$ -globin polyadenylation signal generating two fragments: 1.18 kb (rabbit  $\beta$ -globin

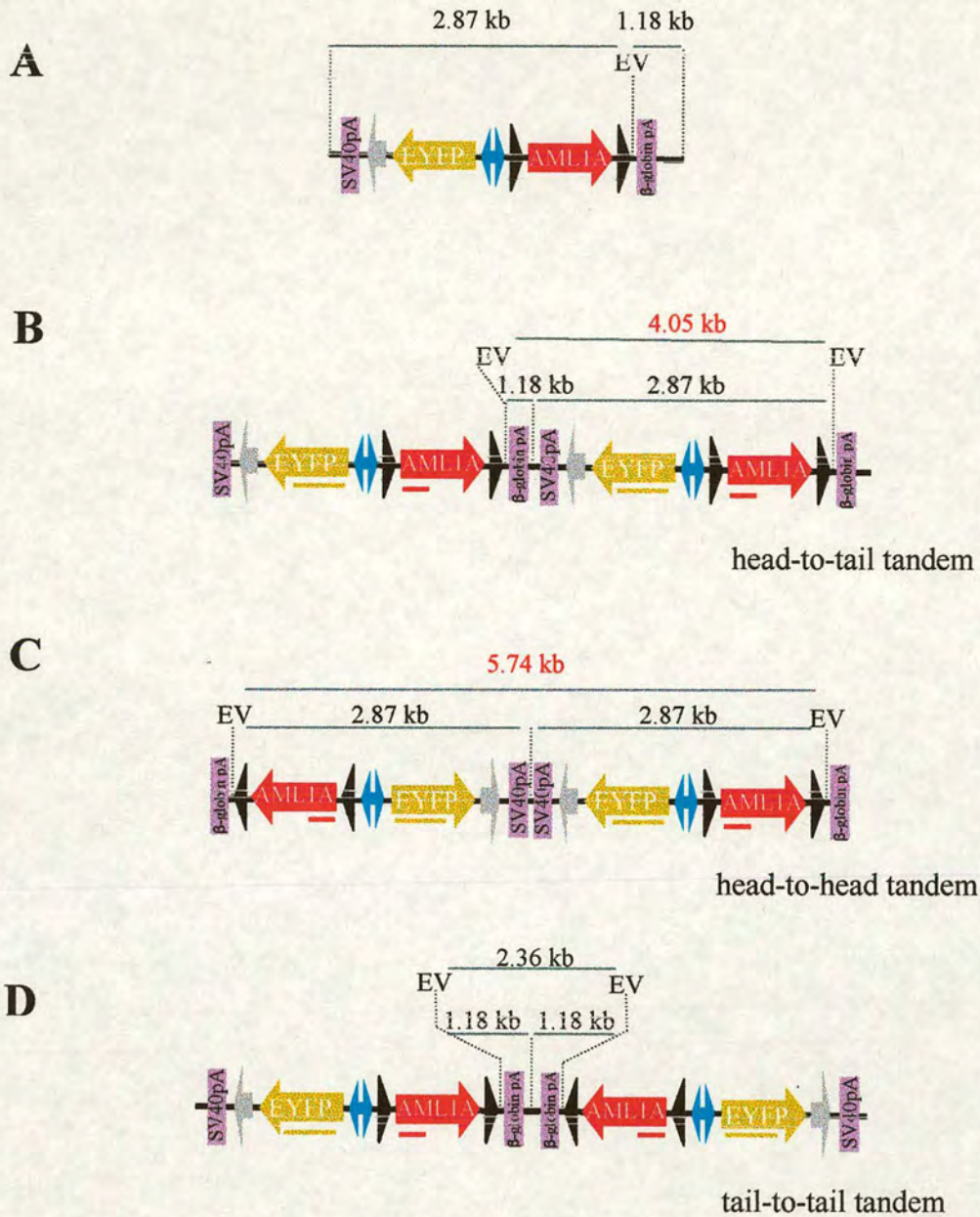

**Figure 24. Possible arrangements of AML1A/EYFP integrants in the genome**

The 4.05 kb AML1A/EYFP fragment used for pronuclear injections generates the 1.18 and 2.87 kb restriction fragments upon the Eco RV (EV) enzyme digest (A). Three possible arrangements of the transgene DNA in the genome are shown: head-to-tail (B), head-to-head (C) and tail-to-tail (D) tandems. Hybridisation probes are designated by red (exon 3 of AML1) and yellow (EYFP) lines. Lengths of hybridisation fragments are shown in red while lengths of the initial restriction fragments are designated by black. Gray arrow marks an FRT site; black triangle denotes a *loxP* site; blue left-right arrow marks bTRP.

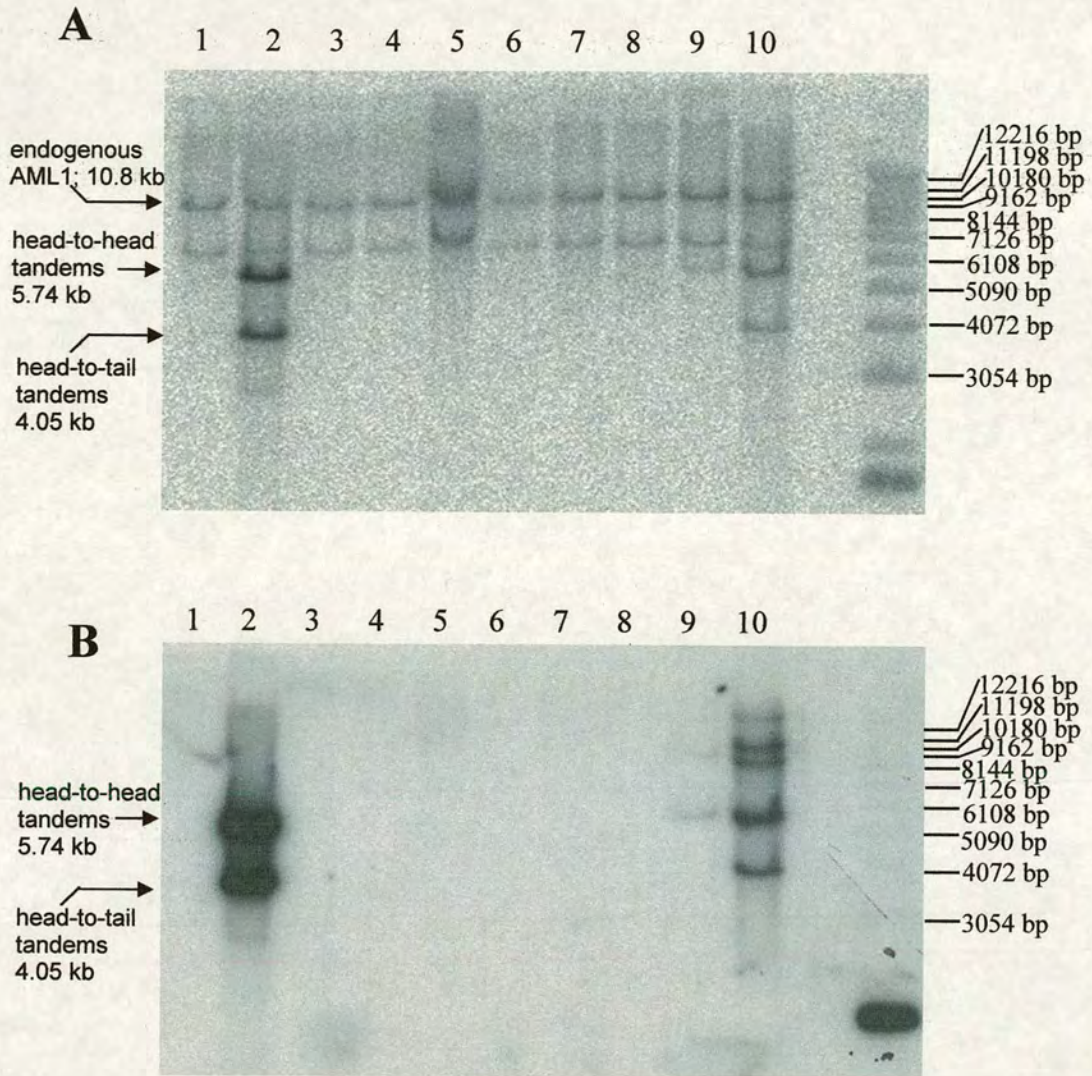

**Figure 25. Southern blot hybridisation of genomic DNA isolated from the AML1A/EYFP transgenic mice biopsies**

Genomic DNA was digested using the Eco RV restriction enzyme. The blot was hybridised with the exon 3 AML1 probe (A), stripped off and rehybridised with the EYFP probe (B).

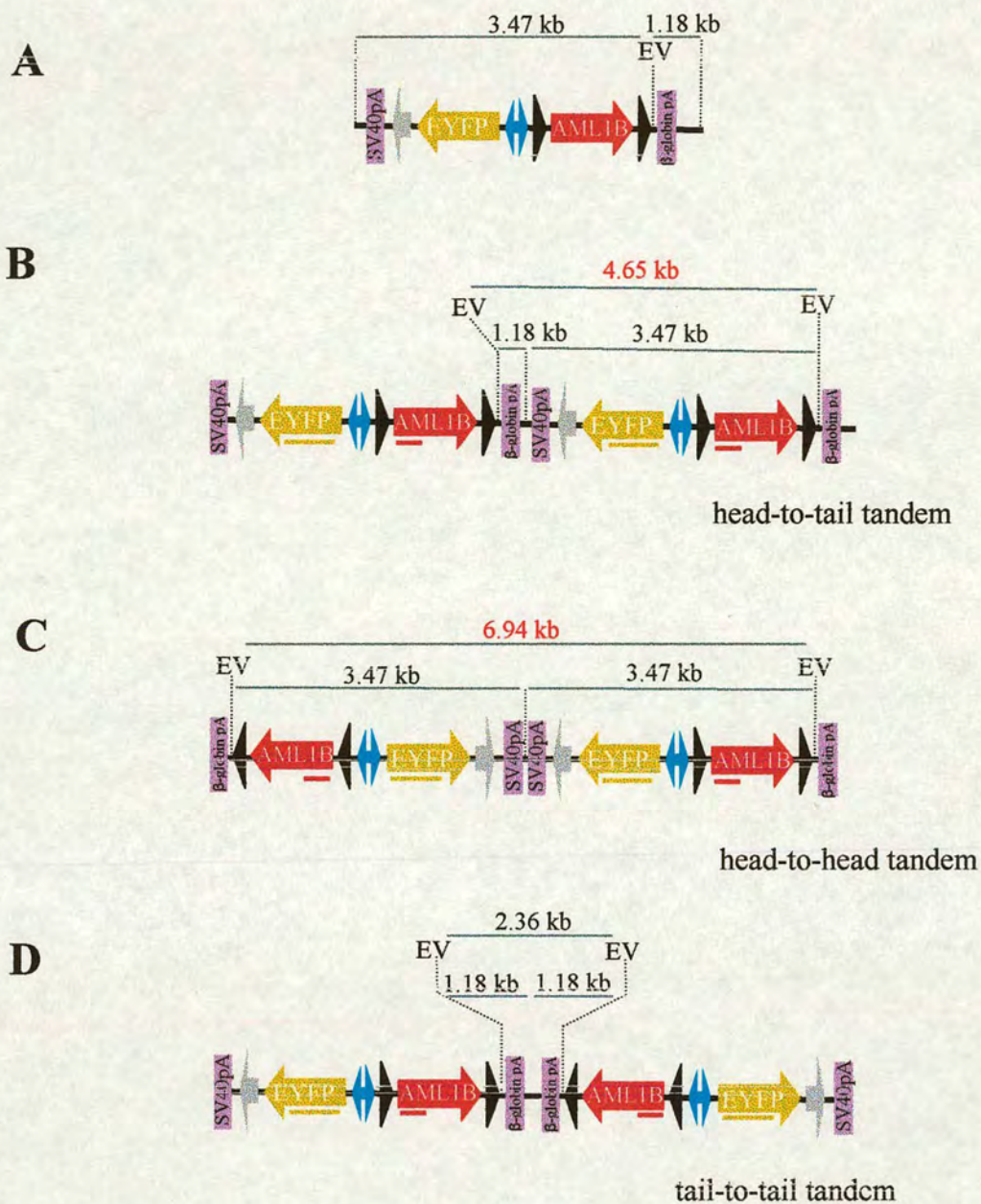

**Figure 26. Possible arrangements of the AML1B/EYFP integrants in genome**

The 4.65 kb AML1B/EYFP fragment used for pronuclear injections generates the 1.18 and 3.47 kb restriction fragments upon the Eco RV (EV) enzyme digest (A). Three possible arrangements of the transgene DNA in the genome are shown: head-to-tail (B), head-to-head (C) and tail-to-tail (D) tandems. Hybridisation probes are designated by brown (exon 3 of AML1) and yellow (EYFP) lines. Lengths of hybridisation fragments are shown in red while lengths of the initial restriction fragments are designated by black. Gray arrow marks an *ftr* site; black triangle denotes a *loxP* site; blue left-right arrow marks bTRP.

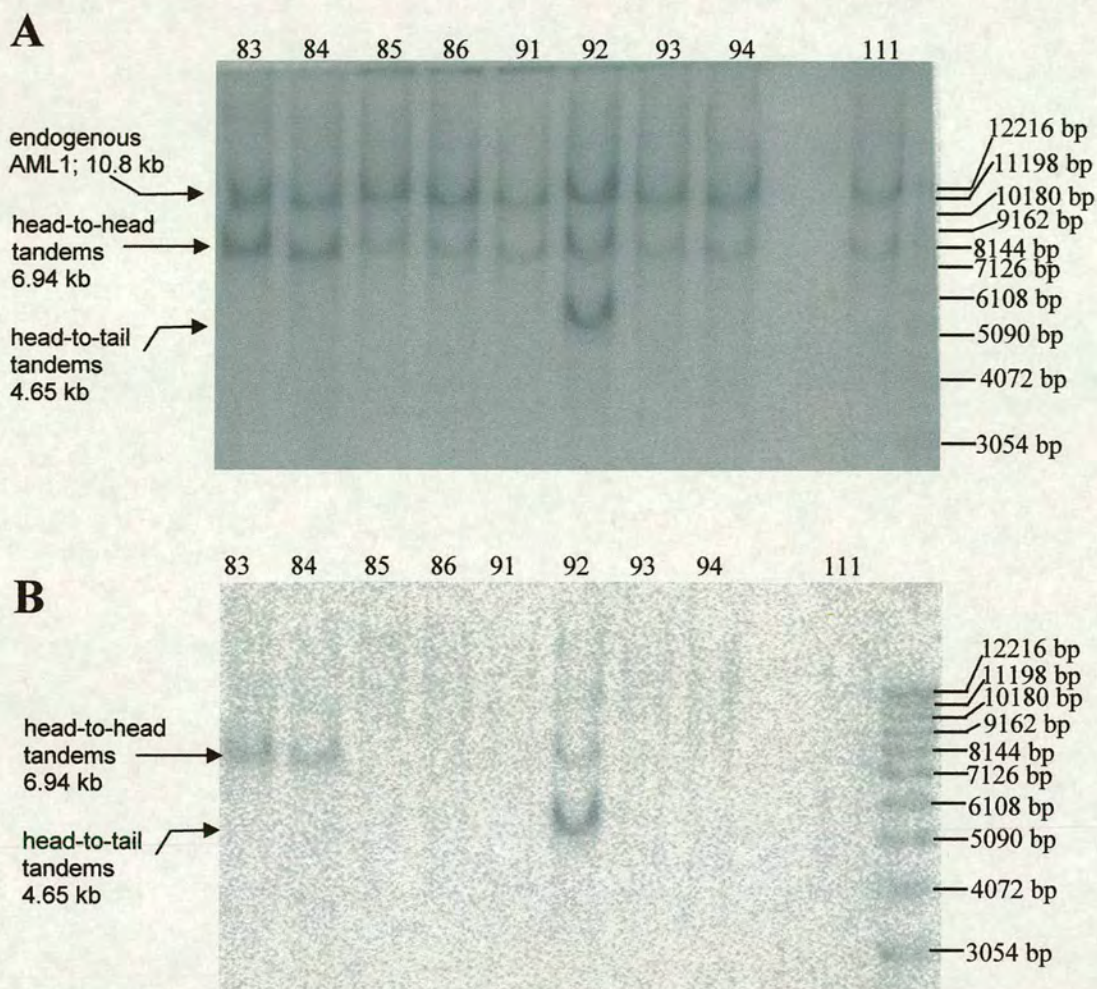

**Figure 27. Southern blot hybridisation of genomic DNA isolated from the AML1B/EYFP transgenic mice biopsies**

Genomic DNA was digested using the Eco RV restriction enzyme. The blot was hybridised with the exon 3 AML1 probe (A), stripped off and rehybridised with the EYFP probe (B).

polyadenylation signal) and 3.47 kb (the rest of the molecule). Both exon 3 AML1 and EYFP probes hybridise to the 4.65 kb fragment in the case of head-to-tail dimerisation and 6.94 kb fragment in the case of head-to-head dimerisation. No specific bands can be produced in the case of tail-to-tail dimerisation.

Representative results of the AML/EYFP mice genotyping are shown at Figures 25 and 27. All samples of the Eco RV digested genomic DNA gave bands of 6.5-7 kb and 10-11 kb when hybridised with the exon 3 AML1 probe. The 10-11 kb band is the endogenous AML1 gene since the 10.8 kb Eco RV restriction fragment encompasses the exon 3 of AML1 in mouse genome according the GeneBank data. The origin of the 6.5-7 kb band is not clear, but it may be either the AML2 or AML3 gene fragment hybridised to the AML1 probe.

Figure 25 shows results of genotyping of the AML1A/EYFP mice. 3 out of 10 genotyped mice are transgenics (samples 2, 9 and 10). Transgenic DNA is arranged into head-to-head tandems in all transgenic mice (5.74 kb hybridisation band) and into head-to-tail tandems in the mice 2 and 10 (4.05 kb hybridisation band). These bands were hybridised to both exon 3 AML1 and EYFP probes. All transgenic samples contain extra-bands of different lengths. This may be caused by (i) integrants at margins of arrays which may give a hybridisation band of any length, (ii) several sites of integration that increases the number of marginal integrants and variability of extra-bands, (iii) integration of incomplete copies of the construct.

Figure 27 shows results of genotyping of the AML1B/EYFP mice. 3 mice (83, 84 and 92) are transgenics. All of them contain the head-to-head tandems (6.94 kb hybridisation band), and the mice 92 contains the head-to-tail tandem (4.65 kb hybridisation band). The 6.94 kb transgenic specific band coincides with the 6.5-7 kb common band when hybridised with the exon 3 AML1 probe. Therefore, re-hybridization of the blots with the EYFP probe is necessary to detect the 6.94 kb transgenic specific hybridisation band.

### **6.3.3. Doxycycline inducible EYFP expression in responsive mice**

All further test experiments with the AML1/EYFP responsive mice to detect functional activity of the transgene were performed and results were kindly provided by Drs Nicky Harker and Dimitris Kioussis (NIMR, London). The AML1/EYFP responsive mice were intercrossed with the CD2-rtTA regulatory mice containing the

rtTA transgene (Gossen et al. 1995) driven by the human CD2 promoter (Legname et al. 2000). The CD2 promoter is active in all T-cells beginning from the DN stage (reviewed by Springer 1990). Induction of the EYFP reporter expression by doxycycline in double transgenic mice was tested (see Figure 28). For this purpose, mice received 1 mg of doxycycline per 1 g of food for the duration of 4 days. After that, the mice were sacrificed and single cell suspensions prepared from their thymi. Following staining with anti-CD4 and anti-CD8 antibodies the cells were analysed by flow cytometry. Administration of doxycycline induced the EYFP expression in all analysed cell populations (see Figure 28A); whereas no EYFP expressing cells were found in the absence of doxycycline (see Figure 28B). The difference in the levels of EYFP expression between cell populations presumably reflects changes in the CD2 promoter activity associated with cell differentiation.

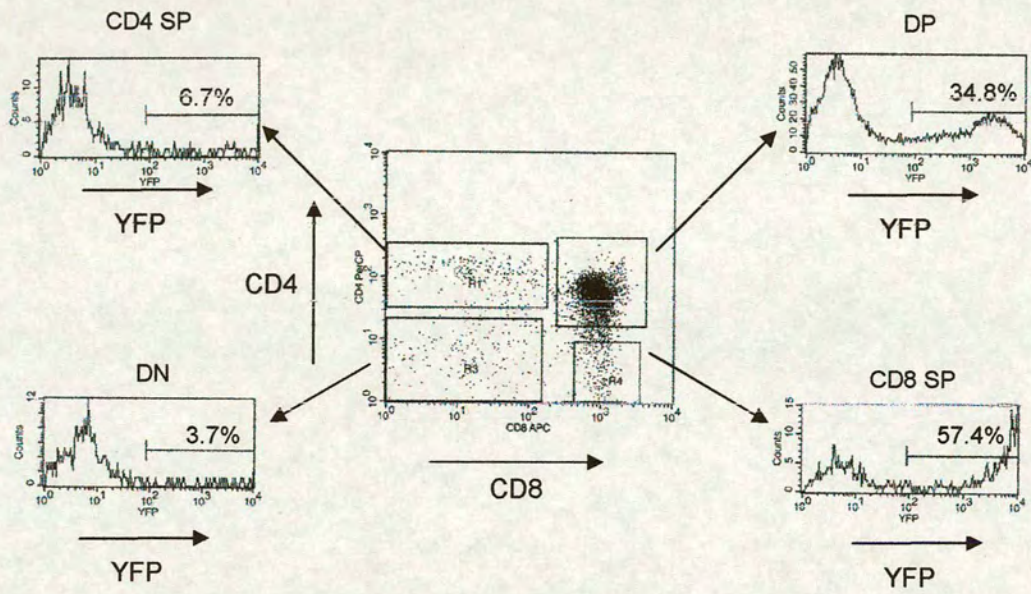
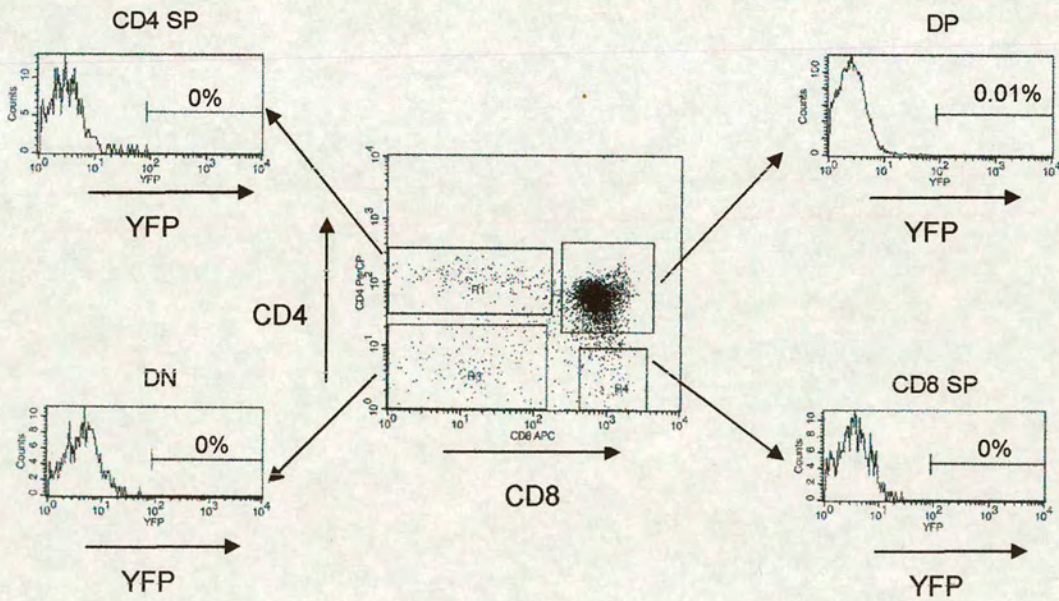
**A****B**

**Figure 28. Doxycycline induces EYFP expression in thymocytes of double transgenic mice**

**(kindly provided by Dr. Nicky Harker)**

AML1A/EYFP-rtTA double transgenic mice got 1 mg of doxycycline per 1 g of food for 4 days (**A**) while the control group of mice got no doxycycline (**B**). Single cell suspension of the mouse thymocytes was stained with anti-CD4 and anti-CD8 antibodies and analysed by flow cytometry. CD4/CD8 dot plot is shown for total thymus (center). Histograms demonstrate EYFP expression in DN (double negative), CD4/CD8 SP (single positive) and DP (double positive) thymic cell populations. The percentage of the EYFP positive cells in each cell population is indicated.

## Chapter 7: RESULTS

### Inducible expression of the AML1 isoforms: Tet-On/HPRT gene expression system

#### 7.1. Introduction

The AML1/rtTA regulatory ES cells were generated but difficulties in proving functionality of these cells were experienced. It became clear that generating a reliable regulatable system would be a problem and I started to search for an alternative solution. At that time, a paper describing an elegant regulatable system (Tet-On/HPRT system) was published (Kyba et al. 2002). Therefore, the strategy was changed and a new Tet-On/HPRT system for inducible regulation of AML1 isoforms was designed based on this system.

As other tetracycline inducible systems, the Tet-On/HPRT system consists of two genetic elements (regulatory and responsive) integrated in the genome. The original Ainv15 cells are designed to introduce any cDNA and make its expression tetracycline-inducible. The regulatory element of the Tet-On/HPRT system is rtTA (NLS-rtTA) targeted into ubiquitously expressed ROSA26 gene locus of ES cells (Gossen et al. 1995; Zambrowicz et al. 1997) (see Figure 29). Therefore the system should be working in all cell lineages differentiated from ES cells. The responsive element of the Tet-On/HPRT system consists of TRP followed by the *loxP* site,  $\Delta$ Neo transgene and PGK (phosphoglycerate kinase) polyadenylation signal. They are integrated into the 5' end of the HPRT locus of the ROSA26-rtTA cells and form the HPRT homing site for the exogenous cDNA targeting. The  $\Delta$ Neo transgene is a non-functional deletion mutant of the Neo<sup>r</sup> gene. It lacks nucleotides encoding the first five N-terminal amino acids (including the initiator ATG) of the Neo<sup>r</sup> protein. Therefore, the original Ainv15 cells are G418 sensitive.

A tetracycline regulatable transgene can be introduced into Ainv15 cells using so-called single *loxP* targeting strategy, based on the Cre-mediated recombination between chromosomal and extrachromosomal *loxP* sites (reviewed by Sauer 2002). In Ainv15 cells *loxP* site is introduced into the HPRT homing site. A specially designed pLox plasmid which encodes the PGK promoter that is followed by a *loxP* site, ATG codon and cloned cDNA of interest is used for integration of the cDNA into the genome of Ainv15 cells. Cre catalyses recombination between the

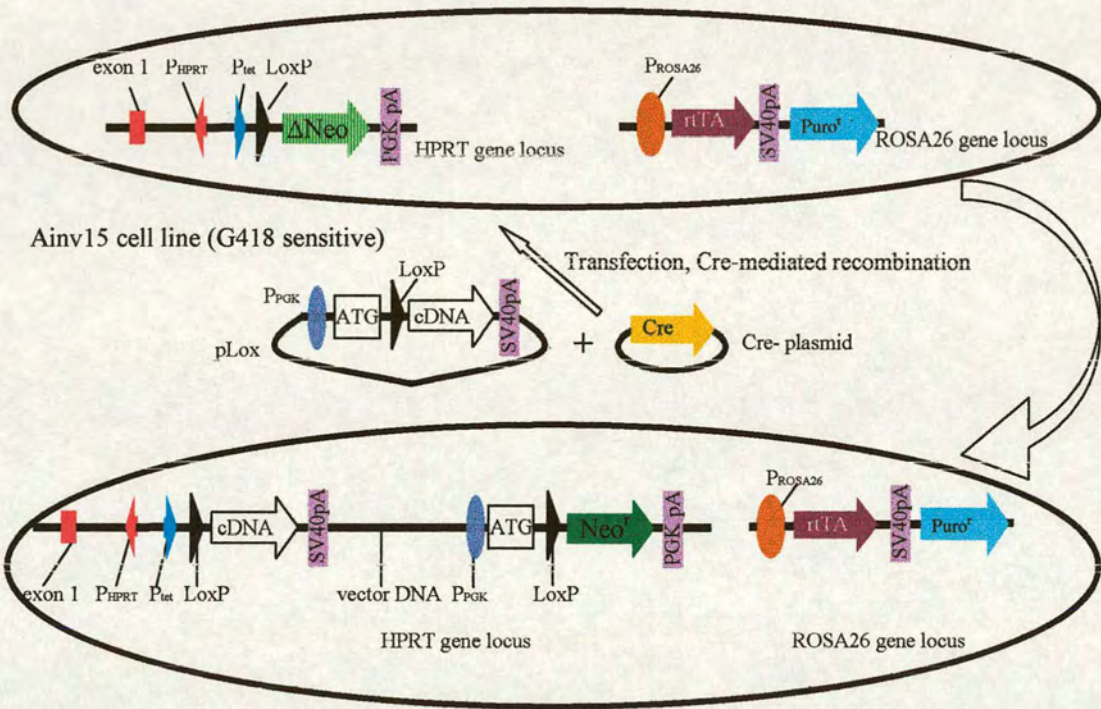

Ainv15 cell line with inserted cDNA (G418 resistant)

### Figure 29. Tet-On/HPRT gene expression system

Ainv15 ES cells contain the rtTA transgene targeted into the ROSA26 gene locus. They also contain HPRT homing site which consists of TRP, *loxP* site, ΔNeo transgene and PGK polyadenylation signal which are targeted upstream of the HPRT gene locus. Cre recombinase catalyses site-specific recombination between the *loxP* sites in the HPRT homing site and pLox plasmid. The pLox plasmid encodes the PGK promoter, initiator ATG, cDNA of interest and SV40 polyadenylation signal. Upon Cre-mediated DNA insertion of TRP driving cDNA into the HPRT homing site the functional Neo<sup>r</sup> gene is restored since the PGK promoter and initiator ATG are incorporated upstream the ΔNeo transgene. As a result Ainv15 cells become G418 resistant and can be selected.

extrachromosomal (plasmid) and chromosomal *loxP* sites if the Ainv15 cells are coelectroporated with the pLox and Cre-expressing plasmids. As a result the cDNA integrates into the HPRT homing site (see Figure 29). In correctly recombined clones the functional  $\text{Neo}^r$  gene restores and these cell clones can be selected in presence of G418. Since the cells also contain rtTA, the cDNA expression can be induced by the doxycycline. The Tet-On/HPRT gene expression system has been successfully employed to investigate the role of HoxB4 and STAT5 gene in the haematopoietic differentiation (Kyba et al. 2002; Kyba et al. 2003).

The integrated cDNA is floxed and can be excised in presence of Cre-recombinase. Excision of the cDNA is an intramolecular reaction and therefore may prevail over the intermolecular insertion reaction. However, once site-specific recombination restores the functional  $\text{Neo}^r$  gene selection of these rare G418 resistant clones becomes practically achievable. Both random integrants and non-transfected cells remain drug sensitive and disappear in presence of G418. The single *loxP* site targeting strategy has been successfully employed in both yeast and mammalian cells (Sauer and Henderson 1990; Fukushige and Sauer 1992). It has been shown that the complete elimination of random integrants may be achieved if the recombination event is necessary for the  $\text{Neo}^r$  both transcription and translation restoration. Another important feature of the single *loxP* site targeting strategy is that one cDNA copy only is integrated into genome (Fukushige and Sauer 1992). This system ensures efficient and standard site-specific integration of exogenous cDNA of interest and therefore eliminates variability between clones.

## 7.2. Generation of the gene targeting constructs

Plasmids and Ainv15 cells for the Tet-On/HPRT gene expression system were kindly provided by Dr. George Daley (USA). Before starting molecular cloning I sequenced functional regions of all plasmids and found two unexpected features of the pLox plasmid: (i) GC insertion in the *loxP* site and (ii) an ATG triplet upstream MCS (see Figure 30). In order to check the structure of the corresponding *loxP* site within the HPRT gene locus of Ainv15 cells I isolated genomic DNA and the 238 bp fragment encompassing *loxP* site was amplified by PCR and cloned into the pCR2.1 vector for TA cloning (Invitrogene). Bacterial colonies remaining white on the IPTG X-gal containing medium were picked up, propagated and their plasmid DNA was isolated and sequenced. All three clones showed no difference in the 238 bp insert

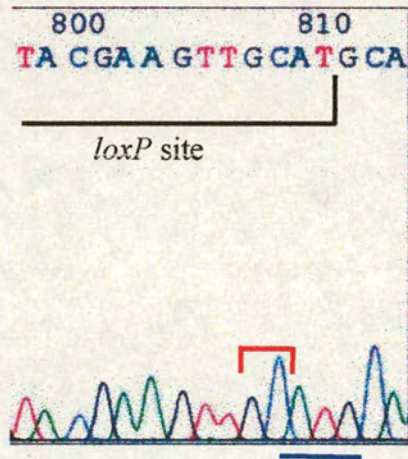

**Figure 30. Sequence of the pLox plasmid**

Fragment of the pLox plasmid sequence is shown. The *loxP* site contains the GC insertion (red bracket). The ATG triplet is underlined (blue line).

structure and no mutation in the *loxP* site (see Appendix for the sequence). However, since the same GC insertion in the extrachromosomal *loxP* site employed in the single *loxP* site targeting strategy was previously described in the literature (Fukushige and Sauer 1992), it is conceivable that the mutation favours Cre-mediated site-specific integration over excision and was introduced into the pLox plasmid deliberately.

The upstream ATG triplet has no Kozak consensus sequence (Kozak 1987; Kozak 1989). However ATG codon without Kozak consensus sequence can be functional (Ho et al. 1995; Tucker et al. 2001). Therefore, the extra ATG in the pLox plasmid was substituted for the ATT codon in order to avoid competition with downstream AML1 translation initiating codon. For this purpose, the pLox plasmid was subsequently treated with the Sph I, T4 DNA polymerase and Kpn I enzymes (see Figure 31). The Sph I enzyme linearised the plasmid within the 3' end part of the *loxP* site. T4 DNA polymerase removed the 3' protruding ends. The Kpn I enzyme digested the plasmid MCS. Therefore, a linearised vector with the blunt and 3' protruding Kpn I compatible ends was generated. An adaptor was ligated into the vector. The adaptor had the blunt and 3' protruding Kpn I compatible ends thereby ensuring its directional cloning. Furthermore, the adaptor contained the Sna BI restriction site used for the recombinant molecules screening. An original *loxP* site with the GC insertion was restored into the modified plasmid called pLoxm. The upstream ATG triplet was substituted for the ATT one.

The constructs for the site-specific recombination were generated using two step cloning procedure (see Figure 32). First, the AML1A and AML1B cDNAs were excised from the pLNSX vector using the Stu I and Cla I restriction enzymes which released 0.8 kb (AML1A) and 1.4 kb (AML1B) inserts (see Chapters 4.2 for the pLNSX-AML1 plasmids description). The inserts were ligated into the 3.6 kb pLoxm vector digested with the Sna BI and Acc I restriction enzymes. These restriction enzymes released the Neo<sup>r</sup>-EGFP insert from the pLoxm vector. Sna BI generated blunt ends compatible with the Stu I ones, while Acc I generated the 5' protruding Cla I compatible ends. Therefore, the inserts were cloned directionally into the vector. Second, the 1.4 kb ECMV IRES fragment was excised from the pPGK-Puro-IRES-EGFP plasmid (kindly provided by Atif Suleman, University of Edinburgh) using the Not I restriction enzyme and ligated independently into the 4.4 kb (pLoxmAML1A) and 5 kb (pLoxmAML1B) vectors linearised using the same enzyme. Not I digested the pLoxmAML1 vectors downstream the AML1 insert.

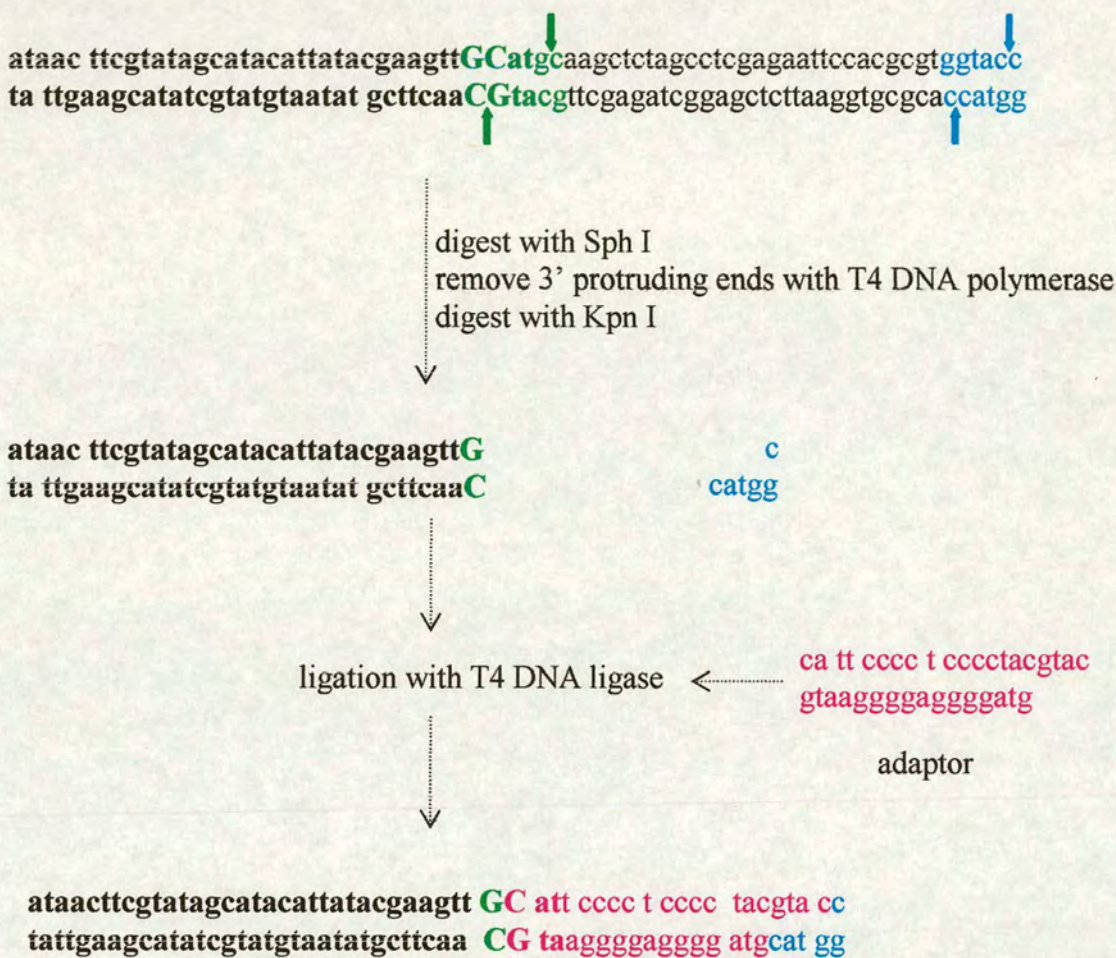

### Figure 31. Modification of the pLox plasmid

The pLox plasmid was digested using the Sph I restriction enzyme (the Sph I recognition site is shown by green), 3' protruding ends were removed using T4 DNA polymerase, and the plasmid was digested again using the Kpn I restriction enzyme (the Kpn I restriction site is shown by blue). An adaptor (shown by purple) with the blunt and 3' protruding Kpn I compatible ends was ligated into the linearised plasmid. The ATG triplet at the 3' end of the *loxP* site was substituted for ATT in the modified molecule. The *loxP* site is shown by bold. The GC insertion in the *loxP* site is shown by capital letters. The *Sna* BI recognition site is underlined.

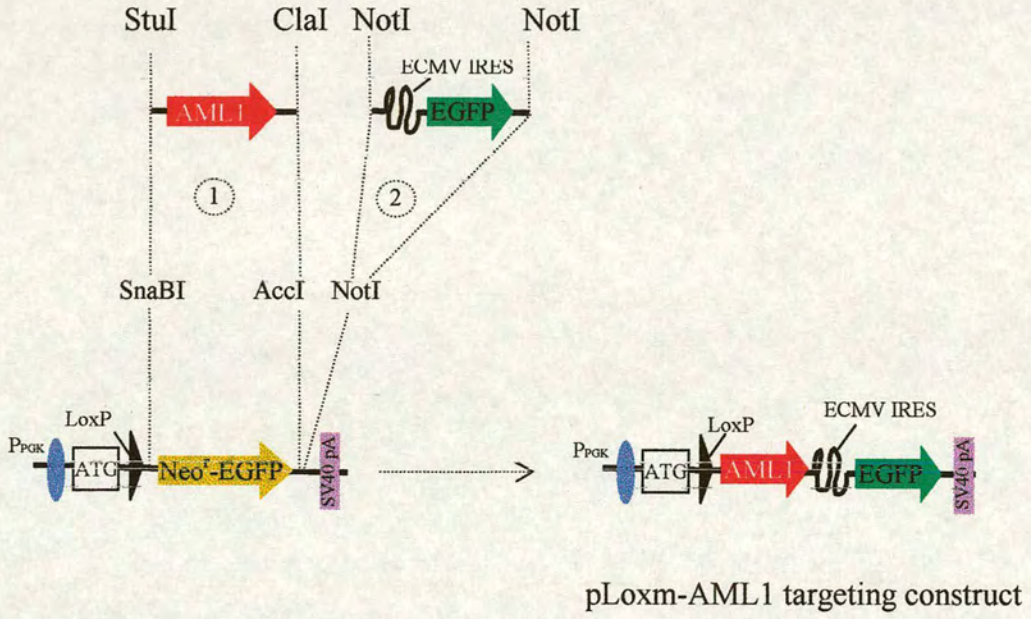

**Figure 32. Diagram of the two steps cloning of the constructs for site-specific recombination.**

1. Cloning of AML1 cDNAs into the pLoxm vector.
  2. Cloning of the IRES-EGFP insert into the pLoxm-AML1 vector.
- Two constructs with different isoforms of AML1 (A and B) were generated.

Recombinant molecules with the head-to-tail orientations of AML1 and EGFP were selected. All functional regions of the constructs were sequenced before targeting.

### **7.3. Targeting of the Ainv15 cells**

Ainv15 cells were co-electroporated with the pLoxm-AML1A (or B) and pSALK-Cre plasmids. The pSALK-Cre plasmid encodes Cre recombinase driven by CMV promoter. Two days after electroporation G418 (final concentration 0.35 mg/mL) was added to cells. Resistant clones were selected and split into two wells of a 12-well plate each. Doxycycline (final concentration 1 µg/mL) was added to one of two wells. 48 hours later, the EGFP expression was analyzed by flow cytometry (see Figures 33 and 34). In all 12 analysed clones EGFP expression was induced that demonstrated high efficiency of the single *loxP* targeting strategy. Two AML1A and two AML1B overexpressing clones were selected for further experiments. For these clones doxycycline induction was tested independently three times. 65-75% of cells expressed EGFP upon the doxycycline addition. A very small number of EGFP positive cells have been found in the absence of doxycycline. Thus, the Tet-On/HPRT gene expression system ensures low background expression which can be significantly induced by the doxycycline.

### **7.4. Self-renewal abilities of Ainv15 cells and its derivatives**

In my initial experiments overexpression of AML1 cDNA isoforms using episomal vectors resulted in growth inhibition of undifferentiated ES cell colonies. Using the Tet-On/HPRT gene inducible system constructed on the basis of Ainv15 cells the cytotoxic effect of AML1 can be more precisely addressed. For this purpose, the equal numbers of the Ainv15-AML1A (and B) and Ainv15 control cells were plated at low density into 6-well plates with medium containing LIF and different amount of doxycycline (see Figure 35). Doxycycline was used at concentrations of 5, 10, 50, 100 and 1000 ng/mL. After 10-14 days of culture self-renewal capacity of the ES cell was assessed using staining for alkaline phosphatase activity. Differentiated ES cells contain no alkaline phosphatase activity whereas the enzyme is highly active in undifferentiated ES cells (Berstine et al. 1973). This experiment was repeated three times. The size and number of the Ainv15 cell colonies were higher than those of the Ainv15-AML1A (and B) cells both with and without doxycycline. Subsequent alkaline phosphatase staining showed that the Ainv15 cell colonies contained more undifferentiated cells than Ainv15-AML1A

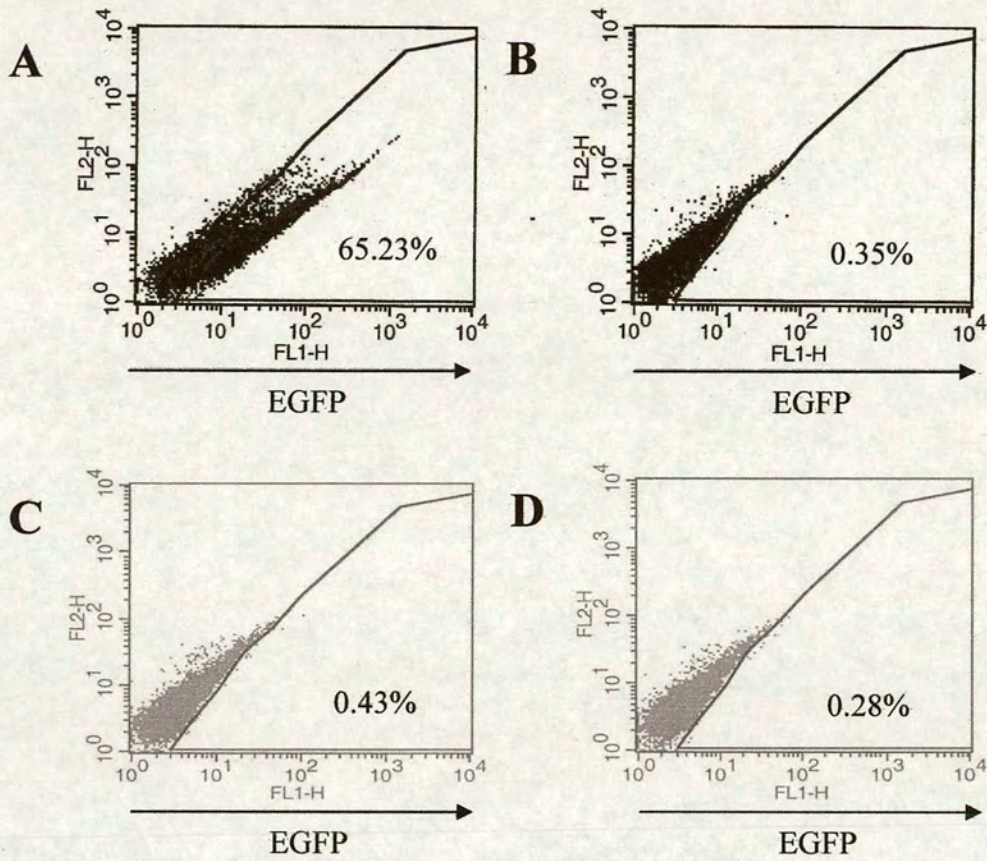

**Figure 33. Flow cytometric analysis of EGFP expression in Ainv15-AML1A cells**

Ainv15-AML1A (A, B) and Ainv15 (C, D) control cells were cultured with (A, C) or without doxycycline ( $1\mu\text{g}/\text{mL}$ ) (B, D) for 48 hours. Dead cells were stained with propidium iodide and gated out. Percentage of live EGFP positive cells is indicated. FL1-H channel detects EGFP whereas FL2-H channel detects autofluorescence. The data are representative of three independent experiments.

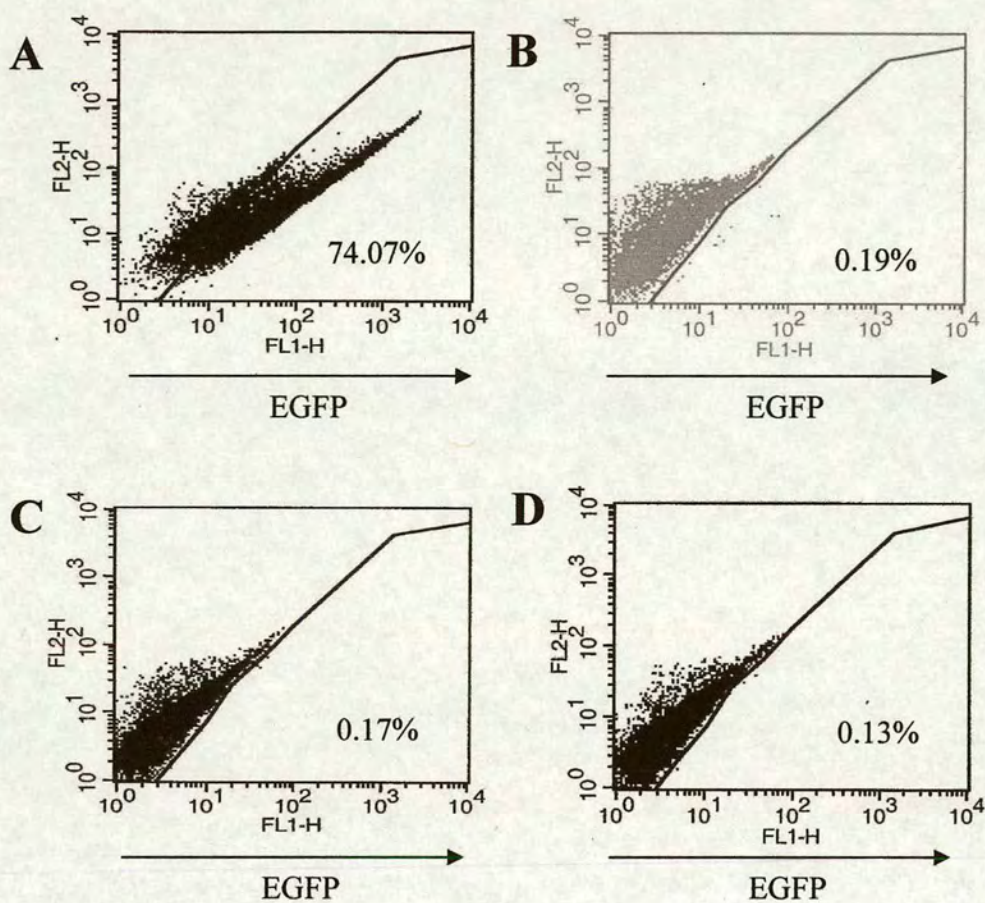

**Figure 34. Flow cytometric analysis of EGFP expression in Ainv15-AML1B cells**

Ainv15-AML1B (A, B) and Ainv15 (C, D) control cells were cultivated with (A, C) or without doxycycline ( $1\mu\text{g}/\text{mL}$ ) (B, D) for 48 hours. Dead cells were stained with propidium iodide and were gated out. Percentage of live EGFP positive cells is indicated. FL1-H channel detects EGFP whereas FL2-H channel detects autofluorescence. The data are representative of three independent experiments.

**A**

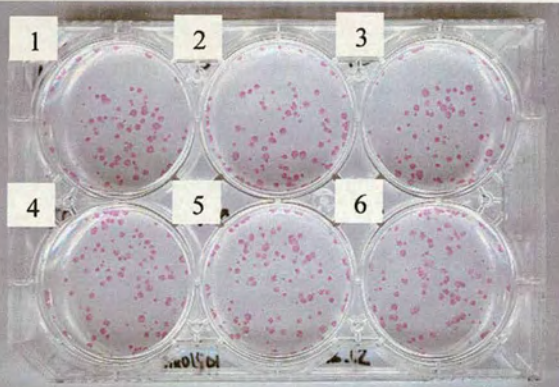

**B**

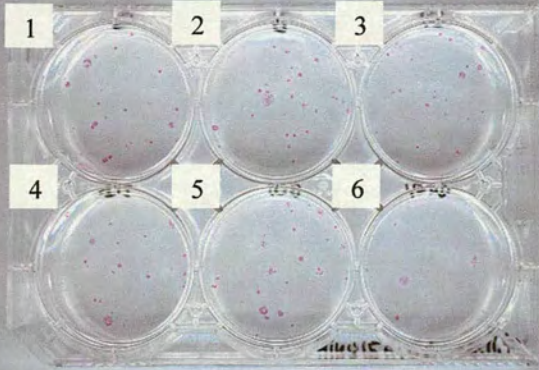

**C**

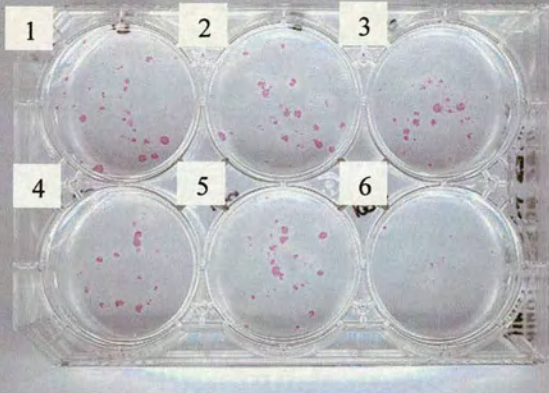

**Figure 35. Self-renewal abilities of the Ainv15-AML1A (and B) and Ainv15 cells cultivated at different concentrations of doxycycline**

Ainv15 (A), Ainv15-AML1A (B) and Ainv15-AML1B (C) cells were grown at different concentrations of doxycycline:

well 1 – no doxycycline

well 2 – 5 ng/mL doxycycline

well 3 – 10 ng/mL doxycycline

well 4 – 50 ng/mL doxycycline

well 5 – 100 ng/mL doxycycline

well 6 – 1000 ng/mL doxycycline

Alkaline phosphate activity of the cells was assayed on the tenth (A) or fourteenth (B, C) day of growth. The data presented are representative of three independent experiments.

(and B) (see Figure 35). The reduced proliferation abilities of Ainv15-AML1A (and B) cells might be caused by the following reasons: (i) the cells underwent more manipulation (including an extra-electroporation) *in vitro*, (ii) exogenous DNA inserted into the HPRT locus of Ainv15-AML1A (and B) cells might affect the cells growth abilities. Doxycycline induced overexpression of the transgenes affected the self-renewal abilities of the Ainv15-AML1A (and B) cells. The number and size of the Ainv15-AML1B alkaline positive colonies were highly reduced if the cells had been cultured with high concentration of doxycycline. Similar but more moderate effect was observed in Ainv15-AML1A cells in the presence of doxycycline. Doxycycline did not influence colony formation by the parental Ainv15 cells. However, since the Ainv15 cells growth capacity was much higher than that of the Ainv15-AML1A (and B) cells the moderate influence of doxycycline on the self-renewal ability of the Ainv15 cells could not be noticed in this experiment.

### **7.5. AML1 overexpression does not induce apoptosis in ES cells**

I then tested to see if the growth inhibitory effect of the AML1 overexpression on the undifferentiated ES cells is caused by the AML1-mediated apoptosis induction. To this end parental Ainv15 cells and derivative AML1 cDNA containing clones were co-stained using the fluorochrome-conjugated annexin V and 7-AAD (7-amino-actinomycin D). Annexin V is a phospholipid binding protein which preferentially interacts with phosphatidylserine in the presence of calcium cations. Phosphatidylserine is usually located in the inner leaflet of the plasma membrane but is translocated to the outer layer during early stages of apoptosis (reviewed by Vermes et al. 2000). Co-staining using a fluorochrome-conjugated annexin V and 7-AAD allows discriminating between live, early and late apoptotic and necrotic cells. 7-AAD penetrates cells with damaged plasma membrane (dying or dead cells) and binds DNA (Schmid et al. 1992). Neither annexin V nor 7-AAD can stain viable cells. Plasma membranes of early apoptotic cells is not penetratable for 7-AAD, but their inner leaflets contain phosphatidylserine, these cells are annexin V positive but 7-AAD negative. Membranes of late apoptotic, necrotic and dead cells are damaged that results in staining by both annexin V and 7-AAD.

Undifferentiated Ainv15, Ainv15-AML1A and B cells were incubated with or without doxycycline (final concentration 1 µg/mL) for three days. After that, the cells were co-stained using the PE (phycoerythrin) –conjugated annexin V and 7-AAD in the presence of calcium cations and analysed by flow cytometry (see Figures

36, 37 and 38). The experiment was repeated three times. Doxycycline induced AML1 overexpression did not increase apoptosis in the cells. Furthermore, FACS analysis showed that the most of the AML1/EGFP positive cells were viable.

#### **7.6. Influence of the AML1 overexpression on the ES cells hematopoietic differentiation *in vitro***

The original Ainv15 cells and AML1/EYFP containing derivative clones were assayed in haematopoietic differentiation assay (see Figures 39 and 40). ES cells hematopoietic differentiation *in vitro* is routinely performed in semi-solid medium (0.9% methylcellulose) with cytokines and growth factors (Wiles and Keller 1991). For this purpose, undifferentiated ES cells or pre-differentiated EBs were plated into bacterial low adhesive dishes with differentiation medium in absence of LIF. The medium is supplemented with erythropoietin, IL-6, IL-3, SCF, transferrin and insulin. However, semi-solid medium is unsuitable for doxycycline induction, since addition and removal of the doxycycline is not easily achievable. Therefore, a modified *in vitro* hematopoietic differentiation assay has been set up (see Figure 39) (Kyba et al. 2002; Kyba et al. 2003). The ES cells were predifferentiated in hanging drops for 2 days. The cells descend to the nadir of the drop by gravity and form an aggregate. As a result a single EB is formed per drop. Equal number of cells in each drop ensures relative uniformity of EBs. After formation of EBs for two days the hanging drops were washed out and EBs were cultured in a liquid medium in absence of LIF for 6 days. During the culture period the EBs were rotated to prevent them from adhering to the plates. Doxycycline (final concentration 1  $\mu\text{g/mL}$ ) was added to the liquid cultures on the fourth day, at the critical point when haemangioblasts are formed (Choi et al. 1998; Kyba et al. 2002; Kyba et al. 2003). After two days culture with doxycycline the EBs were harvested and disrupted with trypsin. The cells were plated into methylcellulose with cytokines and growth factors for hematopoietic differentiation. No doxycycline was added to the methylcellulose cultures. Haematopoietic colonies were scored on the fourteenth day of culture. The experiment has been repeated three times.

The EGFP expression was observed in both Ainv15-AML1A and Ainv15-AML1B EBs shortly after doxycycline addition (see Figure 39B). No green fluorescence was observed in any of the engineered cells without induction. All tested cell lines were capable of generating haematopoietic colonies (see Figures 39C and 40). All of them produced 30-50 hematopoietic colonies per  $10^4$  plated

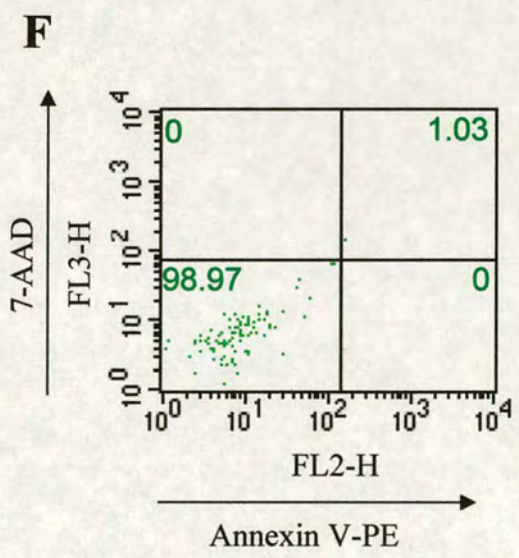
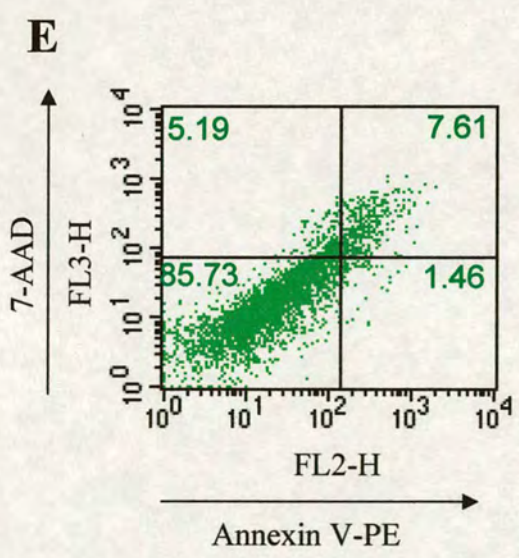
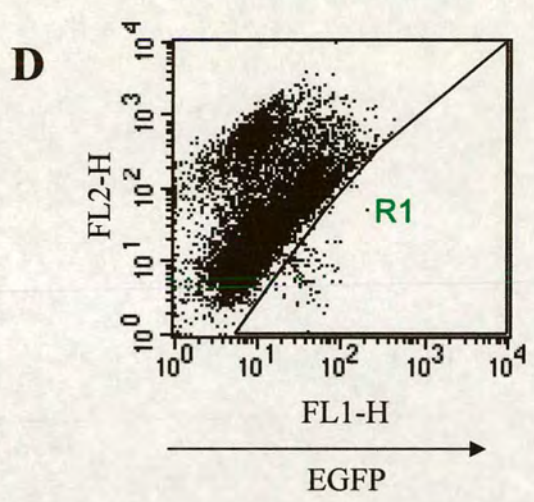
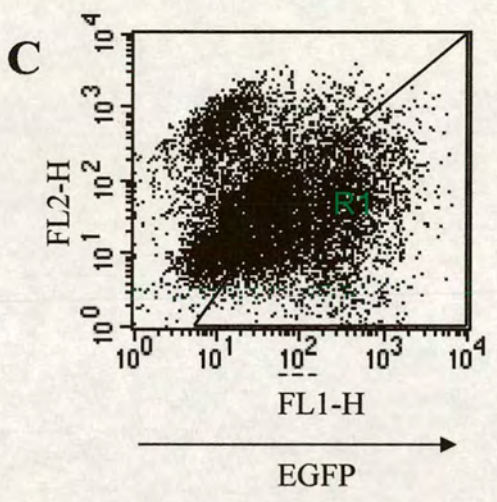
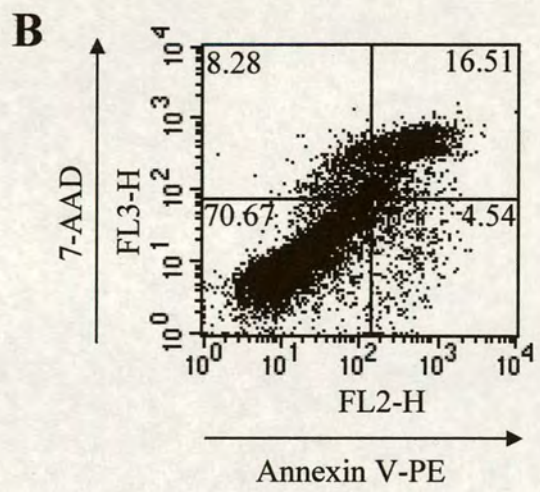
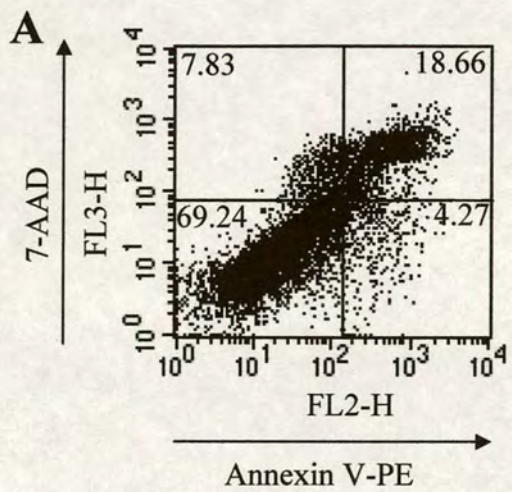

**Figure 36. AML1A overexpression does not induce apoptosis in undifferentiated Ainv15 cells**

Ainv15-AML1A cells were incubated with (A, C, E) or without doxycycline (B, D, F) for 3 days. Live, early and late apoptotic and necrotic cells were discriminated using the annexin V and 7-AAD co-staining (A, B). Live cells are double negative, early apoptotic cells are annexin V positive and 7-AAD negative, late apoptotic, dead and necrotic cells are double positive. EGFP positive cells were gated as R1 (C, D) and distribution of live, early and late apoptotic and necrotic cells in the green fluorescent cell population was determined (E, F). Percentage of stained cells is shown in each quadrant of dot plots A, B, E and F.

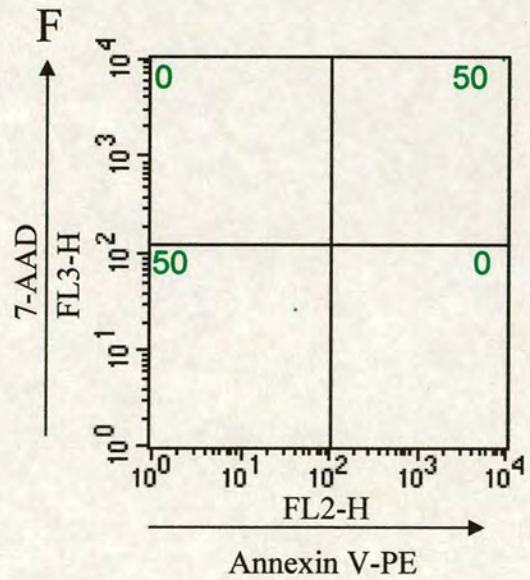
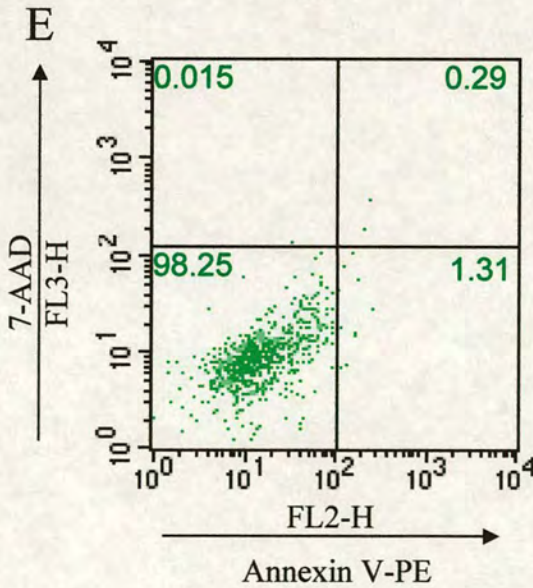
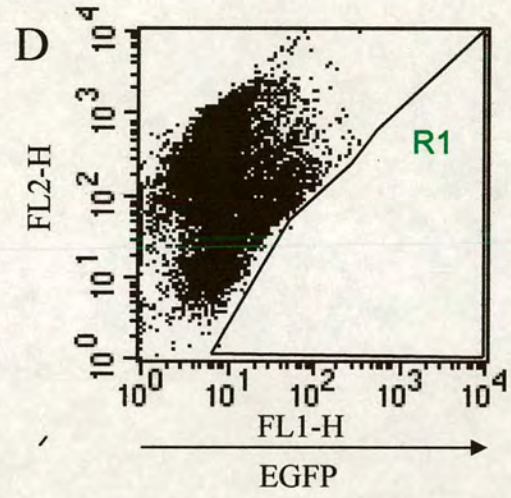
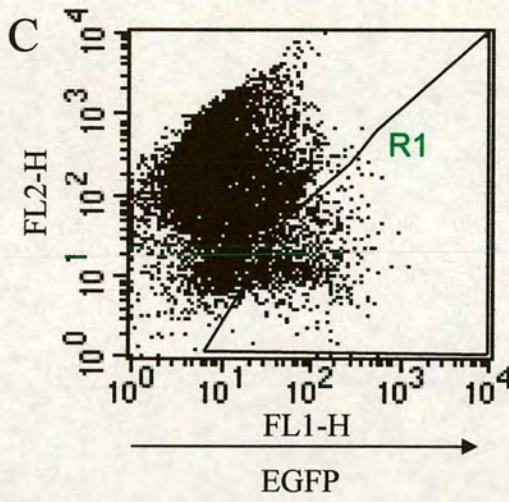
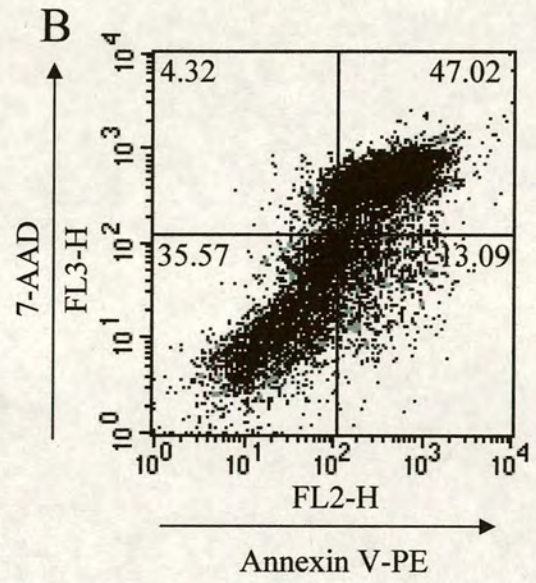
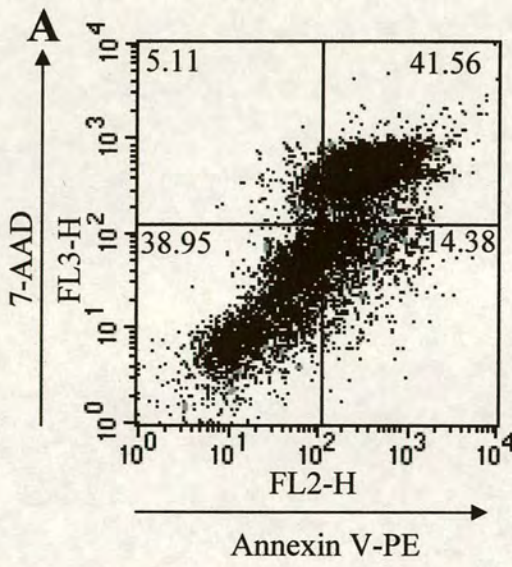

**Figure 37. AML1B overexpression does not induce apoptosis in undifferentiated Ainv15 cells**

All designations are as for Figure 36.

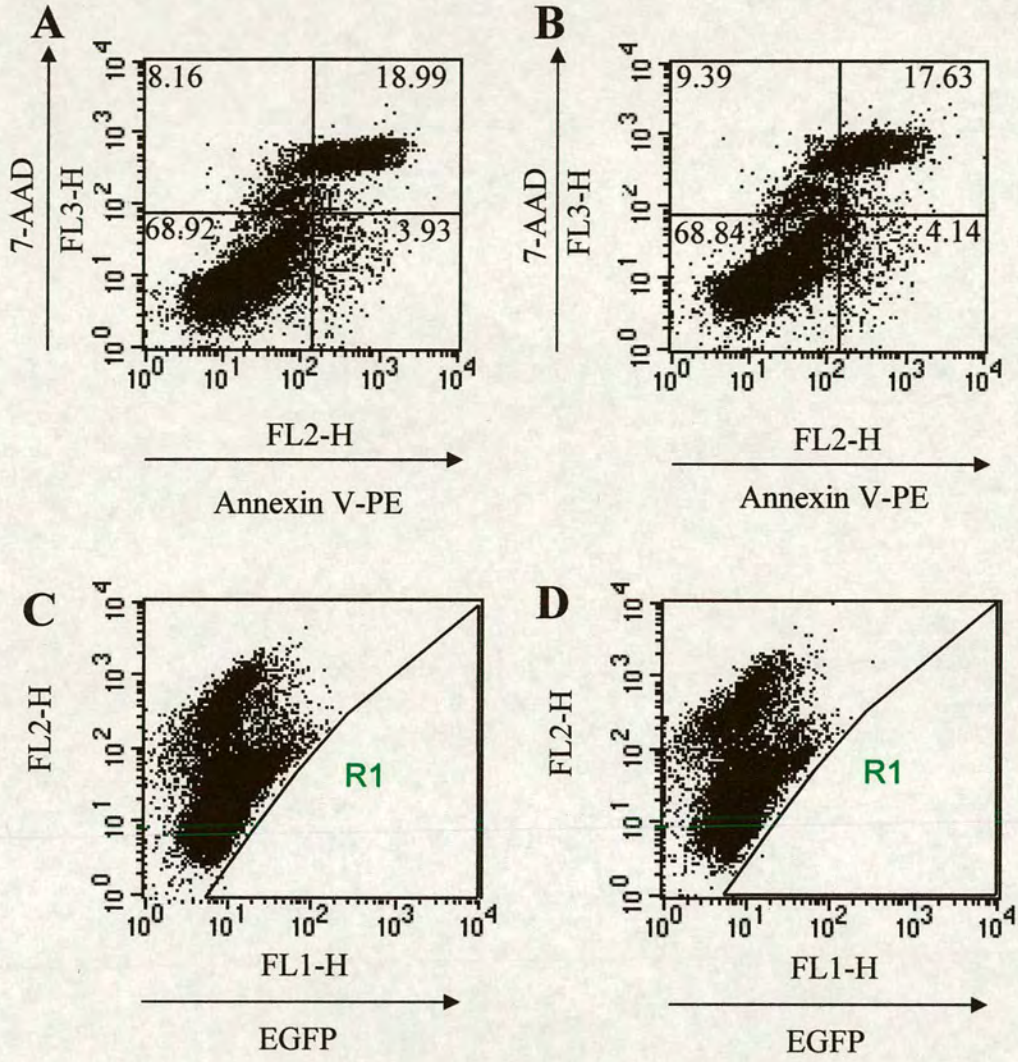

**Figure 38. Annexin V and 7-AAD co-staining of Ainv15 cells**

All designations are as for Figure 36, but green cells were not gated since the Ainv15 cells do not express EGFP.

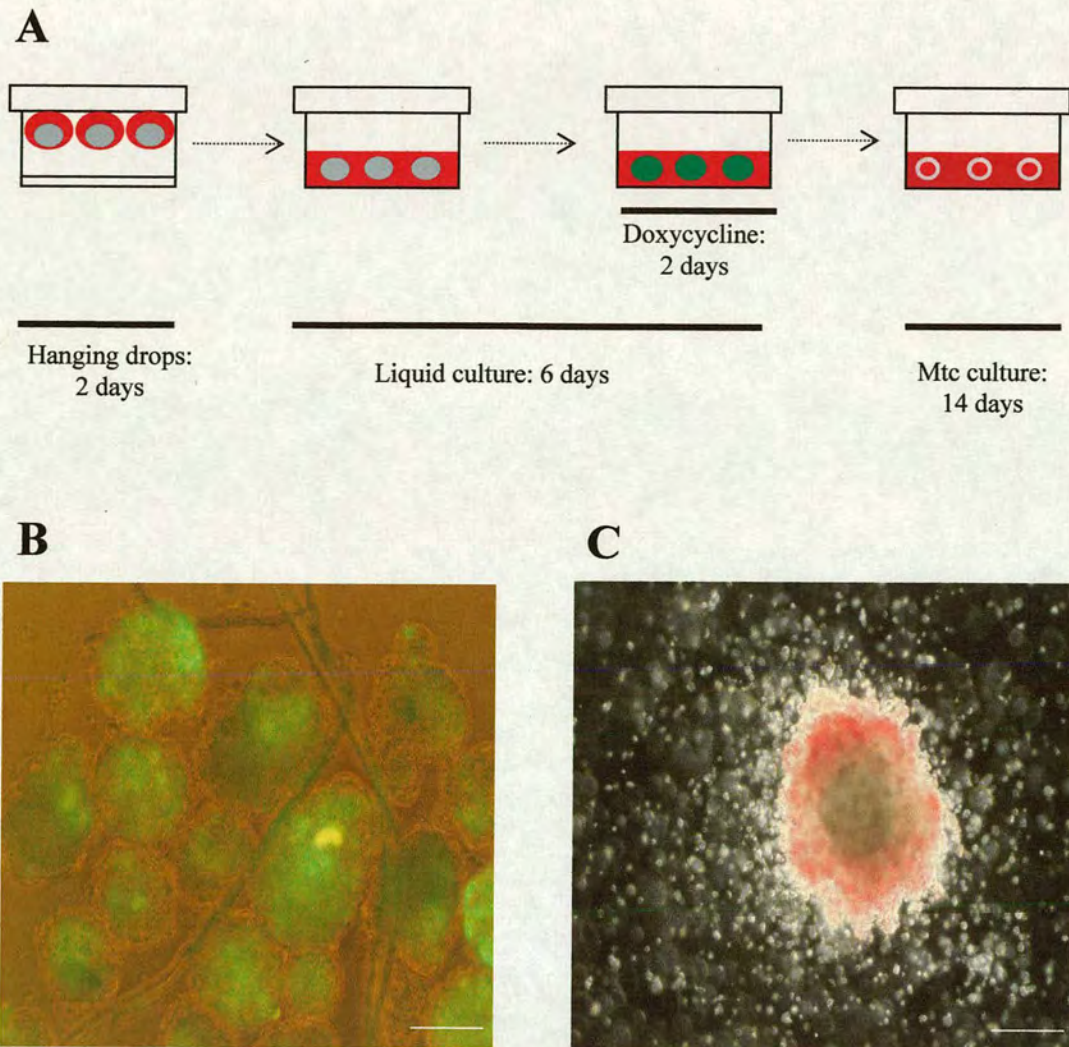

**Figure 39. Scheme of the Ainv15 cell hematopoietic differentiation *in vitro* assay**

- A.** Embryoid bodies were formed in hanging drops for two days. After that they were transferred in liquid culture and doxycycline ( $1 \mu\text{g/mL}$ ) was added on the fourth day. Two days later embryoid bodies were disrupted and the cells were plated into methylcellulose (mtc) containing medium with cytokines. No doxycycline was added into the methylcellulose containing medium.
- B.** A microphotograph of Ainv15-AML1A EBs incubated for two days with doxycycline. The scale bar represents  $250 \mu\text{m}$ .
- C.** A hematopoietic colony differentiated from the Ainv15-AML1A cells by the fourteenth day of the methylcellulose culture. The scale bar represents  $250 \mu\text{m}$ .

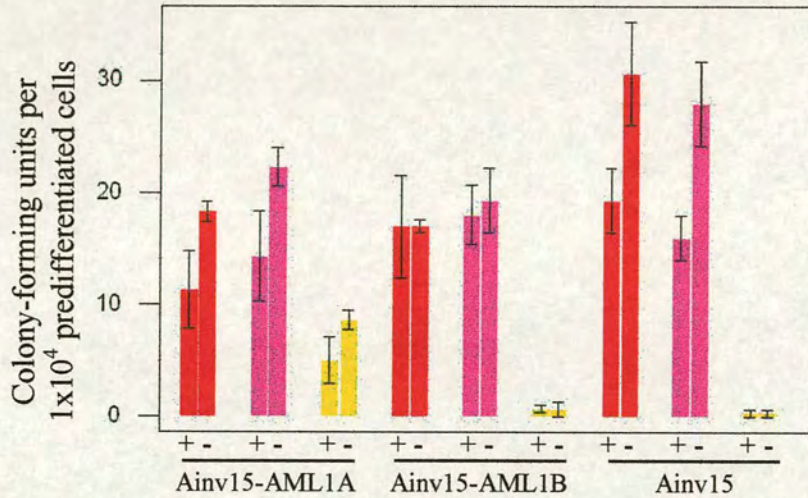

**Figure 40. Overexpression of AML1 isoforms does not significantly influence ES cell hematopoietic differentiation *in vitro*.**

AML1A (or B) individual isoforms were overexpressed in EBs presumably during differentiation of haemangioblast. After that the cells were plated into the methylcellulose medium with cytokines and growth factors. Hematopoietic colonies were scored on the fourteenth day of culture. “+” and “-“ designate whether doxycycline (1 µg/mL) has been added to pre-differentiated cells. Note that in control Ainv15 cells doxycycline inhibits haematopoietic colony formation. Different bar colours demonstrate individual types of hematopoietic colonies: erythroid (red), myeloid (purple) and endothelial (yellow). Each bar represents the mean value of three independent experiments (n=3). Error bars show standards errors.

predifferentiated cells. The total number of hematopoietic colonies did not vary significantly between cell lines. The number of Ainv15 and Ainv15-AML1A hematopoietic colonies was slightly decreased if doxycycline was added. However, no difference between induced and uninduced cultures is observed in AML1B overexpressing cells. Erythroid, myeloid and endothelial colonies were scored independently. The number of colonies of each type did not vary significantly between induced and non-induced cell populations. Therefore, I concluded that the AML1B overexpression might slightly induce hematopoietic differentiation that abandons doxycycline inhibition. However, this requires further elucidation.

## Chapter 8: DISCUSSION

AML1/Runx1 is a *Runt* domain containing transcriptional regulator which is necessary for the development of the definitive hematopoietic system. However, a conditional knockout mouse model has shown that AML1 is not crucial to maintain haematopoietic stem cells (HSCs) in adult bone marrow. The mouse survives upon induced deletion of AML1, only megakaryocytic and lymphoid differentiation are dramatically affected (Ichikawa et al. 2004). The human AML1 genomic locus spans 260 kb and contains 12 exons. It is regulated by two promoters: distal and proximal. Furthermore, this locus produces a number of splice isoforms of which short isoform which lacks the C-terminal transcription activation domain attracted special attention.

In this study I concentrated on two AML1 isoforms. The long AML1B isoform contains both the *Runt* (DNA binding) and transactivation (TA) domains while the AML1A short isoform encodes the TA domain only. I hypothesised that while the AML1B long isoform promotes haematopoietic differentiation the AML1A short isoform plays a dominant-inhibitory role and perhaps promotes self-renewal of immature haematopoietic progenitors. The main goal of this project was to generate model ES cell lines and mouse strains overexpressing the AML1 isoforms and to carry out initial assessment of the AML1 overexpression influence on the haematopoietic development.

First, an attempt to constitutively overexpress individual isoforms of AML1 in ES cells was undertaken. For this purpose, puromycin resistant episomal vectors which can replicate autonomously in eukaryotic cells harbouring polyoma large T antigen were used. The E14/T ES cell line constructed previously by Dr. Ian Chambers was used for this purpose (Aubert et al. 2002; Chambers et al. 2003). I found that these cells supertransfected with control vectors with or without an EGFP insert gave a large number of puromycin resistant undifferentiated colonies (see Figure 9). However, AML1A and AML1B supertransfected cells gave few or no colonies, respectively, indicating that AML1 has some cytotoxic effect in ES cells. The absence of puromycin resistant colonies cannot be caused by inhibitory effect of AML1 on proper function of IRES which drives expression of Puro<sup>r</sup>, since the same design of the vector was successfully used for initiation of the EGFP translation in bi-cistronic vectors (see Figures 33 and 34). These data contrasted a previously published study which reported that overexpression of AML1 isoforms in ES cells

does not affect their growth (Aziz-Aloya et al. 1998). In this paper ES cells were stably transfected with AML1 cDNAs driven by a PGK promoter. Following drug selection resistant colonies were obtained and expression of isoforms was confirmed by Northern and Western blotting. However in my experiments AML1 is likely to be expressed at much higher level since (i) a strong composite CAG promoter was used and (ii) high number of copies of the episome which is not influenced by chromatin context due to lack of integration into genome is maintained in the cells. Indeed, episomal vectors which contain the CAG promoter give 10 times higher level of cDNA expression than analogous episomal vectors with the PGK promoter in ES cells (Niwa et al. 1998). In line with that it has been shown that the functional efficiency of Cre recombinase driven by the CAG promoter in recombination experiments was 3-4 times higher than in case when PGK promoter was used (Araki et al. 1997). Furthermore, it has been assessed previously that about 5-10 copies of the episomal vector per cell is normally maintained by supertransfected cells (Gassmann et al. 1995). However, this number may be underestimated due to low efficiency of recovery of episomal vectors during the isolation procedure. It is likely that the number of copies of the AML1 expressing transgene in the previous study was not much higher than one copy due to specific conditions used for ES cell electroporation (Aziz-Aloya et al. 1998). Therefore, the level of AML1 expression might not be sufficient to inhibit ES cell growth. Therefore, it is likely that ES cells can tolerate relatively low levels of overexpressed AML1 but are inhibited by high levels of AML1 expression. Therefore, it would be useful to use regulatable AML1 expression system to analyse biological effects of this gene. This became next aim of this research.

Over the last decade a few systems have been published which allow regulatable expression of genes of interest (Wang et al. 1994; Gossen et al. 1995; No et al. 1996). I choose the most advanced Tet-On inducible gene expression system to express AML1 in an inducible manner. The basic system consists of the chimaeric transcriptional transactivator rtTA2<sup>S</sup>-M2 which binds TRP upon the doxycycline addition. This system is tightly regulated. It shows no background expression of the reporter gene in the absence of doxycycline which is upregulated up to 4-5 orders of magnitude upon doxycycline induction. Furthermore, working concentrations of doxycycline are below its cytotoxic level and the components of the system do not interfere with cellular metabolic pathways.

In order to overexpress AML1 isoforms in haematopoietic progenitors in a regulatable manner *in vivo* the Tet-On double transgenic system was designed. rtTA2<sup>S</sup>-M2 (further referred as rtTA) was targeted into the AML1 gene locus and TRP driving individual isoforms of AML1 were planned to be randomly integrated into genome. It was expected that fine tuning of the AML1 expression can be achieved by variation of the doxycycline concentration.

The first stage was generation of the regulatory ES cell line and the mouse strain. Unpublished data from our and other laboratories suggest that both proximal and distal promoters are active in hematopoietic progenitors though it is conceivable that the distal promoter turns on upon the proximal promoter activation (Fujita et al. 2001). Therefore, I supposed that the proximal promoter would be adequate to drive AML1 cDNA expression in early hematopoietic progenitors. Therefore, the rtTA gene expression cassette was targeted into the exon 3 of AML1 which is the first coding exon in proximal transcripts. The cloning strategy was designed so that the rtTA gene expression cassette was inserted between the AML1 fourth and fifth coding nucleotide in-frame with the initiator ATG codon. The proximal 5' UTR and rtTA transgene only can be transcribed from the proximal promoter since transcription is designed to be terminated by exogenous SV40pA and SPA signal sequences targeted downstream the rtTA transgene. Therefore, the rtTA targeted AML1 locus cannot produce functional proximal transcripts. Translation of rtTA will presumably be initiated by endogenous IRES located within the proximal 5' UTR (Pozner et al. 2000). Transcription from the distal promoter is also terminated by downstream exogenous signals following rtTA sequence. Aberrant distal transcript contains the exons 1, 2 and relevant introns. The last intron of the distal transcript encodes proximal promoter, proximal 5' UTR and the rtTA transgene. A splice acceptor site of the intron is located within the coding part of exon 3 downstream the exogenous polyadenylation signals and is not transcribed. Therefore, rtTA is unlikely to be spliced out from distal transcripts. rtTA encoded by the aberrant distal transcript may be translated via the IRES initiated mechanism. However, the real fate of the aberrant distal transcripts in a cell requires further investigations. Taken together, no functional AML1 transcripts are expected to be transcribed from the rtTA targeted allele unless there is read through the SV40pA and SPA polyadenylation signals located downstream of the rtTA transgene. In contrast, at least proximal transcripts should encode functional rtTA.

rtTA was successfully targeted into the AML1 locus using standard gene targeting procedure in ES cells. The ES cells were injected into the blastocyst and chimaeric mice were generated. Germ line transmission of the mutant allele was further achieved by crossing these chimaeric mice with wild type mice. rtTA expression was studied in *in vitro* differentiating ES cells by RT-PCR (see Figure 18). The AML1 gene expression was analysed using primers annealing to both distal and proximal transcripts. The amplified region was designed to be common for major proximal and distal transcripts. However, since distal transcripts are expressed at very low levels during the first 8 days of ES cells differentiation (Fujita et al. 2001), their expression may not be taken into account in this analysis. Both rtTA and AML1 had very similar dynamics of expression that further confirmed correct targeting of the AML1 locus with rtTA.

The dynamics of rtTA expression in targeted ES cells suggested that it can be used to activate the TRP expression in an AML1-specific fashion. I generated two series of AML1 responsive constructs to use in this system: (i) luciferase responsive constructs for transient transfection (see Figure 19) and (ii) EYFP responsive constructs for stable transfection (see Figure 23). The AML1/rtTA regulatory ES cells were transiently transfected with luciferase responsive constructs in order to test functionality of rtTA. The reporter activity was determined after 56 hours of incubation with doxycycline. However, no induction of the firefly luciferase expression was detected despite testing different conditions of transfection and culture. This cannot be explained by failure of DNA to penetrate the cells, since high expression level of cotransfected *Renilla* luciferase could readily be detected. To check if the responsive constructs are functional I used B8 ES cell line with integrated functional rtTA generated by Dawn Fisher and Dr. Andrew Smith. In these cells the rtTA transgene is targeted into the house-keeping HPRT gene locus. Using transient transfection of B8 ES cells with luciferase responsive constructs I demonstrated that the firefly luciferase expression was induced 40 fold by doxycycline. Therefore, the reason why these responsive constructs were not inducible in AML1/rtTA regulatory ES cells was associated most likely with low levels of AML1/rtTA expression in undifferentiated ES cells. However, although I have shown by RT-PCR that dynamics of rtTA expression follows endogenous AML1 expression it cannot be entirely ruled out that rtTA protein is unfunctional. The analysis of the problem would be very laborious and time-consuming and therefore I started to look for an alternative system. By that time the Tet-On/HPRT

gene expression system was reported (Kyba et al. 2002; Kyba et al. 2003) and I decided to use it to overexpress AML1 isoforms in a regulatable fashion.

Ainv15 ES cells which have been used in these publications were provided to us by the authors. These cells contain functional rtTA targeted in a ubiquitously expressed ROSA26 locus. They also contain a homing site for the single *loxP* site targeting into a house-keeping HPRT locus. A specially modified pLox plasmid in which a cDNA of interest can be cloned also contains a *loxP* site. If the pLox and Cre-expressing plasmids are cotransfected recombination between chromosomal and plasmid *loxP* sites occurs which results in integration of cDNA into the HPRT homing site of Ainv15 cells. Although Cre-mediated excision is more favourable than Cre-mediated integration rare cells with integrated transgene can effectively be selected in presence of G418 since the correct integration results in generation of a functional Neo<sup>r</sup> gene. Therefore, no screening is necessary.

However, during detailed analysis of the system I found an additional feature of these cells that is not described in the literature but can play an important role in high efficiency of integration of cDNA into the HPRT homing site in genome. Before designing strategy of molecular cloning I sequenced all functional regions in the pLox plasmid and found a two nucleotide insertion in the *loxP* site (see Figure 30). Further literature search has shown that this mutant *loxP* site was previously used to bias the *loxP* recombination event towards integration (Fukushige and Sauer 1992). This had not been described in the papers where the Tet-On/HPRT system generation was reported (Kyba et al. 2002; Kyba et al. 2003). Furthermore, contact with one of the authors showed that they were not aware of this feature of the system. In fact the original system was generated by another group (Wutz et al. 2002). Therefore, it may be that the efficiency of integration of cDNA is defined not only by restoration of the Neo<sup>r</sup> transgene in correctly recombined cells but also by use of the mutant *loxP* site which favours integration over excision. This is in line with experience in our laboratory: an attempt to use a similar approach to integrate a sequence via Cre-mediated recombination using a wild type *loxP* sites failed.

The analysis of the pLox plasmid has shown presence of an extra ATG codon. This codon has no Kozak sequence but still can be functionally active (Ho et al. 1995; Tucker et al. 2001). If so it can inhibit the downstream ATG codon initiating the cDNA translation. Therefore, before cloning the cDNA I mutated the upstream ATG site in the plasmid.

In order to monitor upregulation of the AML1 cDNA the IRES EGFP reporter unit was cloned into the pLox plasmid. Therefore, transgene expression can be tracked in live cells. This also allows flow sorting of AML1 expressing cells. The doxycycline induced EGFP expression was observed in all targeted Ainv15 cells which were selected in presence of G418. Thus, high efficiency of the single *loxP* targeting strategy has been readily observed. In order to test the putative cytotoxic effect of overexpression of AML1 isoforms, the cells were cultured at increasing concentrations of doxycycline. The alkaline phosphatase activity of colonies was assayed what allowed identification of undifferentiated colonies. Similarly to experiments with episomal vectors, overexpression of the long isoform AML1B was more toxic than overexpression of the short isoform AML1A. However the cytotoxic effect was observed only at high concentrations of doxycycline.

It has been shown that AML1 may be involved in regulation of senescence and/or apoptosis. AML1 overexpression in mouse embryonic fibroblasts induces senescence (Linggi et al. 2002). The AML1-mediated transcriptional activation of the p14<sup>ARF</sup> promoter has been demonstrated in human HeLa cells (Linggi et al. 2002). p14<sup>ARF</sup> is an important tumour suppressor gene controlling the function of p53 which is an important regulator of cell growth and apoptosis. Loss of either p14<sup>ARF</sup> or p53 function prevents growth arrest and/or apoptosis (reviewed by Hiebert et al. 2003). In order to check if overexpression of AML1 induces apoptosis I co-stained cells with Annexin V and 7-AAD upon induction with doxycycline during three days. FACS analysis has shown no difference between induced and uninduced cell populations. Moreover, the most part of EGFP positive cells was alive. Therefore, it is not likely that AML1 overexpression induces apoptosis in ES cells although its involvement in the senescence or cell cycle progression regulation is still conceivable.

In order to test the influence of AML1 expression haematopoietic development *in vitro* differentiation of Ainv15-AML1 cells was undertaken. The normally used ES cell differentiation protocol is not suitable for doxycycline induction due to technical reasons (addition and removal of an inducer are not easily achievable in the semi-solid medium). Therefore, a modified protocol which allows short term induction was used. To this end the ES cells were initially plated in hanging drops to form embryoid bodies. Following that the EBs were plated in liquid differentiation culture in a shaking incubator to avoid adherence to the plate. Use of

liquid culture allowed precise exogenous AML1 induction with doxycycline during putative differentiation of the haemangioblast (Choi et al. 1998; Kyba et al. 2002; Kyba et al. 2003). After that the EBs were plated in the haematopoietic methylcellulose differentiation medium. The AML1A overexpression does not influence the hematopoietic differentiation *in vitro* whereas the number of hematopoietic colonies appeared to be slightly elevated upon the AML1B induction. Further research is necessary to investigate this issue. It may be that the effect can be achieved if AML1 overexpression is induced at later stages of EB differentiation or during a more prolonged period of time. It also could be that only certain levels of AML1 expression can cause deviation in haematopoietic differentiation. Such examples have been reported in the literature previously (Niwa et al. 2000).

In addition to the aforementioned analysis a binary AML1 inducible system has been generated and undergone initial analysis. The AML1/rtTA regulatory mice were generated from targeted AML1/rtTA regulatory ES cells. The responsive AML1A and AML1B mice have been generated by pronuclear microinjection in collaboration with the Dr. Dimitris Kioussis laboratory (NIMR, Lodon). For this purpose, an EYFP series of the AML1 bi-directional responsive constructs was used (see Figure 23). Therefore, AML1 induction can be monitored by expression of EYFP reporter in live cells. Several transgenic mouse lines were obtained by the pronuclear microinjections. These mice were intercrossed with the CD2-rtTA regulatory mice. Adding doxycycline in food induced EYFP expression in thymocytes of the double transgenic mice as expected since CD2 promoter drives expression in thymocytes. The double transgenic mice will be used in collaboration with D. Kioussis to investigate the role of AML1 role in T-cells development and differentiation.

The use of AML1/rtTA regulatory mice in combination with responsive AML1/EYFP mice in future will allow analysis of AML1 overexpression in haematopoietic stem and progenitor cells.

The data obtained in the thesis do not support the original hypothesis stating that the AML1A short isoform may promote the hematopoietic progenitors self-renewal whereas the AML1B long isoform may promote their differentiation. Although the number of hematopoietic colonies was slightly elevated upon the AML1B long isoform overexpression *in vitro* the underlying mechanism (which may be promoting either self-renewal or differentiation) requires of further investigation.

This may include analysis of early hematopoietic progenitors *in vitro* in order to determine the exact stage when the difference between induced and uninduced populations appears. Furthermore, transplantation of Ainv15 cells and its derivatives into lethally irradiated recipients may be done in order to investigate the role of the AML1 isoforms in hematopoiesis *in vivo*.

## REFERENCES

- Albanese, C., A. T. Reutens, et al. (2000). "Sustained mammary gland-directed, ponasterone A-inducible expression in transgenic mice." *Faseb J* **14**(7): 877-84.
- Alitalo, R. (1990). "Induced differentiation of K562 leukemia cells: a model for studies of gene expression in early megakaryoblasts." *Leuk Res* **14**(6): 501-14.
- Araki, K., T. Imaizumi, et al. (1997). "Efficiency of recombination by Cre transient expression in embryonic stem cells: comparison of various promoters." *J Biochem (Tokyo)* **122**(5): 977-82.
- Aronson, B. D., A. L. Fisher, et al. (1997). "Groucho-dependent and -independent repression activities of Runt domain proteins." *Mol Cell Biol* **17**(9): 5581-7.
- Ashfield, R., A. J. Patel, et al. (1994). "MAZ-dependent termination between closely spaced human complement genes." *Embo J* **13**(23): 5656-67.
- Asou, N. (2003). "The role of a Runt domain transcription factor AML1/RUNX1 in leukemogenesis and its clinical implications." *Crit Rev Oncol Hematol* **45**(2): 129-50.
- Aubert, J., H. Dunstan, et al. (2002). "Functional gene screening in embryonic stem cells implicates Wnt antagonism in neural differentiation." *Nat Biotechnol* **20**(12): 1240-5.
- Aziz-Aloya, R. B., D. Levanon, et al. (1998). "Expression of AML1-d, a short human AML1 isoform, in embryonic stem cells suppresses in vivo tumor growth and differentiation." *Cell Death Differ* **5**(9): 765-73.
- Bae, S. C., E. Ogawa, et al. (1994). "PEBP2 alpha B/mouse AML1 consists of multiple isoforms that possess differential transactivation potentials." *Mol Cell Biol* **14**(5): 3242-52.
- Bae, S. C., Y. Yamaguchi-Iwai, et al. (1993). "Isolation of PEBP2 alpha B cDNA representing the mouse homolog of human acute myeloid leukemia gene, AML1." *Oncogene* **8**(3): 809-14.
- Baron, U., S. Freundlieb, et al. (1995). "Co-regulation of two gene activities by tetracycline via a bidirectional promoter." *Nucleic Acids Res* **23**(17): 3605-6.
- Baron, U., M. Gossen, et al. (1997). "Tetracycline-controlled transcription in eukaryotes: novel transactivators with graded transactivation potential." *Nucleic Acids Res* **25**(14): 2723-9.
- Berardi, M. J., C. Sun, et al. (1999). "The Ig fold of the core binding factor alpha Runt domain is a member of a family of structurally and functionally related Ig-fold DNA-binding domains." *Structure Fold Des* **7**(10): 1247-56.

- Berstine, E. G., M. L. Hooper, et al. (1973). "Alkaline phosphatase activity in mouse teratoma." Proc Natl Acad Sci U S A **70**(12): 3899-903.
- Bitter, M. A., M. M. Le Beau, et al. (1987). "Associations between morphology, karyotype, and clinical features in myeloid leukemias." Hum Pathol **18**(3): 211-25.
- Blobel, G. A. (2000). "CREB-binding protein and p300: molecular integrators of hematopoietic transcription." Blood **95**(3): 745-55.
- Bork, P., L. Holm, et al. (1994). "The immunoglobulin fold. Structural classification, sequence patterns and common core." J Mol Biol **242**(4): 309-20.
- Borrow, J., V. P. Stanton, Jr., et al. (1996). "The translocation t(8;16)(p11;p13) of acute myeloid leukaemia fuses a putative acetyltransferase to the CREB-binding protein." Nat Genet **14**(1): 33-41.
- Bradley, A., M. Evans, et al. (1984). "Formation of germ-line chimaeras from embryo-derived teratocarcinoma cell lines." Nature **309**(5965): 255-6.
- Breier, G., F. Breviario, et al. (1996). "Molecular cloning and expression of murine vascular endothelial-cadherin in early stage development of cardiovascular system." Blood **87**(2): 630-41.
- Bristow, C. A. and P. Shore (2003). "Transcriptional regulation of the human MIP-1alpha promoter by RUNX1 and MOZ." Nucleic Acids Res **31**(11): 2735-44.
- Brocard, J., X. Warot, et al. (1997). "Spatio-temporally controlled site-specific somatic mutagenesis in the mouse." Proc Natl Acad Sci U S A **94**(26): 14559-63.
- Bronstein, I., J. Fortin, et al. (1994). "Chemiluminescent and bioluminescent reporter gene assays." Anal Biochem **219**(2): 169-81.
- Bruhn, L., A. Munneryn, et al. (1997). "ALY, a context-dependent coactivator of LEF-1 and AML-1, is required for TCRalpha enhancer function." Genes Dev **11**(5): 640-53.
- Burcin, M. M., G. Schiedner, et al. (1999). "Adenovirus-mediated regulable target gene expression in vivo." Proc Natl Acad Sci U S A **96**(2): 355-60.
- Buszczak, M. and W. A. Seagraves (1998). "Drosophila metamorphosis: the only way is USP?" Curr Biol **8**(24): R879-82.
- Castilla, L. H., C. Wijmenga, et al. (1996). "Failure of embryonic hematopoiesis and lethal hemorrhages in mouse embryos heterozygous for a knocked-in leukemia gene CBFB-MYH11." Cell **87**(4): 687-96.
- Chambers, I., D. Colby, et al. (2003). "Functional expression cloning of Nanog, a pluripotency sustaining factor in embryonic stem cells." Cell **113**(5): 643-55.
- Champagne, N., N. Pelletier, et al. (2001). "The monocytic leukemia zinc finger protein MOZ is a histone acetyltransferase." Oncogene **20**(3): 404-9.

- Chang, K. C., E. Hansen, et al. (1991). "Molecular and functional analysis of the virus- and interferon-inducible human MxA promoter." Arch Virol **117**(1-2): 1-15.
- Chen, G. and A. J. Courey (2000). "Groucho/TLE family proteins and transcriptional repression." Gene **249**(1-2): 1-16.
- Choi, K., M. Kennedy, et al. (1998). "A common precursor for hematopoietic and endothelial cells." Development **125**(4): 725-32.
- Chrivia, J. C., R. P. Kwok, et al. (1993). "Phosphorylated CREB binds specifically to the nuclear protein CBP." Nature **365**(6449): 855-9.
- Corsetti, M. T. and F. Calabi (1997). "Lineage- and stage-specific expression of runt box polypeptides in primitive and definitive hematopoiesis." Blood **89**(7): 2359-68.
- de Bruijn, M. F., N. A. Speck, et al. (2000). "Definitive hematopoietic stem cells first develop within the major arterial regions of the mouse embryo." Embo J **19**(11): 2465-74.
- Delafontaine, P., L. Ku, et al. (1996). "Insulin-like growth factor 1 binding protein 3 synthesis by aortic endothelial cells is a function of cell density." Biochem Biophys Res Commun **222**(2): 478-82.
- Delafontaine, P., Y. H. Song, et al. (2004). "Expression, regulation, and function of IGF-1, IGF-1R, and IGF-1 binding proteins in blood vessels." Arterioscler Thromb Vasc Biol **24**(3): 435-44.
- Delassus, S. and A. Cumano (1996). "Circulation of hematopoietic progenitors in the mouse embryo." Immunity **4**(1): 97-106.
- Derynck, R. and Y. E. Zhang (2003). "Smad-dependent and Smad-independent pathways in TGF-beta family signalling." Nature **425**(6958): 577-84.
- Doetschman, T. C., H. Eistetter, et al. (1985). "The in vitro development of blastocyst-derived embryonic stem cell lines: formation of visceral yolk sac, blood islands and myocardium." J Embryol Exp Morphol **87**: 27-45.
- Domen, J. and I. L. Weissman (1999). "Self-renewal, differentiation or death: regulation and manipulation of hematopoietic stem cell fate." Mol Med Today **5**(5): 201-8.
- Dudley, E. C., H. T. Petrie, et al. (1994). "T cell receptor beta chain gene rearrangement and selection during thymocyte development in adult mice." Immunity **1**(2): 83-93.
- Durst, K. L., B. Lutterbach, et al. (2003). "The inv(16) fusion protein associates with corepressors via a smooth muscle myosin heavy-chain domain." Mol Cell Biol **23**(2): 607-19.
- Dzierzak, E. and A. Medvinsky (1995). "Mouse embryonic hematopoiesis." Trends Genet **11**(9): 359-66.

- Eichmann, A., C. Corbel, et al. (1997). "Ligand-dependent development of the endothelial and hemopoietic lineages from embryonic mesodermal cells expressing vascular endothelial growth factor receptor 2." Proc Natl Acad Sci U S A **94**(10): 5141-6.
- Elagib, K. E., F. K. Racke, et al. (2003). "RUNX1 and GATA-1 coexpression and cooperation in megakaryocytic differentiation." Blood **101**(11): 4333-41.
- Erman, B., M. Cortes, et al. (1998). "ETS-core binding factor: a common composite motif in antigen receptor gene enhancers." Mol Cell Biol **18**(3): 1322-30.
- Evans, M. J. and M. H. Kaufman (1981). "Establishment in culture of pluripotential cells from mouse embryos." Nature **292**(5819): 154-6.
- Finkelman, F. D., A. Svetic, et al. (1991). "Regulation by interferon alpha of immunoglobulin isotype selection and lymphokine production in mice." J Exp Med **174**(5): 1179-88.
- Franklin, S. L., R. J. Ferry, Jr., et al. (2003). "Rapid insulin-like growth factor (IGF)-independent effects of IGF binding protein-3 on endothelial cell survival." J Clin Endocrinol Metab **88**(2): 900-7.
- Fraser, S. T., M. Ogawa, et al. (2002). "Embryonic stem cell differentiation as a model to study hematopoietic and endothelial cell development." Methods Mol Biol **185**: 71-81.
- Fraser, S. T., M. Ogawa, et al. (2003). "Putative intermediate precursor between hematogenic endothelial cells and blood cells in the developing embryo." Dev Growth Differ **45**(1): 63-75.
- Fraser, S. T., J. Yamashita, et al. (2003). "In vitro differentiation of mouse embryonic stem cells: hematopoietic and vascular cell types." Methods Enzymol **365**: 59-72.
- Freundlieb, S., U. Baron, et al. (1997). "Use of tetracycline-controlled gene expression systems to study mammalian cell cycle." Methods Enzymol **283**: 159-73.
- Freundlieb, S., C. Schirra-Muller, et al. (1999). "A tetracycline controlled activation/repression system with increased potential for gene transfer into mammalian cells." J Gene Med **1**(1): 4-12.
- Fujimura, F. K., P. L. Deininger, et al. (1981). "Mutation near the polyoma DNA replication origin permits productive infection of F9 embryonal carcinoma cells." Cell **23**(3): 809-14.
- Fujita, Y., M. Nishimura, et al. (2001). "Identification of an alternatively spliced form of the mouse AML1/RUNX1 gene transcript AML1c and its expression in early hematopoietic development." Biochem Biophys Res Commun **281**(5): 1248-55.

- Fukushige, S. and B. Sauer (1992). "Genomic targeting with a positive-selection lox integration vector allows highly reproducible gene expression in mammalian cells." Proc Natl Acad Sci U S A **89**(17): 7905-9.
- Gamou, T., E. Kitamura, et al. (1998). "The partner gene of AML1 in t(16;21) myeloid malignancies is a novel member of the MTG8(ETO) family." Blood **91**(11): 4028-37.
- Garcia-Porrero, J. A., I. E. Godin, et al. (1995). "Potential intraembryonic hemogenic sites at pre-liver stages in the mouse." Anat Embryol (Berl) **192**(5): 425-35.
- Gassmann, M., G. Donoho, et al. (1995). "Maintenance of an extrachromosomal plasmid vector in mouse embryonic stem cells." Proc Natl Acad Sci U S A **92**(5): 1292-6.
- Gearing, D. P., J. A. King, et al. (1988). "Complete sequence of murine myeloid leukaemia inhibitory factor (LIF)." Nucleic Acids Res **16**(20): 9857.
- Ghozi, M. C., Y. Bernstein, et al. (1996). "Expression of the human acute myeloid leukemia gene AML1 is regulated by two promoter regions." Proc Natl Acad Sci U S A **93**(5): 1935-40.
- Giese, K., C. Kingsley, et al. (1995). "Assembly and function of a TCR alpha enhancer complex is dependent on LEF-1-induced DNA bending and multiple protein-protein interactions." Genes Dev **9**(8): 995-1008.
- Gill, J., M. Malin, et al. (2003). "Thymic generation and regeneration." Immunol Rev **195**: 28-50.
- Giniger, E., S. M. Varnum, et al. (1985). "Specific DNA binding of GAL4, a positive regulatory protein of yeast." Cell **40**(4): 767-74.
- Godfrey, D. I., J. Kennedy, et al. (1994). "Onset of TCR-beta gene rearrangement and role of TCR-beta expression during CD3-CD4-CD8- thymocyte differentiation." J Immunol **152**(10): 4783-92.
- Godfrey, D. I., J. Kennedy, et al. (1993). "A developmental pathway involving four phenotypically and functionally distinct subsets of CD3-CD4-CD8- triple-negative adult mouse thymocytes defined by CD44 and CD25 expression." J Immunol **150**(10): 4244-52.
- Goetz, T. L., T. L. Gu, et al. (2000). "Auto-inhibition of Ets-1 is counteracted by DNA binding cooperativity with core-binding factor alpha2." Mol Cell Biol **20**(1): 81-90.
- Golub, T. R., G. F. Barker, et al. (1995). "Fusion of the TEL gene on 12p13 to the AML1 gene on 21q22 in acute lymphoblastic leukemia." Proc Natl Acad Sci U S A **92**(11): 4917-21.

- Gossen, M. and H. Bujard (1992). "Tight control of gene expression in mammalian cells by tetracycline-responsive promoters." Proc Natl Acad Sci U S A **89**(12): 5547-51.
- Gossen, M., S. Freundlieb, et al. (1995). "Transcriptional activation by tetracyclines in mammalian cells." Science **268**(5218): 1766-9.
- Grogan, J. L. and R. M. Locksley (2002). "T helper cell differentiation: on again, off again." Curr Opin Immunol **14**(3): 366-72.
- Gu, H., J. D. Marth, et al. (1994). "Deletion of a DNA polymerase beta gene segment in T cells using cell type-specific gene targeting." Science **265**(5168): 103-6.
- Gu, T. L., T. L. Goetz, et al. (2000). "Auto-inhibition and partner proteins, core-binding factor beta (CBFbeta) and Ets-1, modulate DNA binding by CBFalpha2 (AML1)." Mol Cell Biol **20**(1): 91-103.
- Hanai, J., L. F. Chen, et al. (1999). "Interaction and functional cooperation of PEBP2/CBF with Smads. Synergistic induction of the immunoglobulin germline Calpha promoter." J Biol Chem **274**(44): 31577-82.
- Harada, H., Y. Harada, et al. (1999). "HERF1, a novel hematopoiesis-specific RING finger protein, is required for terminal differentiation of erythroid cells." Mol Cell Biol **19**(5): 3808-15.
- Harrington, K. S., A. Javed, et al. (2002). "Transcription factors RUNX1/AML1 and RUNX2/Cbfa1 dynamically associate with stationary subnuclear domains." J Cell Sci **115**(Pt 21): 4167-76.
- Harrison, D. E., C. M. Astle, et al. (1979). "Processing by the thymus is not required for cells that cure and populate W/WV recipients." Blood **54**(5): 1152-7.
- Hernandez-Munain, C. and M. S. Krangel (1994). "Regulation of the T-cell receptor delta enhancer by functional cooperation between c-Myb and core-binding factors." Mol Cell Biol **14**(1): 473-83.
- Hess, J., P. J. Nielsen, et al. (2001). "The B lymphocyte-specific coactivator BOB.1/OBF.1 is required at multiple stages of B-cell development." Mol Cell Biol **21**(5): 1531-9.
- Hiebert, S. W., E. F. Reed-Inderbitzin, et al. (2003). "The t(8;21) fusion protein contacts co-repressors and histone deacetylases to repress the transcription of the p14ARF tumor suppressor." Blood Cells Mol Dis **30**(2): 177-83.
- Hillen, W. and C. Berens (1994). "Mechanisms underlying expression of Tn10 encoded tetracycline resistance." Annu Rev Microbiol **48**: 345-69.
- Ho, C. L., S. S. Chin, et al. (1995). "Translation initiation and assembly of peripherin in cultured cells." Eur J Cell Biol **68**(2): 103-12.

- Hoffman, E. S., L. Passoni, et al. (1996). "Productive T-cell receptor beta-chain gene rearrangement: coincident regulation of cell cycle and clonality during development in vivo." Genes Dev **10**(8): 948-62.
- Hsiang, Y. H., D. Spencer, et al. (1993). "The role of viral enhancer "core" motif-related sequences in regulating T cell receptor-gamma and -delta gene expression." J Immunol **150**(9): 3905-16.
- Huang, G., K. Shigesada, et al. (2001). "Dimerization with PEBP2beta protects RUNX1/AML1 from ubiquitin-proteasome-mediated degradation." Embo J **20**(4): 723-33.
- Ichikawa, M., T. Asai, et al. (2004). "AML-1 is required for megakaryocytic maturation and lymphocytic differentiation, but not for maintenance of hematopoietic stem cells in adult hematopoiesis." Nat Med **10**(3): 299-304.
- Imai, Y., M. Kurokawa, et al. (1998). "TLE, the human homolog of groucho, interacts with AML1 and acts as a repressor of AML1-induced transactivation." Biochem Biophys Res Commun **252**(3): 582-9.
- Imai, Y., M. Kurokawa, et al. (2004). "The corepressor mSin3A regulates phosphorylation-induced activation, intranuclear location, and stability of AML1." Mol Cell Biol **24**(3): 1033-43.
- Iwatsuki, K., K. Tanaka, et al. (2004). "Runx1 promotes angiogenesis by downregulation of insulin-like growth factor-binding protein-3." Oncogene.
- Jaffredo, T., R. Gautier, et al. (2000). "Tracing the progeny of the aortic hemangioblast in the avian embryo." Dev Biol **224**(2): 204-14.
- Jaffredo, T., R. Gautier, et al. (1998). "Intraaortic hemopoietic cells are derived from endothelial cells during ontogeny." Development **125**(22): 4575-83.
- Javed, A., B. Guo, et al. (2000). "Groucho/TLE/R-esp proteins associate with the nuclear matrix and repress RUNX (CBF(alpha)/AML/PEBP2(alpha)) dependent activation of tissue-specific gene transcription." J Cell Sci **113** ( Pt 12): 2221-31.
- Johnson, G. R. and M. A. Moore (1975). "Role of stem cell migration in initiation of mouse foetal liver haemopoiesis." Nature **258**(5537): 726-8.
- Jonsen, M. D., J. M. Petersen, et al. (1996). "Characterization of the cooperative function of inhibitory sequences in Ets-1." Mol Cell Biol **16**(5): 2065-73.
- Kamachi, Y., E. Ogawa, et al. (1990). "Purification of a mouse nuclear factor that binds to both the A and B cores of the polyomavirus enhancer." J Virol **64**(10): 4808-19.
- Kanno, T., Y. Kanno, et al. (1998). "Intrinsic transcriptional activation-inhibition domains of the polyomavirus enhancer binding protein 2/core binding factor alpha subunit revealed in the presence of the beta subunit." Mol Cell Biol **18**(5): 2444-54.

- Kellendonk, C., F. Tronche, et al. (1999). "Inducible site-specific recombination in the brain." J Mol Biol **285**(1): 175-82.
- Keller, G., M. Kennedy, et al. (1993). "Hematopoietic commitment during embryonic stem cell differentiation in culture." Mol Cell Biol **13**(1): 473-86.
- Keller, G. M. (1995). "In vitro differentiation of embryonic stem cells." Curr Opin Cell Biol **7**(6): 862-9.
- Kennedy, M., M. Firpo, et al. (1997). "A common precursor for primitive erythropoiesis and definitive haematopoiesis." Nature **386**(6624): 488-93.
- Kessel, J. and B. Fabian (1987). "Inhibitory and stimulatory influences on mesodermal erythropoiesis in the early chick blastoderm." Development **101**(1): 45-9.
- Kim, W. Y., M. Sieweke, et al. (1999). "Mutual activation of Ets-1 and AML1 DNA binding by direct interaction of their autoinhibitory domains." Embo J **18**(6): 1609-20.
- Kistner, A., M. Gossen, et al. (1996). "Doxycycline-mediated quantitative and tissue-specific control of gene expression in transgenic mice." Proc Natl Acad Sci U S A **93**(20): 10933-8.
- Kitabayashi, I., Y. Aikawa, et al. (2001). "Activation of AML1-mediated transcription by MOZ and inhibition by the MOZ-CBP fusion protein." Embo J **20**(24): 7184-96.
- Kitabayashi, I., Y. Aikawa, et al. (2001). "Fusion of MOZ and p300 histone acetyltransferases in acute monocytic leukemia with a t(8;22)(p11;q13) chromosome translocation." Leukemia **15**(1): 89-94.
- Kitabayashi, I., A. Yokoyama, et al. (1998). "Interaction and functional cooperation of the leukemia-associated factors AML1 and p300 in myeloid cell differentiation." Embo J **17**(11): 2994-3004.
- Knoepfler, P. S. and R. N. Eisenman (1999). "Sin meets NuRD and other tails of repression." Cell **99**(5): 447-50.
- Komine, O., K. Hayashi, et al. (2003). "The Runx1 transcription factor inhibits the differentiation of naive CD4+ T cells into the Th2 lineage by repressing GATA3 expression." J Exp Med **198**(1): 51-61.
- Kondo, M., A. J. Wagers, et al. (2003). "Biology of hematopoietic stem cells and progenitors: implications for clinical application." Annu Rev Immunol **21**: 759-806.
- Kozak, M. (1987). "An analysis of 5'-noncoding sequences from 699 vertebrate messenger RNAs." Nucleic Acids Res **15**(20): 8125-48.
- Kozak, M. (1989). "Context effects and inefficient initiation at non-AUG codons in eucaryotic cell-free translation systems." Mol Cell Biol **9**(11): 5073-80.

- Kozak, M. (1991). "An analysis of vertebrate mRNA sequences: intimations of translational control." J Cell Biol **115**(4): 887-903.
- Kozlova, T. and C. S. Thummel (2000). "Steroid regulation of postembryonic development and reproduction in *Drosophila*." Trends Endocrinol Metab **11**(7): 276-80.
- Kozu, T., H. Miyoshi, et al. (1993). "Junctions of the AML1/MTG8(ETO) fusion are constant in t(8;21) acute myeloid leukemia detected by reverse transcription polymerase chain reaction." Blood **82**(4): 1270-6.
- Krestel, H. E., M. Mayford, et al. (2001). "A GFP-equipped bidirectional expression module well suited for monitoring tetracycline-regulated gene expression in mouse." Nucleic Acids Res **29**(7): E39.
- Kuhn, R., F. Schwenk, et al. (1995). "Inducible gene targeting in mice." Science **269**(5229): 1427-9.
- Kumaravelu, P., L. Hook, et al. (2002). "Quantitative developmental anatomy of definitive haematopoietic stem cells/long-term repopulating units (HSC/RUs): role of the aorta-gonad-mesonephros (AGM) region and the yolk sac in colonisation of the mouse embryonic liver." Development **129**(21): 4891-9.
- Kwok, R. P., J. R. Lundblad, et al. (1994). "Nuclear protein CBP is a coactivator for the transcription factor CREB." Nature **370**(6486): 223-6.
- Kyba, M., R. C. Perlingeiro, et al. (2002). "HoxB4 confers definitive lymphoid-myeloid engraftment potential on embryonic stem cell and yolk sac hematopoietic progenitors." Cell **109**(1): 29-37.
- Kyba, M., R. C. Perlingeiro, et al. (2003). "Development of hematopoietic repopulating cells from embryonic stem cells." Methods Enzymol **365**: 114-29.
- Kyba, M., R. C. Perlingeiro, et al. (2003). "Enhanced hematopoietic differentiation of embryonic stem cells conditionally expressing Stat5." Proc Natl Acad Sci U S A **100** Suppl 1: 11904-10.
- Lacaud, G., L. Gore, et al. (2002). "Runx1 is essential for hematopoietic commitment at the hemangioblast stage of development in vitro." Blood **100**(2): 458-66.
- Lakso, M., B. Sauer, et al. (1992). "Targeted oncogene activation by site-specific recombination in transgenic mice." Proc Natl Acad Sci U S A **89**(14): 6232-6.
- Lauzurica, P., X. P. Zhong, et al. (1997). "Regulation of T cell receptor delta gene rearrangement by CBF/PEBP2." J Exp Med **185**(7): 1193-201.
- Legname, G., B. Seddon, et al. (2000). "Inducible expression of a p56Lck transgene reveals a central role for Lck in the differentiation of CD4 SP thymocytes." Immunity **12**(5): 537-46.

- Leonhardt, S. A., V. Boonyaratanakornkit, et al. (2003). "Progesterone receptor transcription and non-transcription signaling mechanisms." Steroids **68**(10-13): 761-70.
- Levanon, D., Y. Bernstein, et al. (1996). "A large variety of alternatively spliced and differentially expressed mRNAs are encoded by the human acute myeloid leukemia gene AML1." DNA Cell Biol **15**(3): 175-85.
- Levanon, D., G. Glusman, et al. (2001). "Architecture and anatomy of the genomic locus encoding the human leukemia-associated transcription factor RUNX1/AML1." Gene **262**(1-2): 23-33.
- Levanon, D., R. E. Goldstein, et al. (1998). "Transcriptional repression by AML1 and LEF-1 is mediated by the TLE/Groucho corepressors." Proc Natl Acad Sci U S A **95**(20): 11590-5.
- Levanon, D., V. Negreanu, et al. (1994). "AML1, AML2, and AML3, the human members of the runt domain gene-family: cDNA structure, expression, and chromosomal localization." Genomics **23**(2): 425-32.
- Levitt, N., D. Briggs, et al. (1989). "Definition of an efficient synthetic poly(A) site." Genes Dev **3**(7): 1019-25.
- Li, F. Q., R. E. Person, et al. (2004). "Lymphoid enhancer factor-1 links two hereditary leukemia syndromes through core-binding factor alpha regulation of ELA2." J Biol Chem **279**(4): 2873-84.
- Liang, J., L. Prouty, et al. (1998). "Acute mixed lineage leukemia with an inv(8)(p11q13) resulting in fusion of the genes for MOZ and TIF2." Blood **92**(6): 2118-22.
- Libermann, T. A., Z. Pan, et al. (1999). "AML1 (CBFalpha2) cooperates with B cell-specific activating protein (BSAP/PAX5) in activation of the B cell-specific BLK gene promoter." J Biol Chem **274**(35): 24671-6.
- Linggi, B., C. Muller-Tidow, et al. (2002). "The t(8;21) fusion protein, AML1 ETO, specifically represses the transcription of the p14(ARF) tumor suppressor in acute myeloid leukemia." Nat Med **8**(7): 743-50.
- Liu, P., S. A. Tarle, et al. (1993). "Fusion between transcription factor CBF beta/PEBP2 beta and a myosin heavy chain in acute myeloid leukemia." Science **261**(5124): 1041-4.
- Lorsbach, R. B., J. Moore, et al. (2004). "Role of RUNX1 in adult hematopoiesis: analysis of RUNX1-IRES-GFP knock-in mice reveals differential lineage expression." Blood **103**(7): 2522-9.

- Lu, J., M. Maruyama, et al. (1995). "Subcellular localization of the alpha and beta subunits of the acute myeloid leukemia-linked transcription factor PEBP2/CBF." Mol Cell Biol **15**(3): 1651-61.
- Lutterbach, B., J. J. Westendorf, et al. (2000). "A mechanism of repression by acute myeloid leukemia-1, the target of multiple chromosomal translocations in acute leukemia." J Biol Chem **275**(1): 651-6.
- Maier, H., R. Ostraat, et al. (2004). "Early B cell factor cooperates with Runx1 and mediates epigenetic changes associated with mb-1 transcription." Nat Immunol **5**(10): 1069-77.
- Mangelsdorf, D. J. and R. M. Evans (1995). "The RXR heterodimers and orphan receptors." Cell **83**(6): 841-50.
- Mansuy, I. M., D. G. Winder, et al. (1998). "Inducible and reversible gene expression with the rtTA system for the study of memory." Neuron **21**(2): 257-65.
- Martin, G. R. (1981). "Isolation of a pluripotent cell line from early mouse embryos cultured in medium conditioned by teratocarcinoma stem cells." Proc Natl Acad Sci U S A **78**(12): 7634-8.
- Matthews, W., C. T. Jordan, et al. (1991). "A receptor tyrosine kinase cDNA isolated from a population of enriched primitive hematopoietic cells and exhibiting close genetic linkage to c-kit." Proc Natl Acad Sci U S A **88**(20): 9026-30.
- Mayall, T. P., P. L. Sheridan, et al. (1997). "Distinct roles for P-CREB and LEF-1 in TCR alpha enhancer assembly and activation on chromatin templates in vitro." Genes Dev **11**(7): 887-99.
- McLeod, M., S. Craft, et al. (1986). "Identification of the crossover site during FLP-mediated recombination in the *Saccharomyces cerevisiae* plasmid 2 microns circle." Mol Cell Biol **6**(10): 3357-67.
- McNeil, S., C. Zeng, et al. (1999). "The t(8;21) chromosomal translocation in acute myelogenous leukemia modifies intranuclear targeting of the AML1/CBFalpha2 transcription factor." Proc Natl Acad Sci U S A **96**(26): 14882-7.
- Medvinsky, A. and E. Dzierzak (1996). "Definitive hematopoiesis is autonomously initiated by the AGM region." Cell **86**(6): 897-906.
- Melnikova, I. N., B. E. Crute, et al. (1993). "Sequence specificity of the core-binding factor." J Virol **67**(4): 2408-11.
- Meyers, S., N. Lenny, et al. (1995). "The t(8;21) fusion protein interferes with AML-1B-dependent transcriptional activation." Mol Cell Biol **15**(4): 1974-82.
- Michaud, J., F. Wu, et al. (2002). "In vitro analyses of known and novel RUNX1/AML1 mutations in dominant familial platelet disorder with predisposition

- to acute myelogenous leukemia: implications for mechanisms of pathogenesis." Blood **99**(4): 1364-72.
- Migliaccio, G., A. R. Migliaccio, et al. (1989). "Selection of lineage-restricted cell lines immortalized at different stages of hematopoietic differentiation from the murine cell line 32D." J Cell Biol **109**(2): 833-41.
- Mitani, K., S. Ogawa, et al. (1994). "Generation of the AML1-EVI-1 fusion gene in the t(3;21)(q26;q22) causes blastic crisis in chronic myelocytic leukemia." Embo J **13**(3): 504-10.
- Mitani, Y., S. H. Zaidi, et al. (2000). "Nitric oxide reduces vascular smooth muscle cell elastase activity through cGMP-mediated suppression of ERK phosphorylation and AML1B nuclear partitioning." Faseb J **14**(5): 805-14.
- Miyoshi, H., M. Ohira, et al. (1995). "Alternative splicing and genomic structure of the AML1 gene involved in acute myeloid leukemia." Nucleic Acids Res **23**(14): 2762-9.
- Miyoshi, H., K. Shimizu, et al. (1991). "t(8;21) breakpoints on chromosome 21 in acute myeloid leukemia are clustered within a limited region of a single gene, AML1." Proc Natl Acad Sci U S A **88**(23): 10431-4.
- Moore, M. A. and D. Metcalf (1970). "Ontogeny of the haemopoietic system: yolk sac origin of in vivo and in vitro colony forming cells in the developing mouse embryo." Br J Haematol **18**(3): 279-96.
- Morrison, S. J., N. Uchida, et al. (1995). "The biology of hematopoietic stem cells." Annu Rev Cell Dev Biol **11**: 35-71.
- Moustakas, A., S. Souchelnytskyi, et al. (2001). "Smad regulation in TGF-beta signal transduction." J Cell Sci **114**(Pt 24): 4359-69.
- Mukouyama, Y., N. Chiba, et al. (2000). "The AML1 transcription factor functions to develop and maintain hematogenic precursor cells in the embryonic aorta-gonad-mesonephros region." Dev Biol **220**(1): 27-36.
- Muller, A. M., A. Medvinsky, et al. (1994). "Development of hematopoietic stem cell activity in the mouse embryo." Immunity **1**(4): 291-301.
- Murphy, K. M. and S. L. Reiner (2002). "The lineage decisions of helper T cells." Nat Rev Immunol **2**(12): 933-44.
- Murray, P. (1932). "The Development of hematopoietic stem cell activity in the mouse embryo." Proc Roy Soc London **11**: 497-521.
- Nagata, T., V. Gupta, et al. (1999). "Immunoglobulin motif DNA recognition and heterodimerization of the PEBP2/CBF Runt domain." Nat Struct Biol **6**(7): 615-9.
- Nakano, T., H. Kodama, et al. (1994). "Generation of lymphohematopoietic cells from embryonic stem cells in culture." Science **265**(5175): 1098-101.

- Namba, K., M. Abe, et al. (2000). "Indispensable role of the transcription factor PEBP2/CBF in angiogenic activity of a murine endothelial cell MSS31." Oncogene **19**(1): 106-14.
- Naylor, L. H. (1999). "Reporter gene technology: the future looks bright." Biochem Pharmacol **58**(5): 749-57.
- Nguyen, L. A., P. P. Pandolfi, et al. (2005). "Physical and functional link of the leukemia-associated factors AML1 and PML." Blood **105**(1): 292-300.
- Nichols, J., B. Zevnik, et al. (1998). "Formation of pluripotent stem cells in the mammalian embryo depends on the POU transcription factor Oct4." Cell **95**(3): 379-91.
- Niizeki, O., H. Miyashita, et al. (2004). "Transcriptional regulation of angiogenesis-related puromycin-insensitive leucyl-specific aminopeptidase in endothelial cells." Arch Biochem Biophys **424**(1): 63-71.
- Niki, M., H. Okada, et al. (1997). "Hematopoiesis in the fetal liver is impaired by targeted mutagenesis of a gene encoding a non-DNA binding subunit of the transcription factor, polyomavirus enhancer binding protein 2/core binding factor." Proc Natl Acad Sci U S A **94**(11): 5697-702.
- Nishikawa, S. I., S. Nishikawa, et al. (1998). "Progressive lineage analysis by cell sorting and culture identifies FLK1+VE-cadherin+ cells at a diverging point of endothelial and hemopoietic lineages." Development **125**(9): 1747-57.
- Nishikawa, S. I., S. Nishikawa, et al. (1998). "In vitro generation of lymphohematopoietic cells from endothelial cells purified from murine embryos." Immunity **8**(6): 761-9.
- Nishimura, M., Y. Fukushima-Nakase, et al. (2004). "VWRPY motif-dependent and -independent roles of AML1/Runx1 transcription factor in murine hematopoietic development." Blood **103**(2): 562-70.
- Niwa, H., T. Burdon, et al. (1998). "Self-renewal of pluripotent embryonic stem cells is mediated via activation of STAT3." Genes Dev **12**(13): 2048-60.
- Niwa, H., J. Miyazaki, et al. (2000). "Quantitative expression of Oct-3/4 defines differentiation, dedifferentiation or self-renewal of ES cells." Nat Genet **24**(4): 372-6.
- Niwa, H., K. Yamamura, et al. (1991). "Efficient selection for high-expression transfectants with a novel eukaryotic vector." Gene **108**(2): 193-9.
- No, D., T. P. Yao, et al. (1996). "Ecdysone-inducible gene expression in mammalian cells and transgenic mice." Proc Natl Acad Sci U S A **93**(8): 3346-51.
- North, T., T. L. Gu, et al. (1999). "Cbfa2 is required for the formation of intra-aortic hematopoietic clusters." Development **126**(11): 2563-75.

- North, T. E., M. F. de Bruijn, et al. (2002). "Runx1 expression marks long-term repopulating hematopoietic stem cells in the midgestation mouse embryo." Immunity **16**(5): 661-72.
- North, T. E., T. Stacy, et al. (2004). "Runx1 is expressed in adult mouse hematopoietic stem cells and differentiating myeloid and lymphoid cells, but not in maturing erythroid cells." Stem Cells **22**(2): 158-68.
- Nuchprayoon, I., S. Meyers, et al. (1994). "PEBP2/CBF, the murine homolog of the human myeloid AML1 and PEBP2 beta/CBF beta proto-oncoproteins, regulates the murine myeloperoxidase and neutrophil elastase genes in immature myeloid cells." Mol Cell Biol **14**(8): 5558-68.
- Ogawa, E., M. Inuzuka, et al. (1993). "Molecular cloning and characterization of PEBP2 beta, the heterodimeric partner of a novel Drosophila runt-related DNA binding protein PEBP2 alpha." Virology **194**(1): 314-31.
- Ogawa, E., M. Maruyama, et al. (1993). "PEBP2/PEA2 represents a family of transcription factors homologous to the products of the Drosophila runt gene and the human AML1 gene." Proc Natl Acad Sci U S A **90**(14): 6859-63.
- Ogryzko, V. V., R. L. Schiltz, et al. (1996). "The transcriptional coactivators p300 and CBP are histone acetyltransferases." Cell **87**(5): 953-9.
- Oikawa, T. and T. Yamada (2003). "Molecular biology of the Ets family of transcription factors." Gene **303**: 11-34.
- Okada, H., T. Watanabe, et al. (1998). "AML1(-/-) embryos do not express certain hematopoiesis-related gene transcripts including those of the PU.1 gene." Oncogene **17**(18): 2287-93.
- Okuda, T., K. Takeda, et al. (2000). "Biological characteristics of the leukemia-associated transcriptional factor AML1 disclosed by hematopoietic rescue of AML1-deficient embryonic stem cells by using a knock-in strategy." Mol Cell Biol **20**(1): 319-28.
- Okuda, T., J. van Deursen, et al. (1996). "AML1, the target of multiple chromosomal translocations in human leukemia, is essential for normal fetal liver hematopoiesis." Cell **84**(2): 321-30.
- Olsson, I. L. and T. R. Breitman (1982). "Induction of differentiation of the human histiocytic lymphoma cell line U-937 by retinoic acid and cyclic adenosine 3':5'-monophosphate-inducing agents." Cancer Res **42**(10): 3924-7.
- Palmiter, R. D. and R. L. Brinster (1986). "Germ-line transformation of mice." Annu Rev Genet **20**: 465-99.

- Pardali, E., X. Q. Xie, et al. (2000). "Smad and AML proteins synergistically confer transforming growth factor beta1 responsiveness to human germ-line IgA genes." J Biol Chem **275**(5): 3552-60.
- Patan, S. (2000). "Vasculogenesis and angiogenesis as mechanisms of vascular network formation, growth and remodeling." J Neurooncol **50**(1-2): 1-15.
- Pearse, M., L. Wu, et al. (1989). "A murine early thymocyte developmental sequence is marked by transient expression of the interleukin 2 receptor." Proc Natl Acad Sci U S A **86**(5): 1614-8.
- Perry, C., A. Eldor, et al. (2002). "Runx1/AML1 in leukemia: disrupted association with diverse protein partners." Leuk Res **26**(3): 221-8.
- Petrovick, M. S., S. W. Hiebert, et al. (1998). "Multiple functional domains of AML1: PU.1 and C/EBPalpha synergize with different regions of AML1." Mol Cell Biol **18**(7): 3915-25.
- Phillips, R. L., R. E. Ernst, et al. (2000). "The genetic program of hematopoietic stem cells." Science **288**(5471): 1635-40.
- Pozner, A., D. Goldenberg, et al. (2000). "Transcription-coupled translation control of AML1/RUNX1 is mediated by cap- and internal ribosome entry site-dependent mechanisms." Mol Cell Biol **20**(7): 2297-307.
- Quinn, T. P., K. G. Peters, et al. (1993). "Fetal liver kinase 1 is a receptor for vascular endothelial growth factor and is selectively expressed in vascular endothelium." Proc Natl Acad Sci U S A **90**(16): 7533-7.
- Rabinovitch, M. (1999). "EVE and beyond, retro and prospective insights." Am J Physiol **277**(1 Pt 1): L5-12.
- Redondo, J. M., J. L. Pfohl, et al. (1991). "Identification of an essential site for transcriptional activation within the human T-cell receptor delta enhancer." Mol Cell Biol **11**(11): 5671-80.
- Rothenberg, E. V. (2002). "T-lineage specification and commitment: a gene regulation perspective." Semin Immunol **14**(6): 431-40.
- Rudolph, M. J. and J. P. Gergen (2001). "DNA-binding by Ig-fold proteins." Nat Struct Biol **8**(5): 384-6.
- Sabin, F. (1920). "Studies on the origin of blood vessels and of red corpuscles as seen in the living blastoderm of the chick during the second day of incubation." Contribution to Embryology **9**: 213-262.
- Saez, E., M. C. Nelson, et al. (2000). "Identification of ligands and coligands for the ecdysone-regulated gene switch." Proc Natl Acad Sci U S A **97**(26): 14512-7.
- Sambrook, J., E. F. Fritsch, et al. (1989). Molecular Cloning: a Laboratory Manual, Cold Spring Harbor Laboratory Press.

- Sasaki, K., H. Yagi, et al. (1996). "Absence of fetal liver hematopoiesis in mice deficient in transcriptional coactivator core binding factor beta." Proc Natl Acad Sci U S A **93**(22): 12359-63.
- Satake, M., S. Nomura, et al. (1995). "Expression of the Runt domain-encoding PEBP2 alpha genes in T cells during thymic development." Mol Cell Biol **15**(3): 1662-70.
- Sato, Y. (2003). "Aminopeptidases and angiogenesis." Endothelium **10**(6): 287-90.
- Sauer, B. (2002). "Cre/lox: one more step in the taming of the genome." Endocrine **19**(3): 221-8.
- Sauer, B. and N. Henderson (1988). "Site-specific DNA recombination in mammalian cells by the Cre recombinase of bacteriophage P1." Proc Natl Acad Sci U S A **85**(14): 5166-70.
- Sauer, B. and N. Henderson (1990). "Targeted insertion of exogenous DNA into the eukaryotic genome by the Cre recombinase." New Biol **2**(5): 441-9.
- Schmid, I., W. J. Krall, et al. (1992). "Dead cell discrimination with 7-aminomycin D in combination with dual color immunofluorescence in single laser flow cytometry." Cytometry **13**(2): 204-8.
- Schneider, A., Y. Zhang, et al. (2003). "Differential, inducible gene targeting in renal epithelia, vascular endothelium, and viscera of Mx1Cre mice." Am J Physiol Renal Physiol **284**(2): F411-7.
- Senecoff, J. F., R. C. Bruckner, et al. (1985). "The FLP recombinase of the yeast 2-micron plasmid: characterization of its recombination site." Proc Natl Acad Sci U S A **82**(21): 7270-4.
- Shalaby, F., J. Rossant, et al. (1995). "Failure of blood-island formation and vasculogenesis in Flk-1-deficient mice." Nature **376**(6535): 62-6.
- Sherf, B. A., S. L. Navarro, et al. (1996). "Dual-Luciferase™ Reporter Assay: An Advanced Co-Reporter Technology Integrating Firefly and Renilla Luciferase Assays." Promega Notes **57**: 2.
- Shi, M. J. and J. Stavnezer (1998). "CBF alpha3 (AML2) is induced by TGF-beta1 to bind and activate the mouse germline Ig alpha promoter." J Immunol **161**(12): 6751-60.
- Shin, M. K., J. M. LeVorse, et al. (1999). "The temporal requirement for endothelin receptor-B signalling during neural crest development." Nature **402**(6761): 496-501.
- Simeone, A., A. Daga, et al. (1995). "Expression of runt in the mouse embryo." Dev Dyn **203**(1): 61-70.
- Smith, A. (1991). "Culture and differentiation of embryonic stem cells." J Tiss Cult Meth **13**: 89-94.

- Smith, A. G. (2001). "Embryo-derived stem cells: of mice and men." Annu Rev Cell Dev Biol **17**: 435-62.
- Smith, A. G., J. K. Heath, et al. (1988). "Inhibition of pluripotential embryonic stem cell differentiation by purified polypeptides." Nature **336**(6200): 688-90.
- Song, W. J., M. G. Sullivan, et al. (1999). "Haploinsufficiency of CBFA2 causes familial thrombocytopenia with propensity to develop acute myelogenous leukaemia." Nat Genet **23**(2): 166-75.
- Sonoda, T., Y. Kitamura, et al. (1983). "Mast-cell precursors in various haematopoietic colonies of mice produced in vivo and in vitro." Br J Haematol **53**(4): 611-20.
- Speck, N. A. (2001). "Core binding factor and its role in normal hematopoietic development." Curr Opin Hematol **8**(4): 192-6.
- Springer, T. A. (1990). "Adhesion receptors of the immune system." Nature **346**(6283): 425-34.
- Stavnezer, J. (2000). "Molecular processes that regulate class switching." Curr Top Microbiol Immunol **245**(2): 127-68.
- Stein, G. S., A. J. van Wijnen, et al. (1998). "Interrelationships of nuclear structure and transcriptional control: functional consequences of being in the right place at the right time." J Cell Biochem **70**(2): 200-12.
- Stephenson, J. R., A. A. Axelrad, et al. (1971). "Induction of colonies of hemoglobin-synthesizing cells by erythropoietin in vitro." Proc Natl Acad Sci U S A **68**(7): 1542-6.
- Sternberg, N. and D. Hamilton (1981). "Bacteriophage P1 site-specific recombination. I. Recombination between loxP sites." J Mol Biol **150**(4): 467-86.
- Sun, W., B. J. Graves, et al. (1995). "Transactivation of the Moloney murine leukemia virus and T-cell receptor beta-chain enhancers by cbf and ets requires intact binding sites for both proteins." J Virol **69**(8): 4941-9.
- Takakura, N., T. Watanabe, et al. (2000). "A role for hematopoietic stem cells in promoting angiogenesis." Cell **102**(2): 199-209.
- Tanaka, K., T. Tanaka, et al. (1995). "Increased expression of AML1 during retinoic-acid-induced differentiation of U937 cells." Biochem Biophys Res Commun **211**(3): 1023-30.
- Tanaka, T., K. Tanaka, et al. (1995). "An acute myeloid leukemia gene, AML1, regulates hemopoietic myeloid cell differentiation and transcriptional activation antagonistically by two alternative spliced forms." Embo J **14**(2): 341-50.

- Taniuchi, I., M. Osato, et al. (2002). "Differential requirements for Runx proteins in CD4 repression and epigenetic silencing during T lymphocyte development." Cell **111**(5): 621-33.
- Telfer, J. C. and E. V. Rothenberg (2001). "Expression and function of a stem cell promoter for the murine CBFalpha2 gene: distinct roles and regulation in natural killer and T cell development." Dev Biol **229**(2): 363-82.
- Tracey, W. D. and N. A. Speck (2000). "Potential roles for RUNX1 and its orthologs in determining hematopoietic cell fate." Semin Cell Dev Biol **11**(5): 337-42.
- Triezenberg, S. J., R. C. Kingsbury, et al. (1988). "Functional dissection of VP16, the trans-activator of herpes simplex virus immediate early gene expression." Genes Dev **2**(6): 718-29.
- Tsuji, K. and M. Noda (2000). "Identification and expression of a novel 3'-exon of mouse Runx1/Pebp2alphaB/Cbfa2/AML1 gene." Biochem Biophys Res Commun **274**(1): 171-6.
- Tucker, P., L. Laemle, et al. (2001). "The eyeless mouse mutation (ey1) removes an alternative start codon from the Rx/rax homeobox gene." Genesis **31**(1): 43-53.
- Urlinger, S., U. Baron, et al. (2000). "Exploring the sequence space for tetracycline-dependent transcriptional activators: novel mutations yield expanded range and sensitivity." Proc Natl Acad Sci U S A **97**(14): 7963-8.
- Van Craenenbroeck, K., P. Vanhoenacker, et al. (2000). "Episomal vectors for gene expression in mammalian cells." Eur J Biochem **267**(18): 5665-78.
- van der Velden, A. W. and A. A. Thomas (1999). "The role of the 5' untranslated region of an mRNA in translation regulation during development." Int J Biochem Cell Biol **31**(1): 87-106.
- Vegeto, E., G. F. Allan, et al. (1992). "The mechanism of RU486 antagonism is dependent on the conformation of the carboxy-terminal tail of the human progesterone receptor." Cell **69**(4): 703-13.
- Vermes, I., C. Haanen, et al. (2000). "Flow cytometry of apoptotic cell death." J Immunol Methods **243**(1-2): 167-90.
- Wang, Q., T. Stacy, et al. (1996). "Disruption of the Cbfa2 gene causes necrosis and hemorrhaging in the central nervous system and blocks definitive hematopoiesis." Proc Natl Acad Sci U S A **93**(8): 3444-9.
- Wang, Q., T. Stacy, et al. (1996). "The CBFbeta subunit is essential for CBFalpha2 (AML1) function in vivo." Cell **87**(4): 697-708.
- Wang, S., Q. Wang, et al. (1993). "Cloning and characterization of subunits of the T-cell receptor and murine leukemia virus enhancer core-binding factor." Mol Cell Biol **13**(6): 3324-39.

- Wang, S. W. and N. A. Speck (1992). "Purification of core-binding factor, a protein that binds the conserved core site in murine leukemia virus enhancers." Mol Cell Biol **12**(1): 89-102.
- Wang, Y., F. J. DeMayo, et al. (1997). "Ligand-inducible and liver-specific target gene expression in transgenic mice." Nat Biotechnol **15**(3): 239-43.
- Wang, Y., B. W. O'Malley, Jr., et al. (1994). "A regulatory system for use in gene transfer." Proc Natl Acad Sci U S A **91**(17): 8180-4.
- Wang, Y., J. Xu, et al. (1997). "Positive and negative regulation of gene expression in eukaryotic cells with an inducible transcriptional regulator." Gene Ther **4**(5): 432-41.
- Ward, N. L. and D. J. Dumont (2002). "The angiopoietins and Tie2/Tek: adding to the complexity of cardiovascular development." Semin Cell Dev Biol **13**(1): 19-27.
- Westendorf, J. J. and S. W. Hiebert (1999). "Mammalian runt-domain proteins and their roles in hematopoiesis, osteogenesis, and leukemia." J Cell Biochem Suppl **32-33**: 51-8.
- Wigle, D. A., K. E. Thompson, et al. (1998). "AML1-like transcription factor induces serine elastase activity in ovine pulmonary artery smooth muscle cells." Circ Res **83**(3): 252-63.
- Wijmenga, C., N. A. Speck, et al. (1995). "Identification of a new murine runt domain-containing gene, Cbfa3, and localization of the human homolog, CBFA3, to chromosome 1p35-pter." Genomics **26**(3): 611-4.
- Wiles, M. V. and G. Keller (1991). "Multiple hematopoietic lineages develop from embryonic stem (ES) cells in culture." Development **111**(2): 259-67.
- Williams, R. L., D. J. Hilton, et al. (1988). "Myeloid leukaemia inhibitory factor maintains the developmental potential of embryonic stem cells." Nature **336**(6200): 684-7.
- Woolf, E., C. Xiao, et al. (2003). "Runx3 and Runx1 are required for CD8 T cell development during thymopoiesis." Proc Natl Acad Sci U S A **100**(13): 7731-6.
- Wotton, D., J. Ghysdael, et al. (1994). "Cooperative binding of Ets-1 and core binding factor to DNA." Mol Cell Biol **14**(1): 840-50.
- Wutz, A., T. P. Rasmussen, et al. (2002). "Chromosomal silencing and localization are mediated by different domains of Xist RNA." Nat Genet **30**(2): 167-74.
- Xie, X. Q., E. Pardali, et al. (1999). "AML and Ets proteins regulate the I alpha 1 germ-line promoter." Eur J Immunol **29**(2): 488-98.
- Yagi, R., L. F. Chen, et al. (1999). "A WW domain-containing yes-associated protein (YAP) is a novel transcriptional co-activator." Embo J **18**(9): 2551-62.

- Yamaguchi, T. P., D. J. Dumont, et al. (1993). "flk-1, an flt-related receptor tyrosine kinase is an early marker for endothelial cell precursors." Development **118**(2): 489-98.
- Yamaguchi, Y., M. Kurokawa, et al. (2004). "AML1 is functionally regulated through p300-mediated acetylation on specific lysine residues." J Biol Chem **279**(15): 15630-8.
- Yanai, N., T. Satoh, et al. (1991). "Endothelial cells create a hematopoietic inductive microenvironment preferential to erythropoiesis in the mouse spleen." Cell Struct Funct **16**(1): 87-93.
- Yang, X. J., V. V. Ogryzko, et al. (1996). "A p300/CBP-associated factor that competes with the adenoviral oncoprotein E1A." Nature **382**(6589): 319-24.
- Yannoutsos, N., V. Barreto, et al. (2004). "A cis element in the recombination activating gene locus regulates gene expression by counteracting a distant silencer." Nat Immunol **5**(4): 443-50.
- Yao, T. P., W. A. Se graves, et al. (1992). "Drosophila ultraspiracle modulates ecdysone receptor function via heterodimer formation." Cell **71**(1): 63-72.
- Ying, Q. L., J. Nichols, et al. (2003). "BMP induction of Id proteins suppresses differentiation and sustains embryonic stem cell self-renewal in collaboration with STAT3." Cell **115**(3): 281-92.
- Yokomizo, T., M. Ogawa, et al. (2001). "Requirement of Runx1/AML1/PEBP2alphaB for the generation of haematopoietic cells from endothelial cells." Genes Cells **6**(1): 13-23.
- Zaidi, S. K., A. J. Sullivan, et al. (2002). "Integration of Runx and Smad regulatory signals at transcriptionally active subnuclear sites." Proc Natl Acad Sci U S A **99**(12): 8048-53.
- Zaiman, A. L., A. F. Lewis, et al. (1995). "Transcriptional activity of core binding factor-alpha (AML1) and beta subunits on murine leukemia virus enhancer cores." J Virol **69**(5): 2898-906.
- Zambrowicz, B. P., A. Imamoto, et al. (1997). "Disruption of overlapping transcripts in the ROSA beta geo 26 gene trap strain leads to widespread expression of beta-galactosidase in mouse embryos and hematopoietic cells." Proc Natl Acad Sci U S A **94**(8): 3789-94.
- Zamoyska, R., A. Basson, et al. (2003). "The influence of the src-family kinases, Lck and Fyn, on T cell differentiation, survival and activation." Immunol Rev **191**: 107-18.

- Zeng, C., S. McNeil, et al. (1998). "Intranuclear targeting of AML/CBFalpha regulatory factors to nuclear matrix-associated transcriptional domains." Proc Natl Acad Sci U S A **95**(4): 1585-9.
- Zeng, C., A. J. van Wijnen, et al. (1997). "Identification of a nuclear matrix targeting signal in the leukemia and bone-related AML/CBF-alpha transcription factors." Proc Natl Acad Sci U S A **94**(13): 6746-51.
- Zhang, D. E., K. Fujioka, et al. (1994). "Identification of a region which directs the monocytic activity of the colony-stimulating factor 1 (macrophage colony-stimulating factor) receptor promoter and binds PEBP2/CBF (AML1)." Mol Cell Biol **14**(12): 8085-95.
- Zhang, D. E., C. J. Hetherington, et al. (1996). "CCAAT enhancer-binding protein (C/EBP) and AML1 (CBF alpha2) synergistically activate the macrophage colony-stimulating factor receptor promoter." Mol Cell Biol **16**(3): 1231-40.
- Zhang, Y. and R. Derynck (2000). "Transcriptional regulation of the transforming growth factor-beta -inducible mouse germ line Ig alpha constant region gene by functional cooperation of Smad, CREB, and AML family members." J Biol Chem **275**(22): 16979-85.
- Zhang, Y. W., S. C. Bae, et al. (1997). "A novel transcript encoding an N-terminally truncated AML1/PEBP2 alphaB protein interferes with transactivation and blocks granulocytic differentiation of 32Dcl3 myeloid cells." Mol Cell Biol **17**(7): 4133-45.

## APPENDIX

Sequence of the Ainv15 cells genomic DNA fragment encompassing *loxP* site.

TTTGACCTCCATAGAAGACACCGGGACCGATCCAGCCTCCGCGGCCCGA  
ATTCGAGCTCGGTACCCGGGGATCCTCTAGTCAGTCGAGGGACCTAATAA  
CTTCGTATAGCATAACATTATACGAAGTTATATAAGGGTTCCGGGGTACCT  
CTAGAGGTACCTGGATTGCACGCAGGTTCTCCGGCCGCTTGGGTGGAGAG  
GCTATTCGGCTATGACTGGGCACAACAGACAATCGGCT

*loxP* site is underlined.