



Ship transport of CO₂ for Enhanced Oil Recovery – Literature Survey

January 2015

Dr Peter Brownsort, SCCS

Table of Contents

1	Introduction.....	5
1.1	Role for shipping in CO ₂ -EOR	5
1.2	Report structure and bibliography	6
2	Literature Searches	7
2.1	Direct Internet Searches.....	7
2.2	Secondary reference searches.....	8
2.3	Prioritisation and selection of publications for detailed review	8
3	Review of literature on ship transport of CO ₂	9
3.1	Overview of available literature	9
3.2	Purpose of studies	10
3.3	Reviews of key publications	11
4	Technology for CO ₂ shipping	16
4.1	Liquefaction	16
4.2	Intermediate storage at loading point.....	17
4.3	Ship loading	17
4.4	Ship design	18
4.4.1	Existing experience.....	18
4.4.2	Proposed ship designs.....	19
4.5	Ship offloading.....	21
4.5.1	Offloading to shore.....	21
4.5.2	Offshore offloading.....	21
4.6	Injection	25
5	Costs of CO ₂ transport by ship.....	27
5.1	Shipping cost estimates.....	27
5.1.1	Cost breakdown	28
5.2	Comparison of shipping with pipeline costs	28

5.3	Cost sensitivities	30
5.4	Financial risk, asset flexibility	31
6	Regulation and HSE aspects	32
6.1	Regulations on CO ₂ shipping	32
6.2	Carbon footprint, CO ₂ emissions of shipping systems	32
6.3	HSE aspects	33
6.3.1	Risk assessment	33
6.3.2	Dynamic behaviour, operational issues	34
7	Conclusions	36
8	Bibliography and additional references	38
8.1	Bibliography	38
8.2	Additional references	42
	Appendix 1 – Scope Document	43

Ship transport of CO₂ for Enhanced Oil Recovery – Literature Survey

Author: Dr Peter Brownsort; Scottish Carbon Capture & Storage (SCCS), August 2014

1 Introduction

Transport of carbon dioxide (CO₂) by ship may fulfil a key role in the development of carbon capture and storage (CCS), particularly for CO₂-enhanced oil recovery (EOR) in the North Sea where a flexible transport system may be advantageous. Shipping of liquefied CO₂ already occurs, albeit at a limited scale, to service the industrial gases market. Use of shipping to supply early-phase CO₂-EOR projects may bring benefits including the flexibility to use equipment in several projects, ability to collect from existing industrial sources and moderate capital costs compared to new pipelines. A number of studies have focussed on use of shipping for CO₂ transport in the context of CCS; this work package has assessed the available literature, reviewed appropriate studies in detail and summarises in this report the main points of note for CO₂-EOR interests.

The purpose of the work package is detailed in the scoping document, attached as Appendix 1. The key aims are to:

- determine the extent and scope of literature on transport of CO₂ by ship;
- review a selection of available literature to extract and report the key findings of interest for CO₂-EOR, with a focus on options for loading/offloading and comparative costs against other transport modes.

1.1 Role for shipping in CO₂-EOR

The potential role for shipping in developing CO₂-EOR has been recognised since the early 2000's and was first explored in detail by a project involving SINTEF, STATOIL, Teekay Shipping and others. This led to a number of publications including a paper from Aspelund, Mølnevik and de Koeijer (2006) in which they explain the fundamental logic of using a ship-based transport system for EOR as follows:

- EOR can provide a financial incentive, giving a value to CO₂.
- Shipping allows flexible collection of CO₂ from low costs sources (e.g. ammonia plants and refineries).
- Shipping allows flexibility for delivery to different locations for EOR as fields pass maturity at different times.
- Shipping options involve relatively low capital expenditure (CAPEX) compared to pipeline options, so are lower risk.
- CO₂ carriers may have residual value as LPG carriers after use for EOR projects.

Overall, they propose, and subsequent studies have supported, that shipping can be a cost-effective transport option for CO₂ in certain cases, generally where transport distances are longer and where quantities are lower. However, most studies concerning ship transport of CO₂ are not specifically related to EOR, but often mention it alongside 'straightforward' geological storage.

1.2 Report structure and bibliography

This report first outlines, in Section 2, the literature searches used to build a bibliography on CO₂ transport by ship and the process of selection of the most relevant publications for detailed review. Section 3 gives an overview of available literature, outlines the purposes of studies selected and gives brief reviews of some of the more relevant reports and papers. Section 4 describes the technologies necessary for a CO₂ transport chain involving shipping, with reference to EOR where appropriate. Costs estimates of ship-based CO₂ transport are summarised in Section 5, together with a review of cost comparisons between shipping and pipeline costs. Section 6 deals with regulatory aspects and health, safety and environment (HSE) as covered in the literature. Some concluding remarks follow in Section 7 relating the findings of this review to CO₂-EOR as far as possible.

The bibliography is listed in full at the end of the report. Electronic copies of the documents are archived in the SCCS shared area folders under the CO₂-EOR Joint Industry Project (JIP) folder (Project Number SCCS0002) and in the author's EndNote library. Individual copies or a zipped folder of the bibliography are available to project members on request from the author.

2 Literature Searches

A few well-known reports were already to hand:

- two series of reports supported by the Global CCS Institute (GCCSI):
 - the Vopak-Veder series (Vermeulen, 2011; Tetteroo and van de Ben, 2011; ter Moors, 2011; Koers and de Looij, 2011);
 - the Chiyoda Corporation series (Omata, 2011; Omata, 2012a; Omata 2012b);
- the Petrofac Peterhead study (Giles, 2012).

Literature searches were carried out in two phases, using direct Internet searches and by following secondary references from primary results of the direct searches.

2.1 Direct Internet Searches

Google Scholar searches were made using the terms “ship transport CO₂” and “shipping CO₂” with hits manually sifted out to the tenth page of hits.

A Web of Knowledge/Science search was made using terms “ship transport CO₂”, “ship shipping transport CO₂”, “ship shipping transport CO₂ carbon dioxide”. Hits were manually sifted for relevance. Where hits were obtained from Science Direct, the ‘recommended other articles’ feature was used to gain further relevant references.

An advanced search using Science Direct was made with the following parameters:

Term: ship* transport* in Field: Title, Abstract, Keywords
AND
Term: CO₂ in Field: All Fields
Limitation: excludes biological and medical sciences
Limitation: excludes NO_x emissions, Indian Ocean, fuel cells

From these searches fifty-five relevant publications were identified with the following distribution by type:

1 diploma thesis
2 book chapters
3 patents
11 ‘grey literature’¹ reports
16 peer-reviewed papers
22 conference papers

With the exception of one patent (Mitsubishi Jukogyo KK, 2002) electronic copies of all publications were retrieved and saved in the bibliography.

¹ Grey literature – informally published, respectable reports obtained from Internet; not peer-reviewed and may be subjective reflecting views of organisations conducting research.

2.2 Secondary reference searches

Sixteen publications, both peer-reviewed and 'grey literature', were selected and their references checked to identify further relevant literature. The selected publications included previous review papers and key academic papers covering different time frames, research groups and regions. Most references were either cross-references to publications already identified in the primary searches or they were not relevant to the central theme of this survey. Only one new publication, Svensson *et al* (2004a), was added to the bibliography through this process.

The fact that only one new reference was found by this secondary process may suggest that the bibliography compiled is fairly comprehensive for the subject. Indeed, in further, more detailed reading of selected publications only one more reference of note was discovered. However, this was a significant 'grey literature' publication – the Zero Emissions Platform's (ZEP) report on the costs of CO₂ transport (ZEP, 2011) – highlighting that a search such as that conducted here can never be truly comprehensive.

2.3 Prioritisation and selection of publications for detailed review

Based on a developing feel for the scope and content of the literature identified, publications were allocated a 'star rating', from one to five stars. Thirteen publications were given four or five stars and were reviewed in detail. Reading notes taken from these are available in the SCCS shared project folder and could be made available to project members on request. These publications are summarised briefly in the next section.

Publications allocated three or fewer stars have not been reviewed at the same level of detail, although this does not imply they are without significance. These others have still shaped this report to varying extent and are referenced where appropriate.

3 Review of literature on ship transport of CO₂

3.1 Overview of available literature

The earliest reference found is a Japanese patent from Mitsubishi Heavy Industries (Mitsubishi Jukogyo KK, 2002) entitled *Carbon dioxide handling involves using liquefied petroleum gas ship for conveying carbon dioxide*. The full text has not been found in English but abstracts suggest the invention concerns use of liquefied petroleum gas (LPG) ships for carrying CO₂ either for EOR, or geological storage, or deep-ocean storage.

This patent gives the hint to most of the field – CO₂ can be carried by ship using well-established technologies (and sometimes the same equipment) developed for LPG.

Following their patent, Mitsubishi Heavy Industries (2004) produced an early report for the International Energy Authority Greenhouse Gas (IEAGHG) Research and Development (R&D) Programme but thereafter the focus of publication on CO₂ shipping switched to Europe, principally Scandinavia, until the last few years when there has been a more even split between Europe more generally and the Far East. It is notable that no literature on CO₂ shipping stemming primarily from North America has been identified; this is presumably due to the existence of widespread onshore CO₂ transport by pipeline and acceptance of onshore EOR and geological storage. Groups publishing in recent years have been from Europe (Norway, Sweden, Finland, The Netherlands, France) and the Far East (Japan, Korea).

Much of the published work in the mid 2000's was from a project comprising SINTEF Energy Research, STATOIL and others, based at Trondheim, Norway. This led to several presentations at the GHGT-7 conference in Vancouver, November 2004, at least one significant peer-reviewed paper (Aspelund, Mølnevik and de Koeijer, 2006) and two patents.

The most prominent author from this group, Audun Aspelund, later moved to the Norwegian University of Science and Technology, Trondheim, where he continued research and publication in the field, extending it to a combined 'liquefied energy chain' for recovery of natural gas from 'stranded assets' with related storage of CO₂ (Aspelund and Gundersen, 2009a,b,c; Aspelund, Tveit and Gundersen, 2009).

About 60% of the publications identified have been from 2010 and later; these have been spread between the regions and countries mentioned above. They are mostly peer-reviewed or conference papers, with a few reports from institutions, consultancies and companies/partnerships. Figures 1, 2, 3 illustrate the distribution of publications.

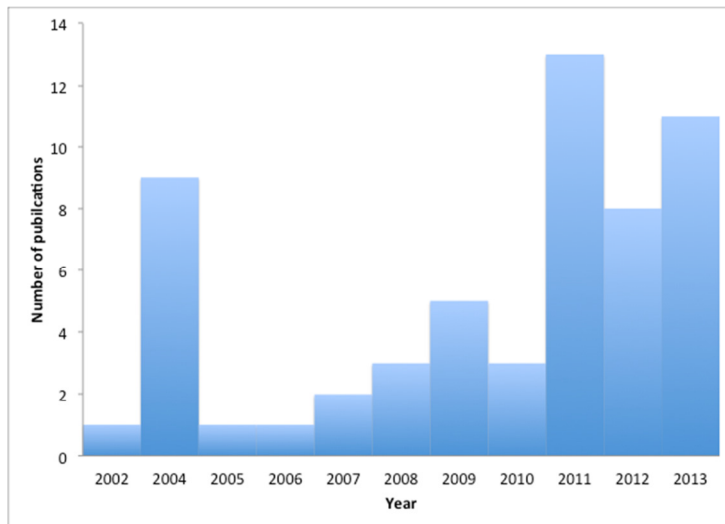

Figure 1. Distribution by year of publications mentioning ship transport of CO₂

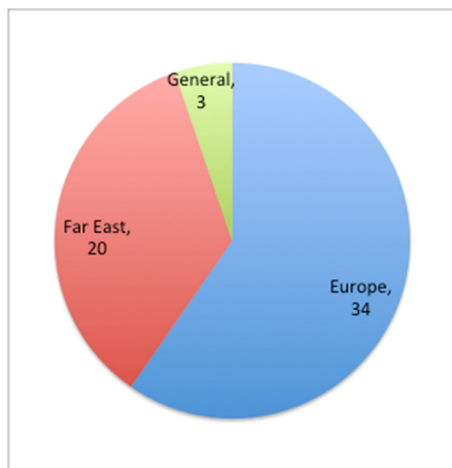

Figure 2. Distribution by region



Figure 3. Distribution by type

3.2 Purpose of studies

The bibliography contains a variety of types of publication as outlined in Section 2, including review chapters, and reports or peer-reviewed papers from primary studies. The purposes of some key publications are summarised in the following Section; purposes overall are described in general below.

The purpose of the primary studies reviewed varies from essentially academic, methodological and modelling work (e.g. Roussanaly, Bureau-Cauchois and Husebye 2013; Nam *et al*, 2013) to studies serving commercial interests, developing concepts that may lead to future markets for products (e.g. Vermeulen, 2011; Yoo *et al*, 2013).

Many studies consider economic aspects of CO₂ shipping with several giving cost comparisons with pipeline transport, either offshore or onshore (see Section 5.2). Few publications are specific to ship transport for EOR (Hegerland, Jørgensen and Pande, 2004; Berger, Kaarstad and Haugen, 2004) although many mention the possibility and the advantage that ships may bring to EOR through flexibility and relatively low capital outlay.

At a technical level, several studies deal with the processes of CO₂ liquefaction for ship transport with energy comparisons for different process options, some give details of ship design, while fewer give detailed considerations of the offloading processes. In particular, there is limited consideration reported of the coupling technology needed for offloading (Aspelund, Mølnevik and de Koeijer, 2006; Vermeulen, 2011; Omata, 2011, 2012a). The issues of matching CO₂ supply with injection rates or profiles that may be required for EOR are not well covered, although the option of downstream intermediate storage (either offshore or at inlet to injection pipeline system) is mentioned in some papers (Hegerland, Jørgensen and Pande, 2004; Nam *et al*, 2013; Yoo *et al*, 2013).

3.3 Reviews of key publications

This section gives very brief summaries of the purpose, general conclusions, and importance of the key publications (in rough chronological order) that have been used to compile this report. Technical and numeric conclusions are not, in general, given in this section but are referenced from later sections of this report where appropriate.

3.3.1 Mitsubishi Heavy Industries, 2004; *Ship transport of CO₂, IEAGHG Report No. PH4/30*

This is an early study conducted for the IEAGHG R&D Programme. It follows from Mitsubishi's patent (Mitsubishi Jukogyo KK, 2002) on the use of LPG ships for CO₂ transport. The study establishes the general feasibility of ship transport for CO₂ as a pressurised cryogenic liquid. It gives a range of costs and their sensitivity to basic variables of transport distance, ship size, ship speed and CO₂ input pressure to the liquefaction system; generally intuitive relationships result.

The study compares the costs of shipping with pipelines concluding shipping may be more cost effective for longer distances and is more flexible, but additional CO₂ emissions become significant for the longer distances studied (up to 12,000km). It highlights that energy requirement for liquefaction is a significant cost element of a CO₂ liquid transport system. The report discusses the idea of dual use of shipping with LNG transport on the return leg; however, this is not favoured.¹

3.3.2 Svensson *et al*, 2004; *Transportation systems for CO₂ – application to carbon capture and storage*

This paper gives an early comparison of costs of transport by rail, pipeline and shipping in the European context, including brief mention of the opportunities of EOR in the North Sea. For offshore transport at larger scale it concludes that pipelines and shipping have similar costs but different niches of applicability, suggesting both should be involved in a developing European CO₂ transport infrastructure. However, the analysis does not include costs of compression or liquefaction, which rather limits its value.

¹ This concept has since been developed in some detail by Aspelund and co workers and reported in a series of 2009 papers: *A liquefied energy chain for transport and utilization of natural gas for power production with CO₂ capture and storage – Parts 1 to 4*, see bibliography. These have not been reviewed in detail for the current report.

3.3.3 Hegerland, Jørgensen and Pande, 2004; *Liquefaction and handling of large amounts of CO₂ for EOR*

This paper, presented at the GHGT-7 Conference, is the first, and one of the few, papers found specifically focussed on EOR. Although Norwegian, the authors appear to be independent from the SINTEF/STATOIL project reported by Aspelund and co workers; Jørgensen is from Yara International (major ammonia producer). It gives the only firm figure found to date for the existing European market for liquid CO₂ (3 Mt/yr, of which 2 Mt/yr in food and drinks industries) and describes Yara's existing CO₂ shipping operations.

The paper gives a succinct description of the technical considerations for CO₂ liquefaction processes and shipping (it would be a good introductory read), setting out some of the options generally in line with those covered in other work. It concludes that the technology required is proven and can be modified to handle the quantities necessary for CCS and EOR. Notably, it is one of the few publications to mention a need for buffer storage of CO₂ at the receiving point of the ship transfer; however, it does not give any details.

3.3.4 Doctor *et al*, 2005; *IPCC special report on carbon dioxide capture and storage: Chapter 4 – Transport of CO₂*

This book chapter covers all modes of CO₂ transport at a fairly high level with the information on shipping being largely based on the Mitsubishi Heavy Industries (2004) report plus some personal communication from STATOIL. It gives some cost comparisons but not in as much detail as other publications. However, it has useful brief sections on regulation and risks of CO₂ transport. Overall, the chapter concludes that ship transport of CO₂ is feasible and should be considered for longer distance or lower volume cases where it may be competitive with costs of pipelines.

3.3.5 Aspelund, Mølnevik and de Koeijer, 2006; *Ship transport of CO₂: technical solutions and analysis of costs, energy utilization, exergy efficiency and CO₂ emissions; plus associated conference papers*

This paper is the main peer-reviewed publication arising from the SINTEF/STATOIL project mentioned above, several presentations at the GHGT-7 conference were based on aspects of the same work (Barrio *et al*, 2004, Aspelund *et al*, 2004a,b).

The paper gives a good, brief introduction to the issues and experience up to that time of CO₂ transport by ship. It gives a clear, understandable, explanation of the reasons for using semi-pressurised ships for CO₂ and for the pressure and temperature conditions required. It proposes, and explains clearly, an open cycle liquefaction process with some comparisons of process options, but without fully explaining why this preferable to using external refrigeration. The proposed process is the subject of one of two patents arising from this project (Aspelund, Krogstad and Sandvik, 2008). It also gives a detailed explanation of one possible novel offshore unloading system (subject of the second patent: Aspelund *et al*, 2008) but does not cover alternatives, and assumptions about rate of offload/injection are not necessarily optimal.

The paper describes analysis of energy use and cost estimates for the ship-based CO₂ transport system. It gives a useful breakdown of the elements of the system showing the clear dominance of compression in the liquefaction process as the main energy requirement and

cost element. However, it generalises the cost estimates to a range (23-30 USD/t-CO₂) and does not give specific transport distances ('North Sea distances').

Despite its drawbacks, this paper is important for the level of technical detail it gives and for its clarity of explanation; it has been drawn on extensively in the technical sections that follow.

3.3.6 Aspelund, 2010; *Developments and innovation in CCS technology: Chapter 12 – Gas purification, compression and liquefaction processes and technology for CO₂ transport*

This is a useful review chapter dealing with the processes required for liquefaction and conditions for ship transport alongside processes for conditioning for pipe transport. It draws mostly on Aspelund and colleagues' earlier work but brings it all together clearly and in a more balanced way, including coverage of alternative process options.

It gives a good overview of the processes involved, breaking them down to unit operations, with reasonable detail of process equipment and duties for each. A fairly clear logic flowchart shows process options depending on available cooling medium temperature, impurity levels in CO₂ and transport method. Process flowcharts are given for some example options.

The chapter quantifies the sensitivity of energy requirement for the conditioning process options to CO₂ inlet pressure, cooling medium temperature, and 'volatile' gas impurity level (as nitrogen). It observes that conditioning processes for ship transport generally require roughly 20% more energy than those for pipeline processes and gives a 'rule of thumb' derived from this as liquefaction processes being 30% more expensive than compression processes; other than this it has little on costs. There is only a short section in the chapter on transitions from pipeline to ship and *vice versa* and there is no other coverage of shipping details other than on selection of CO₂ conditions for ship transport.

3.3.7 Omata, 2011; *Preliminary feasibility study on CO₂ carrier for ship-based CCS; plus other Chiyoda Corporation reports for GCCSI*

This publication reports on a study by the Chiyoda Corporation (a large Japanese engineering company), supported by GCCSI. It covers the technical and economic feasibility of a concept for CO₂ transport using a carrier ship with injection equipment on board, to deliver directly to a sub-sea injection wellhead. It argues that in regions, such as Eastern Asia, where bulk resources are frequently traded long distances internationally by sea, it makes sense to consider the same for CO₂ transport.

The study considers intermediate storage, ships and the offloading buoy system, giving reasonable detail of design data and estimated costs. It also references detail and costs of the liquefaction system and some aspects of the wellhead equipment. Costs are based on two transport distances and a fairly small scale, 1 Mt/yr, giving costs greater than European studies reviewed. The report covers in some detail the proposed shuttle shipping system and submerged offloading system, involving a flexible riser with a pick-up buoy; it also gives limited consideration to an alternative offloading system. Occasional mention of possibilities of EOR is made but without any detail.

The report is interesting in that there are some different ideas presented, suggesting there may be different optima than proposed in the European studies reviewed; specifically different

temperature and pressure conditions for transport (although these are not clearly justified), different tank shapes (bi-lobe cylinders) and a different offloading system.

Two follow-up reports add little to the initial report. One extends the offloading conditions to those of a more remote site offshore Japan with harsher sea conditions (Omata, 2012a). The second (Omata, 2012b) is mostly concerned with offshore storage site identification.

3.3.8 Vermeulen, 2011; CO₂ Liquid Logistics Shipping Concept (LLSC) – overall supply chain optimization; and other Vopak-Veder CO₂ LLSC reports for GCCSI

This important report is part of the output from the Rotterdam CCS Network Project. It was prepared by Dutch consultants Tebodin for the logistics company Vopak and the shipping company Anthony Veder, with support from GCCSI. Associated publications are a safety, health and environment report (ter Mors, 2011) incorporating a separate safety study by Det Norske Veritas (DNV) (Koers and de Looij, 2011) and a report on the LLSC business model (Tetteroo and van der Ben, 2011). Other output from the project is not publically available.

The report is large (>140 pages) and detailed; it has been used as the principal source for much of the present literature survey. It is arguably the best source of published information on several aspects of a ship-based CO₂ transport system including, upstream network (by pipeline or barge), network flexibility, all stages of processing (with details of equipment duties and options), ship design, loading/offloading operations and equipment, and injection operations. However, it presents information on costs as indexed rather than actual costs, presumably for reasons of commercial sensitivity, making this aspect less useful.

The main and associated reports also have useful sections on materials of construction, carbon footprint, risk assessment and operational safety, which have been drawn on for the present survey. Other sections such as business model and growth scenarios are specific to the project and less appropriate to the present purpose.

Overall the report establishes that a liquid CO₂ ship-based transport system, as part of a wider logistics network, is feasible. It does not highlight any insurmountable technical issues, although it suggests that more development would be useful for offshore offloading systems where suitable options are limited. The project included provision of a CO₂ supply for EOR as one objective but, while much of the report is relevant, little is focussed on EOR. Specifically the issues of injection for EOR are not covered in detail beyond noting that continuous injection may require provision of offshore storage, or alternating offloading of two or more ships.

3.3.9 ZEP, 2011; The costs of CO₂ transport

This useful report forms part of a series addressing costs of all elements of the CCS chain. It gives a stepwise analysis of costs of CO₂ transport by pipeline and shipping giving a good account of costs sensitivities. It is based on members' data and experience and claims to give cost estimates with a $\pm 30\%$ accuracy. While it covers technical issues in outline this is not its main focus, however, some of the assumptions it makes to allow generalisation may lead to underestimated costs compared to any specific project.

3.3.10 Giles, 2012; *Peterhead CO₂ importation feasibility study report*

This report, prepared by Petrofac Engineering Ltd. for CO₂DeepStore, makes only a limited contribution to the present survey as it considers only one end of a liquid CO₂ supply chain: receipt of CO₂ into Peterhead port or direct to offshore. It is also largely constrained by the objective of evaluating re-use of existing infrastructure. It covers technical aspects at a fairly high level in terms of assumptions made for specific scenarios without more general discussion. However, it does outline an alternative offshore mooring system and lists some capital costs of offshore elements. It also reports on a hazard identification study.

3.3.11 Roussanaly, Bureau-Cauchois and Husebye, 2013; *Costs benchmark of CO₂ transport technologies for a group of various size industries; and other papers from the COCATE project*

A project studying collection of CO₂ in the Le Havre area, the COCATE project, has led to this paper and a number of other publications (Decarre *et al*, 2010; Roussanaly, Hognes and Jakobsen, 2013; Roussanaly *et al* 2013) covering similar ground. These are the most recent European publications in the field; however, their technology sections refer largely to previous publications reviewed above, notably from Aspelund and co-authors.

This paper compares costs for CO₂ transport by ship or by onshore pipeline between Le Havre and a hub at Rotterdam, with the concept of onward transport for storage or EOR from there. It concludes the difference is not large, shipping costing around 10% more. It gives some useful breakdown of transport costs for the different systems that help explain cost sensitivities and some discussion of effects of implementation strategies that may favour shipping in the shore term.

3.3.12 Yoo *et al*, 2013; *Development of CO₂ terminal and CO₂ carrier for future commercialized CCS market*

This paper and a related conference paper (Yoo *et al*, 2011) are somewhat derivative of others (notably ZEP, 2011) but extend the argument to the Korean context and give another example showing that shipping can be competitive with pipelines under the right conditions. They extend the concept, however, in proposing much larger CO₂ carriers of up to 100,000 m³ and storage barges of 110,000 m³, which may allow shipping to be competitive at the larger scales of commercial projects.

3.3.13 Whittaker and Perkins, 2013; *Technical aspects of CO₂ Enhanced Oil Recovery and associated carbon storage*

This GCCSI report gives a relatively non-technical introduction to EOR in general. It has nothing specific on transport of CO₂, although it mentions the Chiyoda/GCCSI report on shipping (Omata, 2011). It suggests the CO₂ demand profile for any single EOR development would be fairly constant for most of its lifetime before tailing off. However, it also describes injection profiles that may lead to intermittency in short-term CO₂ requirement.

4 Technology for CO₂ shipping

The technology required for a CO₂ transport system based on shipping can be adapted directly from that used for other liquefied gases, notably LPG (Mitsubishi Heavy Industries, 2004). However, there are some different considerations and opportunities owing to the phase behaviour of CO₂ that affect the process details. This section is subdivided into the elements that make up a potential CO₂ supply chain using ship transport.

4.1 Liquefaction

For any transport mode CO₂ should be in a dense form, not gaseous, to be cost-effective. This is achieved by increasing pressure and/or reducing temperature to bring CO₂ into a dense phase – either liquid or super-critical fluid.² The cost of pressure vessels increases with the pressure to be contained, as well as with size, so for shipping it is most cost-effective to liquefy CO₂ using a moderate pressure and low temperature.

Most authors recommend conditions near the triple point (5.2 bara, -56.5°C) for shipping of liquid CO₂; Aspelund, Mølnevik and de Koeijer (2006) recommend a pressure of 6.5 bara and temperature of -52°C giving sufficient margin from the triple point to avoid risk of solid CO₂ formation in normal operation. To achieve these conditions, CO₂ is liquefied by a combination of compression and cooling. There are different process options available, the choice depending on temperature of available cooling water and on availability/desirability of an external refrigeration system (e.g. using ammonia). Aspelund (2010) gives a clear explanation of the process options, including steps for dehydration and removal of impurities.

In outline, CO₂ is compressed to 35 bar in several stages, with inter-stage cooling; dehydration is by condensation at cooling stages followed by duplex regenerative adsorption columns to achieve <50 ppm water content. CO₂ is then liquefied either by condensation using an external refrigeration system, or by over-compression to 100 bar and expansion to 60 bar (resulting in cooling and condensation), or by compression and cooling against cooling water (or seawater) at <15°C in a heat exchanger to condense the CO₂. The liquid is then distilled to remove 'volatiles' (impurity gases such as nitrogen and argon) before expansion to storage pressure of 6.5 bara, resulting in cooling to -52°C. The CO₂ that flashes off during this final expansion is recycled to the appropriate pressure stage in the initial compressor train.

The energy requirements of these process options differ. Aspelund (2010) gives figures for comparable model cases showing requirements ranging 110 to 123 kWh/t for the three options, the lowest using seawater cooling. A comparison with energy for compression to pipeline conditions is also given, showing liquefaction processes need 11-14% more energy for comparable purification duty and service availability.

These three liquefaction process options described are the subjects of a patent application (Aspelund, Krogstad and Sandvik, 2008) with priority date (in UK) of 16/07/2004; the status of this application has not been checked. No mention of IP constraints by other authors have been noted. More recently, other authors (Lee, Yang *et al*, 2012) have proposed further process variants claiming reduced costs.

² A basic understanding of the phase behavior of CO₂ is assumed. See Aspelund (2010), Section 12.2, for a brief, readable explanation if required.

Many publications do not debate liquefaction process options, focussing instead on a single process, which may be selected for local cooling service availability or corporate experience, but without clear justification. The conditions for ship transport proposed in most cases are the same as or close to those mentioned above (6.5 bara, -52 °C); however, one study, which optimised conditions over an entire model transport chain, including pipeline sections and intermediate storages concluded the 'global' optimum conditions were 10 bara and -39 °C (Nam *et al*, 2013).

4.2 Intermediate storage at loading point

CO₂ capture and liquefaction are continuous processes, whereas ship transport of liquid CO₂ is a discrete, batch process. Hence there is a need to provide buffer storage holding at least the volume of a ship, to minimise time for loading and the unproductive time a ship spends in port. Storages for liquid CO₂ exist for the current trade and storage can be scaled up using existing technology based on LPG. Tank configurations can be spheres or cylinders ('bullet tanks') each having various pros and cons; Vermeulen (2011) gives a detailed discussion of the comparison concluding that total installed cost of spheres will always be lower for the same volume, but that the difference was small and often other factors would override the cost advantage. Current construction trends are for more cylinders and most other publications assume use of cylinders.

The size of intermediate storage should be at least the same as ship volume to ensure the ship can be loaded in minimum time. The size factor proposed varies between authors, ranging from 1.0 (ZEP, 2011) times to 1.5 times (Berger, Kaarstad and Haugen, 2004; Barrio *et al*, 2004). This is discussed by Yoo *et al* (2013) who conclude a factor of 1.2 times ship volume is sufficient, based on experience operating a liquefied natural gas (LNG) shipping system. They propose a floating barge storage system for use where space is limited onshore, describing a conceptual design using horizontal cylindrical tanks for lower volume storages, or vertical tanks for larger storages with total capacity up to 110,000 m³.

Some authors (e.g. Svensson, 2004a,b; Aspelund, Mølnevik and de Koeijer, 2006) have mentioned the potential use of underground rock caverns for intermediate storage, analogous to their use for natural gas storage, but this idea has not been developed in detail.

4.3 Ship loading

Assuming normal port facilities are available, liquid CO₂ can be loaded onto ships using a conventional articulated loading arm developed for other cryogenic liquids such as LPG and LNG. An alternative would be to use a flexible cryogenic hose but this is considered to be less reliable with higher risk of failure and leakage (Vermeulen, 2011). Cryogenic pumps located near the storage transfer the liquid CO₂ *via* an insulated pipeline, specified for the liquid storage conditions, to the loading arm and the ship. A second line returns gas from the empty ship's tank, and any boil-off gas produced on loading, to the compressors of the liquefaction plant. Loading rates can be quite high allowing ships to be loaded within a day, for example Vermeulen (2011) proposes using two loading arms to fill at a rate of 2875 t/h allowing a 30,000 m³ ship to be filled within 12 h.

4.4 Ship design

4.4.1 Existing experience

Existing experience in liquid CO₂ shipping is limited to a small fleet of small ships used in the European trade of CO₂ for industrial uses. The total European trade volume in CO₂ as an industrial gas is around 3 Mt/yr, mostly (2 Mt/yr) in the food and drinks industry (Hegerland, Jørgensen and Pande, 2004). Much of this is derived as a co-product of hydrogen production by the major industrial gas suppliers and is generally transported by truck or train overland. A significant quantity is produced as a by-product of ammonia manufacture (also at the stage of hydrogen production).

The ammonia producer Yara International trades much of its CO₂ by-product and transports it by sea from production sites in Norway and the Netherlands to seven import and distribution terminals around western European coasts. Of their original fleet of four tankers³, three are now operated by Larvik Shipping: Yara I and II, at 900 t each, and Yara III, 1200 t (Larvik, 2014). Yara themselves have two recently reconditioned LPG tankers for CO₂ transport, Yara Embla and Yara Froya, each carrying 1800 t (Yara, 2013). All these ships are rated for higher pressures than discussed above, they carry CO₂ at 15-20 bara and around -30 °C.



Figure 4. Examples of existing CO₂ and dual-purpose LNG/CO₂ carriers

The Dutch shipping company Anthony Veder also operates one 1250 m³ CO₂ tanker rated for 18 barg and -40 °C (Anthony Veder, 2014). This is variously listed as a LPG tanker, so is

³ Several sources mention four Yara ships prior to the reconditioning of the two larger ships, however, no information on the fourth smaller tanker has been found.

probably dual purpose. This ship carries CO₂ for the Linde group, mainly in the Baltic. The operator may have other dual-purpose LPG tankers in use for carrying CO₂. (Heucke, 2014)

Beyond this, the shipping company IM Skaugen has six 10,000 m³ ships in their fleet which are rated to 7 bar, -104 °C, and are registered for carrying liquid CO₂, however, their normal cargo is LPG. The company has been involved in CCS project development but it is not clear if the ships have been used yet for CO₂ transport (IM Skaugen, 2014).

4.4.2 Proposed ship designs

Ship transport of liquid CO₂ is covered by the International Code for the Construction and Equipment of Ships Carrying Liquefied Gases in Bulk (IGC code) (IMO, 2014), which covers other liquefied gases such as ethylene, ammonia, LNG and LPG. Proposed designs for liquid CO₂ ships are based on experience from the large fleet of LPG tankers currently operating, put at >300 by ZEP (2011).

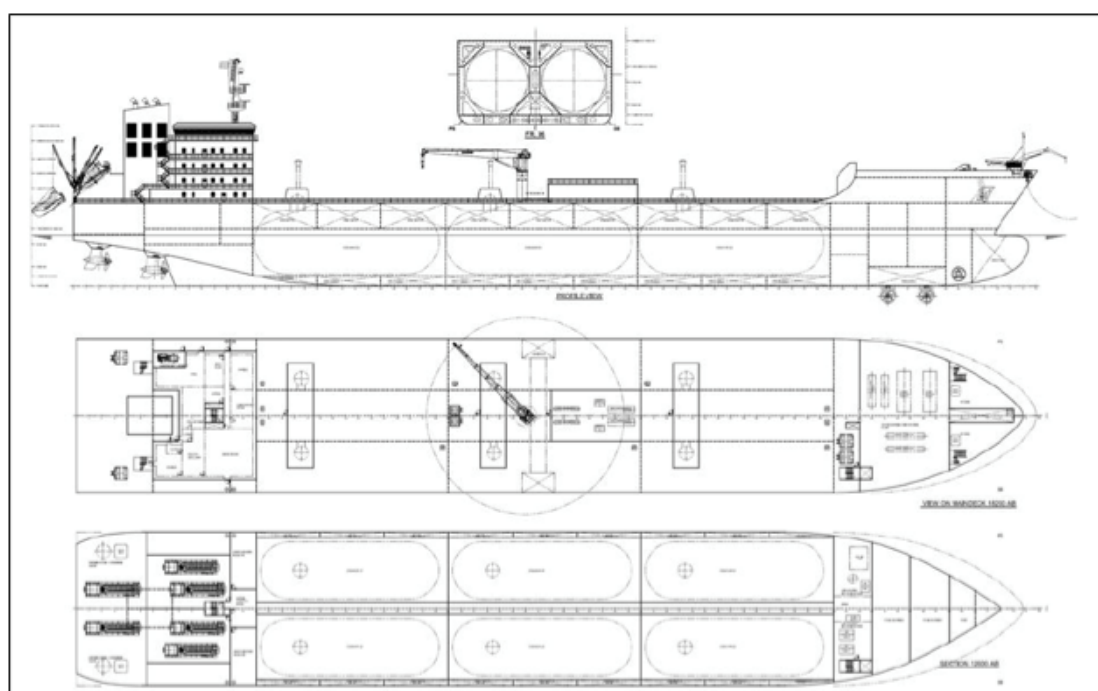

Figure 5. General arrangement for proposed 30,000m³ CO₂ carrier, conventional design (Vermeulen, 2011)

Proposed designs (e.g. Vermeulen, 2011; Yoo *et al*, 2013) typically employ a number of cylindrical tanks of 3-6,000 m³ capacity, arranged in pairs horizontally, aligned fore and aft, to give a total cargo capacity of 20-40,000 m³ as shown in Figure 5. Variants on this include the shape of the tank and the arrangement of tanks. Alternative tank shapes considered include bi-lobe cross-section (Omata, 2011) or spherical (Ozaki, Davison and Minamiura, 2004). Arrangements of cylindrical tanks considered include one smaller above two larger, the X-Bow design, Figure 6 (Vermeulen, 2011) or vertically arranged cylinders allowing close-packing of tanks in designs of ships up to 100,000 m³ capacity, Figure 7 (Yoo *et al*, 2011 and 2013).

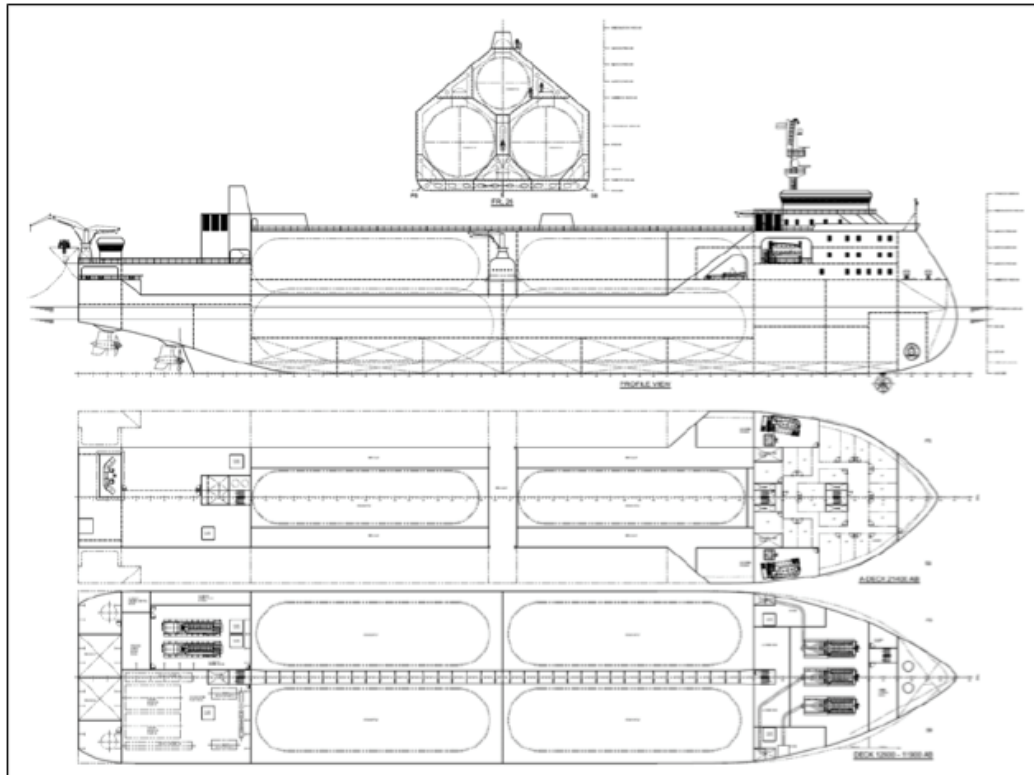

Figure 6. General arrangement of proposed X-Bow design 30,000m³ CO₂ carrier (Vermeulen, 2011)

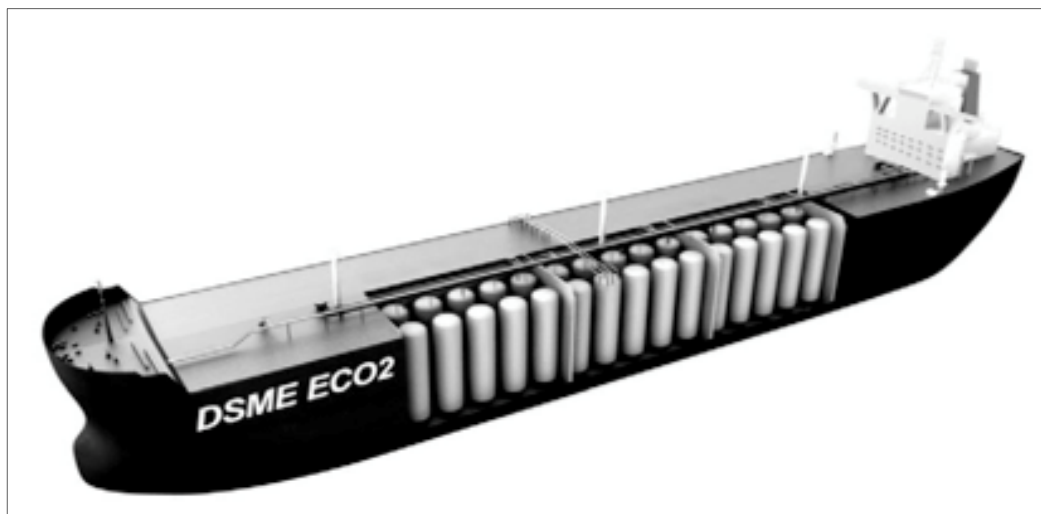

Figure 7. Conceptual drawing of 100,000m³ very large CO₂ carrier (Yoo *et al*, 2013)

The proposed designs for tank insulation, double walled cargo holds and tank fixing are as used for LPG tankers and not discussed in detail in most of the publications reviewed, reasonable detail is given by Omata (2011). The requirement of a Dynamic Positioning System (DPS) to maintain the ship's position at the point of offshore offloading is assumed in all cases. Some considerations of the DPS requirements are given by Vermeulen (2011) and Omata (2011).

Most publications show conventional tanker designs for CO₂ carriers with bridge and accommodation block aft. The X-Bow arrangement, offered as an alternative by Vermeulen (2011), has these on the bow section; the design has a number of advantages but these are outweighed by concerns over the reliability of using an offloading system sited at the stern of the vessel, requiring an astern approach upwind to the offshore offloading point.

One publication reviewed (Haugen *et al*, 2009) outlines potential transport of compressed CO₂ in vertically arranged pressure cylinders. This reduces the effective density for transport but benefits from avoiding the need for liquefaction. The paper implies several companies were developing the concept, however, no further references were found.

4.5 Ship offloading

Most of the publications reviewed assume offshore offloading to an injection well *via* some form of single point mooring (SPM) system to either a platform or a subsea wellhead connection. In a few cases offloading to shore is considered, discussed first below.

4.5.1 Offloading to shore

A few reports consider offloading from ship to a shore-based facility, optionally with intermediate storage, before accessing the injection well by pipeline (Giles, 2012; Yoo *et al*, 2013; ZEP, 2011). Giles (2012) gives various options for offloading equipment, however, these are constrained by the desire to reuse existing infrastructure at Peterhead port so are not typical.

Vermeulen (2011) also describes offloading from barges used for collection of CO₂ *via* inland waterways to a coastal transport hub, with access to an injection site by either ship or pipeline. Some detail of offloading is given using pumps on the barge to transfer liquid CO₂ *via* a conventional loading/unloading arm to liquid storage tanks, with a return line for pressure equalisation and a link to the boil-off gas handling system in the terminal. Typical ship offloading designs would have similar capabilities.

4.5.2 Offshore offloading

There are two key aspects of offshore offloading of CO₂ for injection for either EOR or geological sequestration:

- the change in CO₂ conditions necessary between ship transport and injection well;
- the physical connection between ship and well.

These are reviewed below in turn.

The transition from ship transport conditions (about 7 bara, -50 °C after voyage) to conditions necessary at the wellhead will vary depending on the reservoir conditions and so is specific to each injection site, however, heating and pumping to high pressure will always be required. A detailed account of the considerations needed to calculate the required wellhead conditions is given by Vermeulen (2011) and this area is dealt with more briefly by Aspelund, Mølnevik and de Koeijer (2006). Wellhead conditions determine the conditions that will result at the bottom of the injection well. Bottom-hole conditions must overcome the reservoir pressure and avoid risk of blockage of access to the reservoir through solid hydrate or wax formation. This requires temperatures greater than 15 °C at the bottom of the injection well and in the

reservoir inlet zone; in turn, this needs the temperature at the wellhead to be around ambient, although ranging -15 to +20 °C depending on the pressure requirement. The pressure depends on the specific well conditions and is affected by degree of maturity of the reservoir in terms of CO₂ injection; wellhead pressures ranging 50-400 bar are discussed.

The upshot of this is that liquid CO₂ needs to be pumped to high pressure and heated in the transition from ship to well. Most authors propose that at least some, if not all of this duty is performed on the ship, to avoid difficulties of transferring cold liquid through a flexible pipe connection at or under sea. Examples of heating and pumping systems are given by Aspelund, Mølnevik and de Koeijer (2006), by Omata (2011) and in most detail by Vermeulen (2011). Vermeulen proposes deep-well pumps to deliver liquid CO₂ from each cargo tank to deck level, a low-pressure pump (45 barg) to avoid vaporisation on warming the CO₂, a shell and tube heat exchanger using seawater to raise the temperature to -8 °C before high-pressure centrifugal pumps boost the pressure to 154 to 400 bar and raise the outlet to the temperature required, in this case 0 °C, through pump inefficiency, see Figure 8. To avoid the use of high pressure transfer lines, Aspelund, Mølnevik and de Koeijer (2006) suggest using only one booster pump on the ship, delivering 60 bar to the heat exchanger, with additional pumping to injection pressure taking place on the platform.

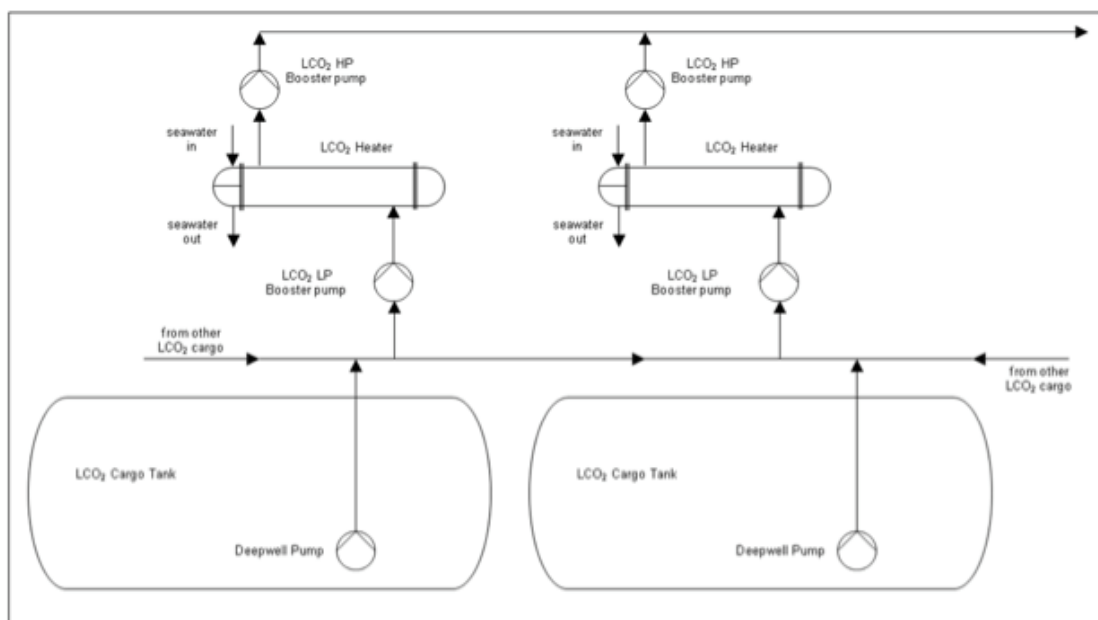

Figure 8. Proposed discharge equipment on ship (Vermeulen, 2011)

Depending on the wellhead temperature required by the specific case, and the seawater temperature of the location, additional heating might be necessary. This may be provided by waste engine heat on the ship (Omata, 2011), waste heat if available on the injection platform, or a fuelled heating system, the latter having implications for cost and additional emissions (Aspelund, Mølnevik and de Koeijer, 2006).

In addition to the heating and pumping systems, Vermeulen (2011) also suggests the provision on ship of a small vaporisation unit to supply gaseous CO₂ to replace the tank volume on discharge of liquid CO₂, and a dry compressed air unit to keep the cargo holds (space between hull and tanks) dry.

Considering the physical connection of ship to injection point *via* the mooring system, there are several variants of SPM suggested. These are all based on existing hydrocarbon transfer systems with no clear consensus on what is most appropriate for CO₂; however, the best system for any situation will most likely be specific to the location.

Omata (2011) proposes a Submerged Loading System (SLS) using a flexible riser pipe connected through a fixed pipe section to a subsea injection template, Figure 9. The flexible riser remains on the seabed when not in use and is retrieved from the ship using a buoyed messenger line and pick-up wire. The report gives extensive details of the technology, the operations involved and the sea conditions for which it is suitable. The location described in the report is offshore SW Japan with a water depth up to 500m. A second report (Omata, 2012a) extends the proposal to a location offshore NE Japan where sea conditions are more severe.

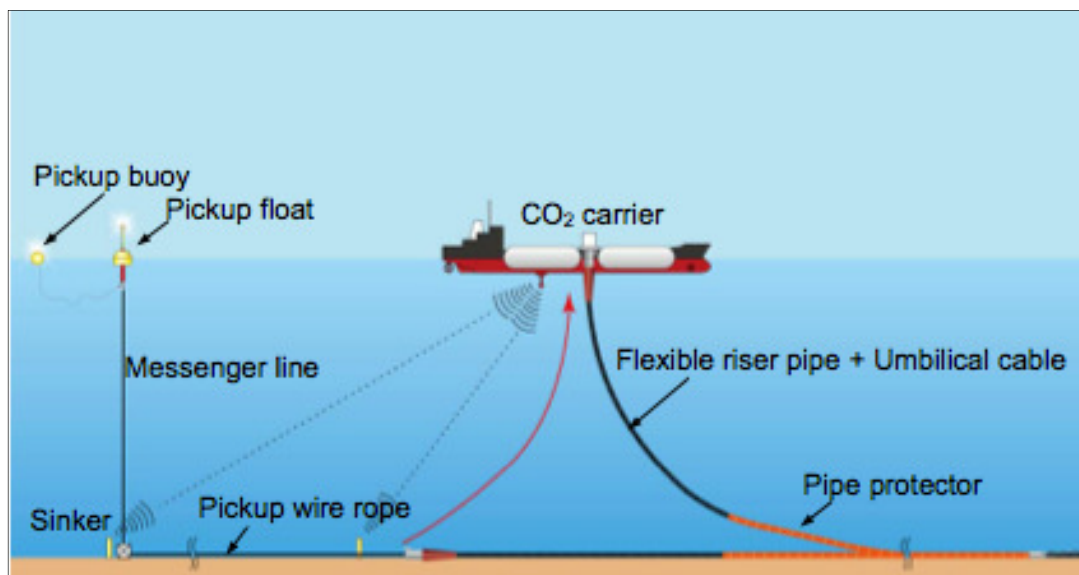

Figure 9. Submerged loading system, subsea injection template not shown (Omata, 2011)

Aspelund, Mølnevik and de Koeijer (2006) propose a Submerged Turret Loading (STL) system as developed for Floating Production and Storage Offshore (FPSO) systems (NOV/APL, 2014). This comprises a semi-submersible buoy that is brought up into a well inside the hull of the ship, allowing connection through the buoy to a flexible riser and *via* a fixed seabed pipeline to an injection platform, Figure 10.

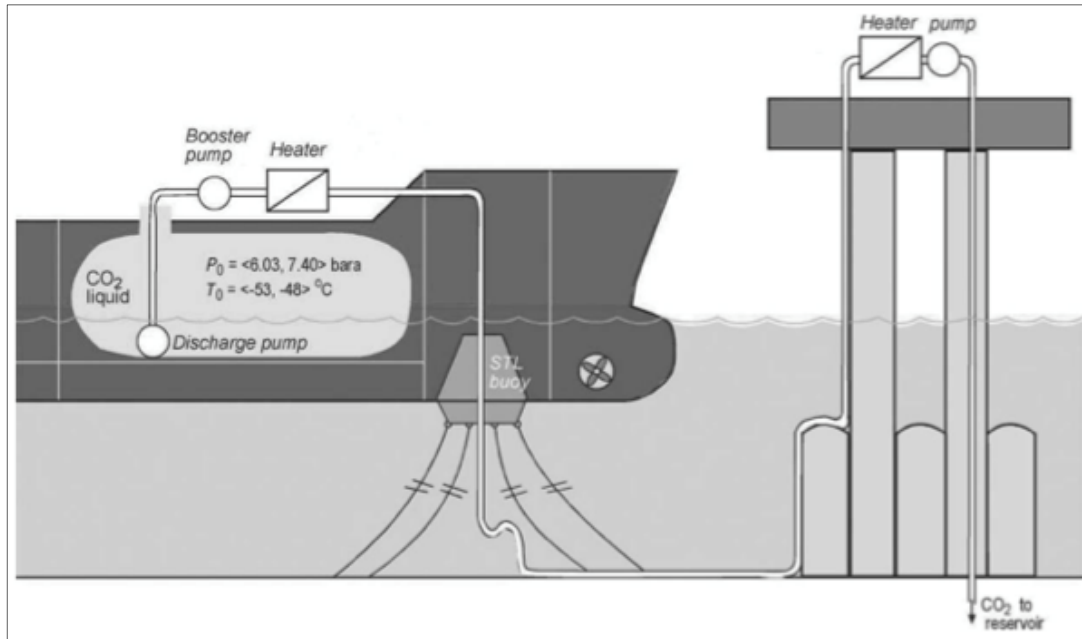

Figure 10. Sketch of submerged turret loading system (Aspelund, Mølnevik and de Koeijer, 2006)

Vermeulen (2011) considered four different SPM systems: a Submerged Loading System (similar to that described above), a Fixed Tower SPM (FTSPM), a Single Anchor Leg Mooring (SALM) and a Conventional Buoy Mooring (CBM); all were considered feasible for the location studied (Southern North Sea). The CBM was thought likely to have high down time, due to its limitation on operation in high sea states. The SALM has a relatively high risk of damage through collision, so was not favoured.

For the location studied in the Southern North Sea with moderate depths (26.5m) Vermeulen (2011) considered the FTSPM (Figure 11) as the only system that could be recommended, although suggesting the SLS may be possible with further analysis (the water depth may be too shallow for the bending capability of the flexible pipe). A floating version of the FTSPM (Floating Loading Platform) is also available for water depths >80m. The FTSPM system uses a tower fixed to the seabed with a rotating head incorporating an offloading boom. The ship is moored to the tower by hawsers and a suspended flexible pipe conducts CO₂ to the tower. Fixed pipes conduct CO₂ via the boom, tower and seabed to the platform riser. Vermeulen (2011) gives details of the mooring and offloading operations; valves and relief provision for both normal operations and emergency situations are also described. The main reason given for favouring the FTSPM system is its reliability, allowing high utilisation rates in the location studied.

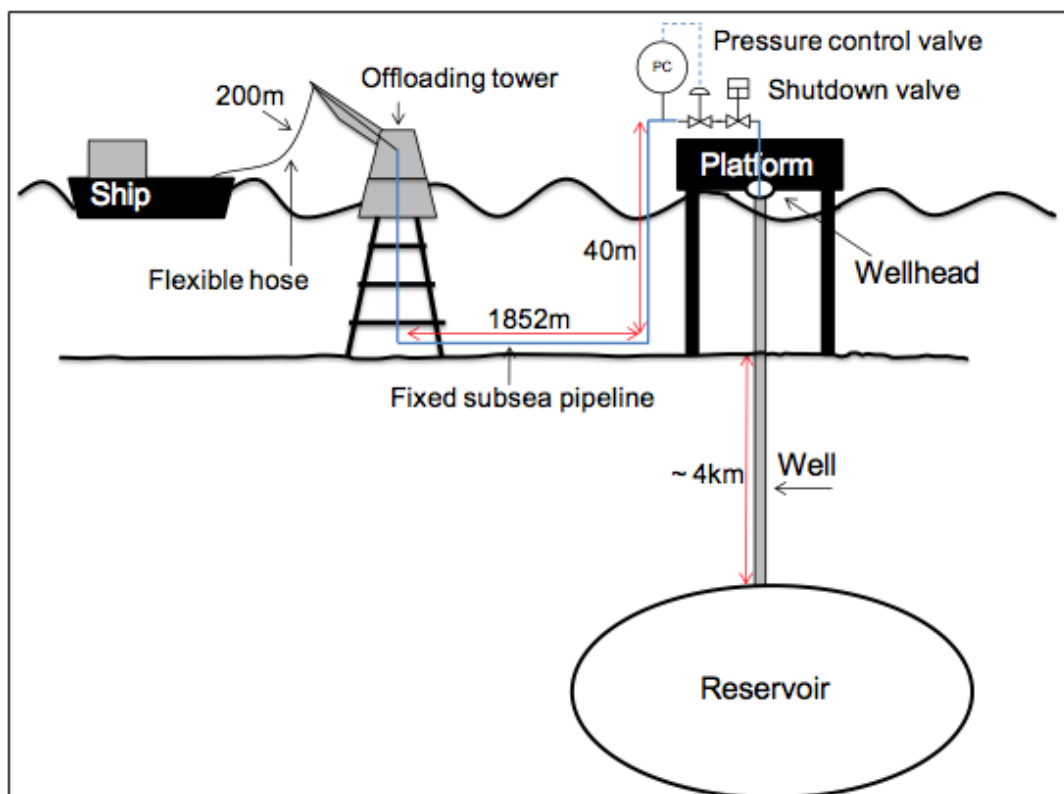

Figure 11. Fixed tower single point mooring offloading to platform (Vermeulen, 2011)

4.6 Injection

Most publications concerning ship transport of CO₂ set the boundary of their study upstream of CO₂ injection and make assumptions of conditions for delivery of CO₂ for injection based on other literature. Vermeulen (2011) modelled the injection process for a specific target well to determine the temperature and pressure conditions for transfer from ship to well (as discussed in Section 4.5.2 above) and to study the flow characteristics and operational constraints of injection. The detail is beyond the scope of this report but is summarised here.

Vermeulen (2011) concluded that, if possible, wells should be sized, or increased in number, to ensure the required design flow into the reservoir could be achieved under gravity-dominated flow in the well(s). This would avoid issues of vibration/pulsation and have a lower pressure drop compared to friction-dominated flow, hence keeping pump size and energy requirement to a minimum. However, the flow rate modelled in the study (449 kg/s split over three wells) was based on unloading the CO₂ cargo in 24h; at that rate the flow would be friction-dominated in the well.

Operational issues discussed by Vermeulen (2011) included initial injection into a low pressure reservoir plus the issues of 'shut-in' (between deliveries of CO₂) and shutdown, planned or emergency. For initial injection to a low-pressure reservoir, if the CO₂ has been warmed to avoid hydrate formation in the reservoir, two-phase flow in the well can be expected and should be designed for. To avoid two-phase flow in ship transfer lines a pressure control valve should be installed at the wellhead and pressure in the lines should be sufficient to maintain supercritical phase. The study predicts that when injection is stopped, such as when waiting for the next shipload, pressurised CO₂ in the well will expand quickly

into the reservoir resulting in cooling to as low as -60 °C with risk of hydrate and dry-ice formation. This might be avoided by a controlled ramp-down of flow rate as the injection batch is completed. However, in emergency shutdown conditions such low temperatures and rapid temperature changes should be anticipated and equipment designed accordingly.

A detailed modelling study of injection of liquid CO₂ at optimum transport conditions (7-8 bar, -53 °C) has been made by Krogh, Nilsen and Henningsen (2012) who concluded this was not advisable due to risk of hydrate formation and freezing in the reservoir. Other than warming as discussed above, they propose alternative transport conditions as a solution, suggesting that reduced energy requirements of liquefying at 20 bar and -20 °C might offset the loss of shipping efficiency resulting from reduced density of CO₂ in these conditions. This chimes with the finding of Nam *et al* (2013) mentioned above (Section 4.1).

It is notable that there is limited discussion of injection rates in the literature, and none found that relates to injection rates specifically for EOR. Rates quoted range from 52 L/s (Omata, 2011) to 449 kg/s (Vermeulen, 2011) (approximately 200 to 1600 t/h). In most cases, injection rates where given or implied, are simply a function of the overall system design and defined by the annual capacity through the ship size and required offloading time. But the injection rate achievable is clearly a function of individual reservoir conditions, and it appears that system optimisation should cover both transport and injection aspects together, not set a boundary at the wellhead.

5 Costs of CO₂ transport by ship

5.1 Shipping cost estimates

Many of the publications reviewed give information on estimated costs of CO₂ shipping, in several cases with comparisons to pipeline costs, onshore or offshore. However, model assumptions and what has been included in the cost estimates differ between studies making comparison between them difficult. A selection of data from some of the key publications reviewed is given in Table 1.

Table 1. Lifetime, whole system, specific costs of CO₂ transport by ship

Publication reference	Cost range	Unit	Distance or range, km	Main assumptions
Mitsubishi Heavy Industries, 2004	18 – 58	USD/t-CO ₂	200 – 12,000	30,000 t ship, 6.2 Mt/yr
Doctor <i>et al</i> , 2005 (quoting unpublished Statoil data)	42	USD/t-CO ₂	3,800	20,000 t ship, 5.5 Mt/yr
Aspelund, Mølvik and de Koeijer, 2006	20 – 30	USD/t-CO ₂	“North Sea distances”	20,000 m ³ ship, >2 Mt/yr
Omata, 2011	4.3 – 5.4	¥/kg-CO ₂	200 – 800	3,000 m ³ ship, 1 Mt/yr
ZEP, 2011 (demonstration projects)	14 – 20	EUR/t-CO ₂	180 – 1,500	≤ 40,000 m ³ ship, 2.5 Mt/yr
ZEP, 2011 (large-scale networks)	11 – 16	EUR/t-CO ₂	180 – 1,500	≤ 40,000 m ³ ship, 20 Mt/yr
Roussanaly, Bureau-Cauchois, and Husebye 2013	19	EUR/t-CO ₂	480	30,000 m ³ ship, 13.1 Mt/yr

These data, expressed as specific cost per unit of CO₂ transported, are for total lifetime costs of the ship transport system, including compression and liquefaction, CAPEX and OPEX; they are intended to give an indication of the range of costs as it is not practical to rationalise the data to a consistent basis. However, taking typical recent exchange rates and focussing on the lower shipping distances shows the values to be broadly similar.

The ZEP (2011) study, part of a series of reports addressing costs of all elements of the CCS chain, claims to be “the most complete analysis of transport costs to date”. It gives a stepwise analysis of costs with the intention of allowing the reader to modify assumptions for their own

estimates and it aims to be a reference work for CO₂ transport costs. Much of the primary cost data used in the analysis is derived from ZEP's members' in-house experience and the target accuracy for cost estimates is $\pm 30\%$. Roussanaly, Bureau-Cauchois and Husebye (2013) compared their work with ZEP's methodology, finding their own estimates some 20% higher. This was rationalised as due to different assumptions on shipping fuel costs and reconditioning pressure following shipping. While their benchmarking study falls within the range of accuracy claimed by ZEP, they make the point that details of specific projects may increase costs above those estimated by ZEP's reference work.

5.1.1 Cost breakdown

Most of the publications listed in Table 1 give a detailed breakdown of shipping costs, however, case specifics make the relative proportions of costs difficult to generalise. In all cases the cost of liquefaction is significant due to both capital costs and operating costs arising from high energy consumption (assuming input of CO₂ to the transport system at around atmospheric pressure); Aspelund, Mølnevik and de Koeijer (2006) estimate that liquefaction accounts for over 40% of the total transport system specific cost (Figure 12).

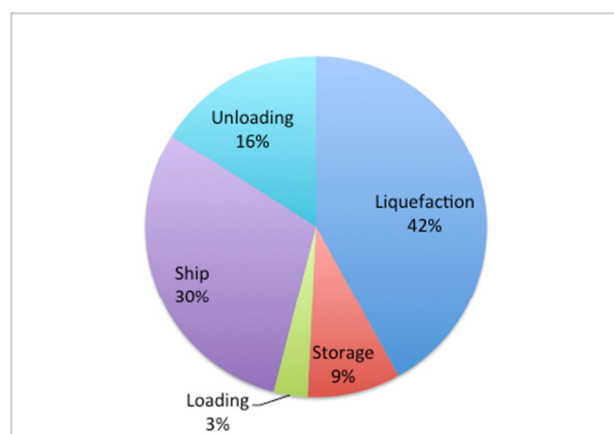

Figure 12. Breakdown of total ship transport system specific costs, from data in Aspelund, Mølnevik and de Koeijer (2006)

5.2 Comparison of shipping with pipeline costs

All the publications that compare the costs of pipeline transport with costs of shipping find similar trends, but the conclusions they draw differ markedly depending on the specific model assumptions made.

In general, pipeline costs depend mainly on capital costs, which are largely proportional to distance. They benefit from economies of scale and full utilisation. Offshore pipelines will always be more expensive than onshore. In contrast shipping systems have lower CAPEX and costs are less sensitive to distance and to scale. For any given scale the relationship between cost and distance transported will be something like that shown in Figure 13, with differing slopes depending on specific assumptions. (Doctor *et al*, 2005).

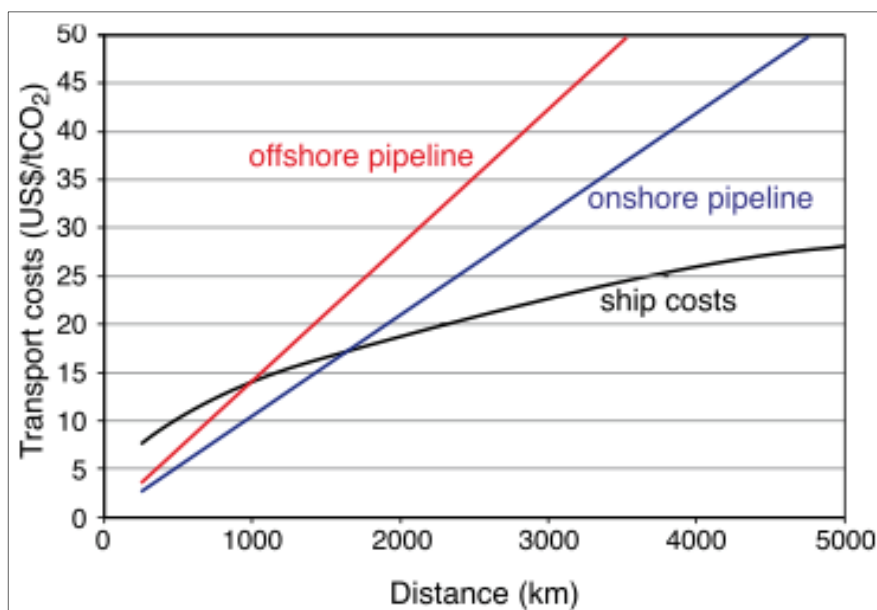

Figure 13. Comparison of costs of ship and pipeline transport of CO₂ (Doctor *et al*, 2005)

For short transport distances pipelines are less expensive than shipping, while for long transport distances shipping will generally cost less. The crossover point, or 'breakeven distance', above which shipping is more competitive than pipeline transport varies with the scale and other specifics of each case. Approximate breakeven distances for shipping *versus* offshore pipelines, including values for different scales where available, are given in Table 2, taken from the key publications reviewed that allow this comparison to be made.

Table 2. Approximate breakeven distances for ship transport of CO₂ vs. offshore pipeline costs.

Publication reference	Scale, Mt/yr	Breakeven distance, km
Mitsubishi Heavy Industries, 2004	6.2	700
	30	1,500
Doctor <i>et al</i> , 2005	6	1,000
Vermeulen, 2011	1 – 4	150
ZEP, 2011	2.5	300
	20	1,460
Yoo <i>et al</i> , 2013	10	300

While all studies conclude that there is a distance above which transport of CO₂ by ship becomes competitive with pipelines, this distance depends strongly on scale: shipping becoming competitive at shorter distances with smaller scales of transport. Clearly, however, other project-specific factors also affect the breakeven distance.

5.3 Cost sensitivities

Most publications with cost estimates deal to some degree with cost sensitivity, at least to the major parameters such as scale, transport distance, ship size and utilities costs; these are covered well by Mitsubishi Heavy Industries (2004) and Vermeulen (2011) among others. The effects of these parameters are fairly intuitive, although shipping costs are relatively insensitive to distance as discussed above. Assumptions made on financial parameters and project lifetime also clearly affect resulting cost estimates.

Sensitivity to some less obvious parameters has also been studied including: effect of available cooling water temperature (cooler – lower cost for liquefaction; Aspelund, Mølnevik and de Koeijer, 2006), ship speed (little effect) and CO₂ supply pressure (higher – lower cost; both Mitsubishi Heavy Industries, 2004), presence of impurities in CO₂ (higher – higher energy, hence cost; Aspelund, 2010).

ZEP (2011) analysed their estimates for the effects of capacity utilisation, transport distance and estimation error in CAPEX and OPEX for both offshore pipelines and ship transport. They found shipping most sensitive to errors in OPEX estimation, such as may result from changes in fuel costs or crew costs, while shipping costs were relatively insensitive to CAPEX errors, transport distance and utilisation rates as compared to pipeline costs.

This can be understood from the relative breakdown of costs, Figure 14, shown by Roussanaly, Bureau-Cauchois and Husebye (2013) for the comparison of costs between onshore pipeline and ship transport from a network at Le Havre to Rotterdam, a distance of 480 km. This shows the dominance of operating costs for shipping while the up-front capital costs are lower at about 60% of pipeline CAPEX. Note that the harbour fees allowed, which equate to the overall difference between cases, assume a value for CO₂ as a chemical product, these fees would be reduced if this were not so, bringing the two estimates to almost equal cost. In this study the use of an offshore pipeline was discounted after a preliminary study indicated it would be 30% more expensive than an onshore pipeline (Roussanaly, Bureau-Cauchois and Husebye, 2013); this implies the offshore pipeline case would be 18% more expensive than shipping in this example.

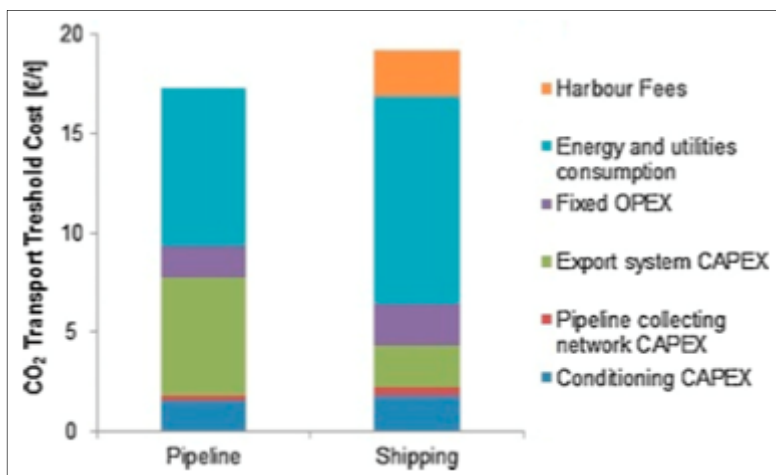

Figure 14. Cost breakdown of onshore pipeline and shipping supply chains between Le Havre and Rotterdam (Roussanaly, Bureau-Cauchois and Husebye, 2013)

5.4 Financial risk, asset flexibility

This difference in the up-front CAPEX requirements underlies one of the significant potential advantages of a ship-based CO₂ transport system over a pipeline system. Several publications (including Vermeulen, 2011; ZEP, 2011; Roussanaly, Bureau-Cauchois and Husebye, 2013) make the point that CCS deployment is most likely to ramp up in any given area over a number of years and that the flexibility of a shipping system may reduce financial risk to investors. This arises from the flexibility of shipping to collect from and deliver to different capture and storage sites and from the ability to increase transport capacity at relatively low capital cost by adding further ships to the system. A further advantage may arise from the capability of ships designed for CO₂ transport to carry LPG as an alternative cargo, meaning the ships can have an 'end of use' value. These points contrast with the fixed routes and 'sunk costs' of pipeline systems and may reduce the financial risks of a ship-based system making them more attractive to investors.

These advantages would seem to hold for CO₂-EOR where the flexibility of shipping could be useful in both the short term to satisfy requirement of an intermittent injection profile (Whittaker and Perkins, 2013) and in the longer term as different fields become ready for EOR techniques at different times.

6 Regulation and HSE aspects

Few publications within the bibliography on CO₂ shipping refer to regulatory or health, safety and environmental (HSE) aspects in detail. International regulation is summarised by Doctor *et al* (2005) and also by Omata (2011), who gives more focus, however, to how Japanese regulation relates to international. Vermeulen (2011) has a chapter on the carbon footprint of the CO₂ Liquid Logistic Shipping Concept (LLSC) proposed in that study and a number of other publications include CO₂ emissions of the transport system as a factor for comparison between pipeline and shipping systems. The CO₂ LLSC project commissioned a quantitative risk assessment of its proposed facilities and operations from Det Norske Veritas (DNV) (Koers and de Looij, 2011) and combined this with consideration of dynamic hazards in a separate report (ter Mors, 2011). The key points on these aspects are summarised in the following sections.

6.1 Regulations on CO₂ shipping

There are no regulations specific to transport of CO₂ by ship (Doctor *et al*, 2005) and, in Europe, there are presently no specific guidelines for such transport either (Mikunda *et al*, 2011). However, offshore transport of CO₂ including shipping is covered, in general, by the United Nations Convention on the Law of the Sea (UNCLOS) and trans-boundary movement and geological storage of CO₂ offshore is controlled under the London Protocol as an exception to its general principles (Doctor *et al*, 2005; Omata, 2011).

Trans-boundary shipping of CO₂ would have to comply with international transport regulations falling under the UN Recommendations of Transport of Dangerous Goods: Model Regulations, although CO₂ in gaseous or liquid form is classed as non-toxic and non-flammable (Doctor *et al*, 2005).

The design of ships to carry liquefied gases such as LPG or LNG must comply with the International Gas Carrier (IGC) Codes (IMO, 2014) and these would also be appropriate for liquid CO₂ carriers (Mitsubishi Heavy Industries, 2004).

6.2 Carbon footprint, CO₂ emissions of shipping systems

Vermeulen (2011) reports on life-cycle analysis on a case study for the proposed CO₂ LLSC including direct emissions and indirect emissions due to generation of electricity consumed. For a network case and for simple source to sink cases, each involving shipping, this indicated total GHG emissions equivalent to around 8% of the CO₂ transported. Mitsubishi Heavy Industries (2004) show how the emissions from shipping vary with transport distance ranging from 2.5% for 200 km to 18% for 12,000 km, the variation due to increasing boil-off gas and fuel emissions with distance. Other publications give lower figures for CO₂ equivalent (CO₂e) emitted per unit CO₂ transported, for example, 1.6% (Roussanaly *et al*, 2013).

These differences are likely to be from differences in system boundaries and in assumptions on carbon intensity of electricity supplied, particularly for the energy-intensive liquefaction process. For example, Aspelund, Mølnevik and de Koeijer (2006) estimate 1.4% CO₂e emitted per unit CO₂ transported from a ship transport system if the electricity required is supplied from a generator with 90% carbon capture, but around 5% relative emission if supplied from a combined-cycle gas turbine without carbon capture.

6.3 HSE aspects

6.3.1 Risk assessment

The CO₂ LLSC project commissioned a quantitative risk assessment (QRA) of its proposed facilities and operations from DNV, reported by Koers and de Looij (2011). This report reviews, fairly comprehensively, the hazardous properties of CO₂, likely modes of release and previous incidents involving CO₂ in its introduction before reporting detailed risk assessments for each element of the proposed CO₂ transport chain, including both high pressure pipeline and shipping options for offshore transport. Some key points are summarised below with information from supporting references where appropriate.

CO₂ is often incorrectly considered as an asphyxiant gas only, however, it can also be toxic at high levels, even when enough oxygen is present to avoid asphyxia. Statutory occupational exposure limits vary with jurisdiction; in the UK the current Workplace Exposure Limits are 5,000ppm (5%) for 8-hour reference period and 15,000ppm (15%) for 15-minute reference period (HSE, 2014).

Koers and de Looij (2011) describe the mechanisms of potential release of CO₂ in some detail. Initial discharge behaviour on any loss of containment depends on the pressure differential, the nature of containment failure (catastrophic rupture or smaller leak), the phase of CO₂ released and the receiving medium (air, water, underground). They note and describe the complications and additional hazards that the formation of solid CO₂ may add and include this in their modelling of dispersion processes. They also note the potential hazard of a high velocity, two phase jet of cold gas and solid CO₂ resulting on loss of containment that could lead to severe injuries, however, they do not include this in their risk calculations due to the short range of such effects and low likelihood of personnel presence in the range.

Previous incidents reviewed by Koers and de Looij (2011) involving CO₂ include fire extinguisher incidents (both portable and in building extinguisher systems), pipeline incidents (in USA 1990-2001, 0.33 incidents/1000km/year), two examples of pressure vessel failures, and natural outgassing incidents from CO₂ saturated lakes. A secondary hazard is noted, also mentioned by Giles (2012), where combustion engines may stop running when exposed to high CO₂ concentrations, potentially affecting rescue vehicles and personnel.

No incidents involving loss of containment from CO₂ ships have been reported. Doctor *et al* (2005) summarise the safety record of shipping and observe that tankers, and LNG carriers in particular, have a lower incident rate than shipping in general. This can be expected to hold for CO₂ shipping if similar standards are applied.

The DNV report (Koers and de Looij, 2011) goes on to describe detailed risk assessments and results for each of the elements of the proposed system: liquefaction plant and terminal at emitters, transport by barge, transport by low and high pressure pipelines, CO₂ terminal (including liquefaction and storage) at the seaport, ship transport, offshore offloading. Their overall conclusions were that while all activities could have an effect on the direct surroundings if loss of containment occurred, the risk levels calculated were below national risk criteria (in The Netherlands) in all cases. The highest individual risk levels were in the vicinity of the CO₂ terminals and these need to be suitably distant from vulnerable objects such as housing. It should be noted that these risk levels refer to third party individuals, not to plant personnel who would be present in areas with higher risk levels.

For shipping Koers and de Looij (2011) make conclusions on the consequence of a small (250mm) or large (1100mm) leak from the ship's CO₂ tanks, however, they do not calculate risks as there are no vulnerable objects within the ranges where dangerous CO₂ concentrations may occur – 440m or 950m for a small or large leak respectively. This is acceptable under risk criteria regulations for the location, although clearly ship's crews will be within these ranges.

6.3.2 Dynamic behaviour, operational issues

As well as adopting the DNV report discussed above, the CO₂ LLSC project Safety, Health and Environment report (ter Mors, 2011) covers what it terms dynamic behaviour issues, specifically: overall chain reliability, metallurgic behaviour of chain components, cool down and heat up effects, water-hammer and ship wave interaction. The main report from this project (Vermeulen, 2011) includes a chapter on materials of construction. Giles (2012) covers a high-level hazard identification study with some relevant points concerning potential releases from ships in port. Aspelund, Mølnevik and de Koeijer (2006) outline hazard identification and preliminary hazard and operability studies used to reduce uncertainties in the Statoil/SINTEF project and Aspelund *et al* (2004b) mention the need and precautions to avoid solid CO₂ formation on offshore ship unloading. Some key points on these issues are summarised below.

Design for high reliability is important for economic reasons but also for HSE reasons. Unplanned or increased frequency of maintenance can lead to greater venting of CO₂ with environmental and potentially health consequences. Attention to detail in design of ships and other equipment exposed to seawater, for instance by providing enclosed ducts for cargo pipework and ship systems, can increase reliability (ter Mors, 2011).

Corrosion mechanisms and their minimisation, through correct choice of materials of construction, are discussed in detail by ter Mors (2011) with a summarised version of the same considerations given by Vermeulen (2011). These issues are well understood in the offshore engineering industries and detailed guidance on selection of materials and provision of integrity management systems is available.

Temperature cycling and rapid changes of temperature can lead to thermal stress due to expansion/contraction and to brittle fracture. Equipment and storages in ships and at terminals must be designed to allow for expansion/contraction with suitable fixings, supports and expansion joints. Materials suitable for temperatures down to -78.5°C have been defined, however, the minimum design temperature required may not be as low as this and is still to be defined (ter Mors, 2011). Procedures can be designed to minimise the thermal shock experienced by equipment in normal operations, but designs must allow for emergency situations (Vermeulen, 2011).

Water-hammer can potentially occur during loading and distribution of liquid CO₂ to a ship's tanks and also at offloading for injection. It is caused by a sudden change in fluid velocity such as may occur with rapid opening or closing of valves or start/stop of a pump. It can lead to high pressure surges or to cavitation at low pressure points that may cause damage to equipment. Careful design of equipment and operating procedures to reduce velocity changes, provision of surge relief tanks and/or high and low pressure relief systems can help reduce the incidence of water-hammer (ter Mors, 2011)

Ship design is important to allow offshore offloading operations to be carried out safely in the range of sea and weather conditions expected at the offloading point. The design options for the LLSC project are discussed above at Section 4.4.2. The conventional tanker design is better able than the X-bow design to hold position at the offloading point in harsh weather, being able to operate in 48 knots of wind compared to a maximum of 32 knots for the X-bow. The higher capability of the conventional design reduces the risk of accidental uncoupling during offloading. (Vermeulen, 2011; ter Mors, 2011). Understanding the sea conditions at the intended offloading site and the implications for ship size, freeboard, propulsion/positioning system are critical to designing a safe offshore offloading system (Omata, 2011).

7 Conclusions

This review of available literature on ship transport of CO₂ shows that, while experience of CO₂ shipping is limited to small scales, there is a good level of understanding and definition of what would be needed for scale-up to capacities relevant to CCS or CO₂-EOR. Although many publications note EOR as a potential user of ship transport, there is very little coverage of any specific requirements of EOR, it being included under general CO₂ storage considerations. This may be justified for most of a ship-based liquid CO₂ supply chain, however, there may be requirements specific to EOR at the interface between shipping and reservoir, that is, at the injection stage of the system, which have not been fully considered in the literature.

Shipping of CO₂ is most effective as a liquid at temperature and pressure conditions close to the triple point. The technology required is based on that for other cryogenic liquids such as LPG and LNG. Liquefaction equipment and energy requirement forms a significant proportion of the cost of CO₂ shipping systems; improvements in energy efficiency have been targeted by research projects, various process options are available. Ship proposals are generally based on well-established LPG carrier designs; capacities of up to 100,000 m³ have been proposed, suitable for commercial-scale projects. Ship loading and on-shore offloading employ conventional techniques for cryogenic liquids; however, offshore offloading at a storage/EOR site requires novel techniques and is the main area of technological uncertainty in the transport system.

A number of alternative single point mooring and transfer technologies are available but these may need adapting for CO₂ handling and the optimum is likely to be location-specific. Liquid CO₂ must also be warmed and pumped to a temperature and pressure condition suitable for injection; this will be specific to the well and reservoir and will change with maturity of the storage. The expertise exists to determine conditions and equipment required but this aspect will be difficult to generalise and will be project specific. Injection rates achievable will also be specific to the individual site; however, studies have in most cases assumed rates based on upstream constraints. Optimising CO₂ flow across both transport and injection may have implications on cost that have yet to be properly considered.

Intermediate storage of liquid CO₂ is necessary between liquefaction and ship loading but is not generally considered necessary between ship and injection where this is for storage, intermittent injection being acceptable. However, EOR may require continuous injection or specific injection profiles and hence either intermediate storage at the injection site, or additional ships allowing one to be continuously on-station. This potential requirement has barely been mentioned in the literature and evaluation of its consequences on cost is another significant gap.

There are several areas of liquid CO₂ transport by ship and associated processes where hazards exist, however, all publications reviewed imply or conclude that risks can be controlled to an acceptable level by application of existing engineering practices and procedures under an appropriate regulatory framework. Liquid CO₂ shipping design and operation must comply with the International Gas Carrier Codes that also govern LPG and LNG shipping; these activities have a very good safety record over extensive experience.

The proposed role for shipping in the development of CO₂-EOR, outlined in the introduction (Section 1.1), is supported by the body of literature in general. Shipping of liquid CO₂ at large scale is feasible with known technologies and can provide a transport system that is flexible in

terms of space and time. Shipping allows collection of CO₂ from different source locations or transport hubs and delivery to different storage or EOR sites. It allows for sequential addition of capacity as CCS or EOR is deployed initially and during growth. When storage/EOR projects reach completion, shipping capacity can supply new sites being developed. If CO₂ ships are no longer required, they can be converted for use as LPG carriers maintaining their value.

The capital investment required for a liquid CO₂ shipping system is low compared to the alternative of an offshore pipeline. Together with the flexibility described this means shipping is seen as having relatively low financial risk, which may benefit early CCS or EOR projects. Methodologies for estimating ship-based transport system costs are available but costs cannot easily be generalised, as they are case specific. Overall, the costs of shipping CO₂ can be competitive with pipelines in the right circumstances, generally where volumes are lower and transport distances higher. Several studies have found shipping to be competitive at distance/volume combinations relevant to EOR in the North Sea.

8 Bibliography and additional references

8.1 Bibliography

Note: the full bibliography listed here includes publications not referred to in the report.

ASPELUND, A. (2010). Gas purification, compression and liquefaction processes and technology for carbon dioxide (CO₂) transport. IN: MAROTO-VALER, M. M. (Ed) *Developments and innovation in CCS technology*, Cambridge, Woodhead Publishing Ltd. pp. 383-407.

ASPELUND, A. & GUNDERSEN, T. (2009a). A liquefied energy chain for transport and utilization of natural gas for power production with CO₂ capture and storage – Part 1. *Applied Energy*. 86(6): 781-792.

ASPELUND, A. & GUNDERSEN, T. (2009b). A liquefied energy chain for transport and utilization of natural gas for power production with CO₂ capture and storage – Part 2: The offshore and the onshore processes. *Applied Energy*. 86(6): 793-804.

ASPELUND, A. & GUNDERSEN, T. (2009c). A liquefied energy chain for transport and utilization of natural gas for power production with CO₂ capture and storage – Part 4: Sensitivity analysis of transport pressures and benchmarking with conventional technology for gas transport. *Applied Energy*. 86(6): 815-825.

ASPELUND, A. & JORDAL, K. (2007). Gas conditioning – The interface between CO₂ capture and transport. *International Journal of Greenhouse Gas Control*. 1(3): 343-354.

ASPELUND, A., MØLNVIK, M. J. & DE KOEIJER G. (2006). Ship Transport of CO₂. *Chemical Engineering Research and Design*. 84(9): 847-855.

ASPELUND, A., TVEIT, S. P. & GUNDERSEN, T. (2009). A liquefied energy chain for transport and utilization of natural gas for power production with CO₂ capture and storage – Part 3: The combined carrier and onshore storage. *Applied Energy*. 86(6): 805-814.

ASPELUND, A., SANDVIK, T. E., KROGSTAD, H. & DE KOEIJER, G. (2004a). Liquefaction of captured CO₂ for ship-based transport. IN: WILSON, M., MORRIS, T., GALE, J. & THAMBIMUTHU, K. (Eds.) *7th International Conference on Greenhouse Gas Control Technologies, 2004, Vancouver*, Elsevier Ltd.

ASPELUND, A., WEYDAHL, T., SANDVIK, T. E., KROGSTAD, H.L., WONGRAVEN, R., HENNINGSEN, R., FIVELSTAD, J., OMA N. & HILDEN T. (2004b). Offshore unloading of semi-pressurised CO₂ to an oilfield. IN: WILSON, M., MORRIS, T., GALE, J. & THAMBIMUTHU, K. (Eds.) *7th International Conference on Greenhouse Gas Control Technologies, 2004, Vancouver*, Elsevier Ltd.

ASPELUND, A., KROGSTAD, H., SANDVIK, T. E., (2008). US Patent Application US20080156035, Liquefaction.

ASPELUND, A., KROGSTAD, H., SANDVIK, T. E., FIVELSTAD, J., HENNINGSEN, R., WONGRAVEN, L. R., HILDEN T. & OMA, N. (2008). US Patent Application US20080256959, Vessel.

BAKKEN, B. H. & VON STRENG VELKEN, I. (2008). Linear models for optimization of infrastructure for CO₂ capture and storage. *Transactions of Energy Conversion*. 23(3).

BARRIO, M., ASPELUND, A., WEYDAHL, T., SANDVIK, T. E., WONGRAVEN, L. R., KROGSTAD, H., HENNINGSEN, R. M., MØLNVIK, J. & EIDE, S. I. (2004). Ship-based transport of CO₂. IN: WILSON, M., MORRIS, T., GALE, J. & THAMBIMUTHU, K. (Eds.) *7th International Conference on Greenhouse Gas Control Technologies, 2004, Vancouver*, Elsevier Ltd.

- BERGER, B., KAARSTAD, O. & HAUGEN, H. A. (2004). Creating a large-scale infrastructure for EOR. IN: WILSON, M., MORRIS, T., GALE, J. & THAMBIMUTHU, K. (Eds.) *7th International Conference on Greenhouse Gas Control Technologies, 2004, Vancouver*, Elsevier Ltd.
- CHU, B., CHANG, D. & CHUNG, H. (2012). Optimum liquefaction fraction for boil-off gas reliquefaction system of semi-pressurized liquid CO₂ carriers based on economic evaluation. *International Journal of Greenhouse Gas Control*. 10: 46-55.
- CHU, B., YANG, K. W. & CHANG, D. (2011). Controlled cargo handling with piston fluid for pressurized liquid CO₂ Carrier. IN: GALE, J., HENDRIKS, C. & TURKENBERG, W. (Eds.) *10th International Conference on Greenhouse Gas Control Technologies, 2011, Amsterdam*. *Energy Procedia*, 4: 3048-3055. Elsevier Science BV.
- DECARRE, S., BERTHIAUD, J., BUTIN, N. & GUILLAUME-COMBECAVE, J.-L. (2010). CO₂ maritime transportation. *International Journal of Greenhouse Gas Control*. 4(5): 857-864.
- DOCTOR, R., PALMER, A., COLEMAN, D. L., DAVISON, J., HENDRIKS, C., KAARSTAD, O., OZAKI, M. & AUSTELL, M. (2005). Transport of CO₂. IN: PICHES-MADRUGA, R. & TIMASHEV, S. (Eds.) *IPPC Special Report on Carbon dioxide Capture and Storage*. IPCC. pp179-193.
- GILES, C. (2012). *Peterhead CO₂ importation feasibility study*. Petrofac Engineering Ltd. Report number: JU-12966A-REP-A-0001.
- HAUGEN, H. A., ELDRUP, N., BERNSTONE, C., LILJEMARK, S., PETTERSSON, H., NOER, M., HOLLAND, J., NILSSON, P. A., HEGERLAND, G. & PANDE, J. O. (2009). Options for transporting CO₂ from coal fired power plants Case Denmark. IN: BRAITSCH, J. (Ed.) *9th International Conference on Greenhouse Gas Control Technologies, 2009, Washington DC*. *Energy Procedia*, 1: 1665-1672. Elsevier Science BV.
- HEGERLAND, G., JORGENSEN, T. & PANDE, J. O. (2004). Liquefaction and handling of large amounts of CO₂ for EOR. IN: WILSON, M., MORRIS, T., GALE, J. & THAMBIMUTHU, K. (Eds.) *7th International Conference on Greenhouse Gas Control Technologies, 2004, Vancouver*, Elsevier Ltd.
- ISO-TRYKÄRI, M., RAURAMO, J. & PEKKANEN, E. (2011). FINNCAP - Meri-Pori CCS demonstration project. IN: GALE, J., HENDRIKS, C. & TURKENBERG, W. (Eds.) *10th International Conference on Greenhouse Gas Control Technologies, 2011, Amsterdam*. *Energy Procedia*, 4: 5599-5606. Elsevier Science BV.
- JUNG, J.-Y., HUH, C., KANG, S.-G., SEO, Y. & CHANG, D. (2013). CO₂ Transport Strategy for the Offshore CCS in Korea. IN: DIXON, T. (Ed.) *11th International Conference on Greenhouse Gas Control Technologies, 2013, Kyoto*. *Energy Procedia*, 37: 3242-3249. Elsevier Ltd.
- JUNG, J.-Y., HUH, C., KANG, S.-G., SEO, Y. & CHANG, D. (2013). CO₂ transport strategy and its cost estimation for the offshore CCS in Korea. *Applied Energy*. 111: 1054-1060.
- MITSUBISHI JUKOGYO KK (2002). Japanese Patent JP2004125039-A; *Carbon dioxide handling involves using liquefied petroleum gas ship for conveying carbon dioxide*, Mitsubishi Jukogyo KK (Mito-C).
- KOERS, P. & DE LOOIJ, M. (2011). *Safety study for Liquid Logistics Shipping Concept*. Rotterdam, Det Norske Veritas BV. Report number: 12TUIBY-3
- KOKUBUN, N., KO, K. & OZAKI, M. (2013). Cargo conditions of CO₂ in shuttle transport by ship. IN: DIXON, T. (Ed.) *11th International Conference on Greenhouse Gas Control Technologies, 2013, Kyoto*. *Energy Procedia*, 37: 3160-3167. Elsevier Ltd.
- KROGH, E., NILSEN, R. & HENNINGSEN, R. (2012). Liquefied CO₂ Injection Modelling. IN: *6th Trondheim CCS Conference, 2012, Trondheim*. *Energy Procedia*, 23: 527-555. Elsevier Ltd.

- KUJANPÄÄ, L., RAURAMO, J. & ARASTO, A. (2011). Cross-border CO₂ infrastructure options for a CCS demonstration in Finland. IN: GALE, J., HENDRIKS, C. & TURKENBERG, W. (Eds.) *10th International Conference on Greenhouse Gas Control Technologies, 2011, Amsterdam. Energy Procedia*, 4: 2425-2431. Elsevier Science BV.
- LEE, S. G., CHOI, G. B., YOON, E. S., HAN, C. & LEE, J. M. (2012). Modeling and Simulation of Ship Transport of CO₂. IN: DIXON, T. (Ed.) *11th International Conference on Greenhouse Gas Control Technologies, 2013, Kyoto. Energy Procedia*, 31: 785-789. Elsevier BV.
- LEE, U., LIM, Y., LEE, S., JUNG, J. & HAN, C. (2012). CO₂ Storage Terminal for Ship Transportation. *Industrial & Engineering Chemistry Research*. 51(1): 389-397.
- LEE, U., YANG, S., JEONG, Y. S., LIM, Y., LEE, C. S. & HAN, C. (2012). Carbon Dioxide Liquefaction Process for Ship Transportation. *Industrial & Engineering Chemistry Research*. 51(46): 15122-15131.
- MITSUBISHI HEAVY INDUSTRIES LTD. (2004). *Ship Transport of CO₂*. Cheltenham, IEA-GHG. Report number: PH4/30.
- MIKUNDA, T., VAN DEURZEN, J., SEEBREGTS, A., KERSSEMAKERS, K., TETTEROO, M. & BUIT, L. (2011). Towards a CO₂ infrastructure in North-Western Europe: Legalities, costs and organizational aspects. IN: GALE, J., HENDRIKS, C. & TURKENBERG, W. (Eds.) *10th International Conference on Greenhouse Gas Control Technologies, 2011, Amsterdam. Energy Procedia*, 4: 2409-2416. Elsevier Science BV.
- NAM, H., LEE, T., LEE, J., LEE, J. & CHUNG, H. (2013). Design of carrier-based offshore CCS system: Plant location and fleet assignment. *International Journal of Greenhouse Gas Control*. 12: 220-230.
- OGDEN, J. & JOHNSON, N. (2010). Techno-economic analysis and modeling of carbon dioxide (CO₂) capture and storage (CCS) technologies. IN: MAROTO-VALER, M. M. (Ed) *Developments and innovation in CCS technology*, Cambridge, Woodhead Publishing Ltd. pp. 27-63.
- OMATA, A. (2011). *Preliminary Feasibility Study on CO₂ Carrier for Ship-based CCS*. Chiyoda Corporation and GCCSI. Report number: CCSC-RPT-10-002
- OMATA, A. (2012a). *Phase 2 – unmanned offshore facility. Preliminary Feasibility Study on CO₂ Carrier for Ship-based CCS*. Chiyoda Corporation and GCCSI. Report number: CCSC-RPT-00-002
- OMATA, A. (2012b). *Storage Site Identification beyond the Japanese Continental Shelf. Preliminary Feasibility Study on CO₂ Carrier for Ship-based CCS*. Chiyoda Corporation and GCCSI. Report number: CCSC-RPT-00-003
- OZAKI, M. & OHSUMI, T. (2011). CCS from multiple sources to offshore storage site complex via ship transport. IN: GALE, J., HENDRIKS, C. & TURKENBERG, W. (Eds.) *10th International Conference on Greenhouse Gas Control Technologies, 2011, Amsterdam. Energy Procedia*, 4: 2992-2999. Elsevier Science BV.
- OZAKI, M., OHSUMI, T. & KAJIYAMA, R. (2013). Ship-based Offshore CCS Featuring CO₂ Shuttle Ships Equipped with Injection Facilities. IN: DIXON, T. (Ed.) *11th International Conference on Greenhouse Gas Control Technologies, 2013, Kyoto. Energy Procedia*, 37: 3184-3190. Elsevier Ltd.
- OZAKI, M., DAVISON, J. & MINAMIURA, J. (2004). Marine Transportation of CO₂. IN: WILSON, M., MORRIS, T., GALE, J. & THAMBIMUTHU, K. (Eds.) *7th International Conference on Greenhouse Gas Control Technologies, 2004, Vancouver*, Elsevier Ltd.
- ROUSSANALY, S., BUREAU-CAUCHOIS, G. & HUSEBYE, J. (2013). Costs benchmark of CO₂ transport technologies for a group of various size industries. *International Journal of Greenhouse Gas Control*. 12: 341-350.

- ROUSSANALY, S., HOGNES, E. S. & JAKOBSEN, J. P. (2013). Multi-criteria analysis of two CO₂ transport technologies. IN: DIXON, T. (Ed.) *11th International Conference on Greenhouse Gas Control Technologies, 2013, Kyoto. Energy Procedia*, 37: 2981-2988. Elsevier Ltd.
- ROUSSANALY, S., JAKOBSEN, J. P. HOGNES, E. H. & BRUNSVOLD, A. L. (2013). Benchmarking of CO₂ transport technologies: Part I—Onshore pipeline and shipping between two onshore areas. *International Journal of Greenhouse Gas Control*. 19: 584-594.
- SEO, Y., CHANG, D., JUNG, J.-Y., HUH, C. & KANG, S.-G. (2013). Economic Evaluation of Ship-based CCS with Availability. IN: DIXON, T. (Ed.) *11th International Conference on Greenhouse Gas Control Technologies, 2013, Kyoto. Energy Procedia*, 37: 2511-2518. Elsevier Ltd.
- SKAGESTAD, R., MATHISEN, A., ELDRUP, N.H. & HAUGEN, H.A. (2011). CO₂ transport from sources to storage in the Skagerrak/Kattegat region. IN: GALE, J., HENDRIKS, C. & TURKENBERG, W. (Eds.) *10th International Conference on Greenhouse Gas Control Technologies, 2011, Amsterdam. Energy Procedia*, 4: 3016-3023. Elsevier Science BV.
- SVENSSON, R., ODENBERGER, M., JOHNSON, F. & STRÖMBERG, L. (2004a). Transportation systems for CO₂ – application to carbon capture and storage. *Energy Conversion and Management*. 45(15-16): 2343-2353.
- SVENSSON, R., ODENBERGER, M., JOHNSON, F. & STRÖMBERG, L. (2004b). Transportation Infrastructure for CCS - Experiences and Expected Development. IN: WILSON, M., MORRIS, T., GALE, J. & THAMBIMUTHU, K. (Eds.) *7th International Conference on Greenhouse Gas Control Technologies, 2004, Vancouver, Elsevier Ltd.*
- TER MORS, Y. (2011). *Safety, Health and Environment (SHE) Report. CO₂ Liquid Logistics Shipping Concept*. Tebodin Netherlands BV, Vopak, Anthony Veder and GCCSI. Report number: 3112003.
- TETTEROO, M. & VAN DER BEN, C. (2011). *CINTRA Business Model. CO₂ Liquid Logistics Shipping Concept*. Vopak, Anthony Veder and GCCSI.
- VERMEULEN, T. N. (2011). *Overall Supply Chain Optimization. CO₂ Liquid Logistics Shipping Concept*. Tebodin Netherlands BV, Vopak, Anthony Veder and GCCSI. Report number: 3112001.
- WHITTAKER, S. & E. PERKINS (2013). *Technical aspects of CO₂ enhanced oil recovery and associated carbon storage*. GCCSI.
- WILDBOLZ, C. (2007). *Life Cycle Assessment of Selected Technologies for CO₂ Transport and Sequestration*. Thesis, (Diploma). Swiss Federal Institute of Technology.
- YOO, B.-Y., CHOI, D.-K., KIM, H.-J., MOON, Y.-S., NA, H.-S. & LEE, S.-G. (2013). Development of CO₂ terminal and CO₂ carrier for future commercialized CCS market. *International Journal of Greenhouse Gas Control*. 12: 323-332.
- YOO, B.-Y., LEE, S.-G., RHEE, K.-P., NA, H.-S. & PARK, J.-M. (2011). New CCS system integration with CO₂ carrier and liquefaction process. IN: GALE, J., HENDRIKS, C. & TURKENBERG, W. (Eds.) *10th International Conference on Greenhouse Gas Control Technologies, 2011, Amsterdam. Energy Procedia*, 4: 2308-2314. Elsevier Science BV.
- ZEP (2011). *The Costs of CO₂ Transport*. Brussels, European Technology Platform for Zero Emission Fossil Fuel Power Plants.

8.2 Additional references

Web sites and other sources referred to in the text but not forming part of the bibliography are listed below:

ANTHONY VEDER, (2014). Company website, accessed 01/08/2014:

<http://www.anthonyveder.com/fleet/coral-carbonic/>

HEUCKE, U. (2014). Personal communication *via* Gordon Sim, SCCS from Ulrich Heucke, Linde AG.

HSE, (2014). Health and Safety Executive website, accessed 22/08/2014:

<http://www.hse.gov.uk/carboncapture/carbondioxide.htm>

IMO, (2014). International Code for the Construction and Equipment of Ships Carrying Liquefied Gases in Bulk (IGC Code). International Maritime Organisation web page, accessed 29/08/2014:

<http://www.imo.org/OurWork/Environment/PollutionPrevention/ChemicalPollution/Pages/IGCCode.aspx>

IM SKAUGEN, (2104). Article on company website, accessed 30/07/2014:

http://www.skaugen.com/index.php?option=com_content&view=article&id=139:main-article-history&catid=49:history&Itemid=134

LARVIK, (2014). Company website, accessed 30/07/2104: <http://www.larvik-shipping.no/>

NOV/APL, 2014. Company website, accessed 31/07/2014:

<http://fps.nov.com/subsea/mooring-systems/submerged-turret-loading>

YARA, (2013). Press release on company website, accessed 30/07/2014:

http://www.yara.com/media/news_archive/Yara_co2_ships.aspx

Appendix 1 – Scope Document

WP15: Ship transport of CO₂ for EOR – Literature Survey

Work Package Rationale

Transport of CO₂ by ship may fulfil a key role in the development of CO₂-EOR in the North Sea. Shipping of liquefied CO₂ already occurs, albeit at a limited scale, to service the industrial gases market. Use of shipping to supply early-phase CO₂-EOR projects may bring benefits including the flexibility to use equipment in several projects, ability to collect from existing industrial sources and moderate capital costs compared to new pipelines. A number of studies have focussed on use of shipping for CO₂ transport in the context of CCS; this work package will assess the available literature, review appropriate studies in detail and produce a succinct report summarising the main points of note for CO₂-EOR interests.

Key Aims

- Determine the extent and scope of literature on transport of CO₂ by ship.
- Review a selection of available literature to extract and report the key findings of interest for CO₂-EOR focussing on options for loading/offloading and comparative costs against other transport modes.

Work Package Scope

- Carry out comprehensive literature searches to build bibliography on CO₂ shipping.
- Assess available literature for relevance and select items for detailed review.
- Review selected papers extracting information to address the following questions:
 - What has been the purpose of studies?
 - What are the key findings of relevance for CO₂-EOR (role for shipping, technology, cost, HSE, regulation, other)?
 - What is currently established for CO₂ shipping (number, scale, technologies)?
 - What proposals exist for use of shipping for CCS or CO₂-EOR?
 - What methods/technologies for loading/offloading are established and what proposed for CCS or CO₂-EOR?
 - What cost estimates for CO₂ shipping exist and what comparisons with other transport modes have been made?

Outputs

- Bibliography on ship transport of CO₂.
- Succinct report summarising the extracted information addressing the questions above.

Resource

Internal technical resource from SCCS Scientific Research Officer.

Estimated cost/work and duration: £10, 250 (1 month Salary +FEC (£8.2k), plus 1 additional week for addressing comments should it be required), 1 month work over a 2 month duration.